



▶ User Guide for the Polycom®
CX300 Desktop Phone

Microsoft® Lync™ 2010 Edition

Trademark Information

POLYCOM®, the Polycom “Triangles” logo and the names and marks associated with Polycom’s products are trademarks and/or service marks of Polycom, Inc. and are registered and/or common law marks in the United States and various other countries. All other trademarks are property of their respective owners. No portion hereof may be reproduced or transmitted in any form or by any means, for any purpose other than the recipient’s personal use, without the express written permission of Polycom.

Microsoft, Lync, MS-DOS, Windows, WindowsServer, Windows Vista, and Windows XP are either registered trademarks or trademarks of Microsoft Corporation in the United States and/or other countries.

Patent Information

The accompanying product is protected by one or more U.S. and foreign patents and/or pending patent applications held by Polycom, Inc. and/or one or more of its licensors.

Copyright Notice

The software contained in this product may be copyrighted by Polycom and/or one or more of its licensors.

Copyright © 2010 Microsoft Corporation. All rights reserved.

Copyright © 2010 Polycom, Inc. All rights reserved.

© 2011 Polycom, Inc. All rights reserved.

Polycom, Inc.
4750 Willow Road
Pleasanton, CA 94588-2708
USA

No part of this document may be reproduced or transmitted in any form or by any means, electronic or mechanical, for any purpose, without the express written permission of Polycom, Inc. Under the law, reproducing includes translating into another language or format.

As between the parties, Polycom, Inc., retains title to and ownership of all proprietary rights with respect to the software contained within its products. The software is protected by United States copyright laws and international treaty provision. Therefore, you must treat the software like any other copyrighted material (e.g., a book or sound recording). Every effort has been made to ensure that the information in this manual is accurate. Polycom, Inc., is not responsible for printing or clerical errors. Information in this document is subject to change without notice.

About This Guide

Thank you for choosing the Polycom® CX300 Desktop Phone which enables a new era in unified communications currently unavailable with traditional desktop phones. Connecting a Polycom CX300 phone to a computer running Microsoft® Lync™ 2010 allows you to place and receive telephone calls over your IP network connection. For more information on what's new in Microsoft Lync 2010, refer to

<http://www.microsoft.com/communicationsserver/en/us/whats-new.asp>

This User Guide provides everything you need to quickly use your new phone. Verify with your system administrator that the network is prepared for configuring your Polycom CX300 phone, you are provisioned in Microsoft Lync 2010, and your network is correctly configured. As well, read the [Parts List](#) and [Safety Notices](#) sections in this guide before you set up and use the Polycom CX300 phone.

Changes to This Guide

The following sections are new for this edition:

- [Connecting to Microsoft Lync 2010](#) on page 1-7

Contents

About This Guide	iii
Changes to This Guide	iii
1 Getting Started with Your Phone	1-1
Parts List	1-2
Assembling Your Phone	1-2
Connecting the Handset and Optional Headset	1-2
Connecting the Phone to Your Computer	1-4
Features of Your Phone	1-5
Before You Use Your Phone	1-7
Phone Location	1-7
Connecting to Microsoft Lync 2010	1-7
Configuring Microsoft Lync 2010 for the Polycom CX300 Desktop Phone	1-7
Changing the Phone Settings	1-8
Switching Where Audio is Played	1-10
Usage Guidelines	1-10
2 Using the Basic Features of Your Phone	2-1
Placing Calls	2-2
Answering Calls	2-4
Switching Where You Receive Audio During Calls	2-4
Ending Calls	2-5
Redialing Numbers	2-5
Redirect Calls	2-6
Muting the Microphone	2-6
Adjusting the Volume	2-6
Putting Calls on Hold	2-6
Forwarding Calls	2-7
Using Voice Mail	2-7
Using Your Phone with Microsoft Office Live Meeting	2-8

Changing the Language 2-8
Restarting Your Phone 2-9

3 Troubleshooting Your Phone 3-1

Power and Startup 3-1
Controls, Placing and Receiving Calls 3-2
Access to Systems 3-3
Audio 3-3
Microsoft Lync 2010 3-4

Safety Notices Safety Notices-1

Getting Started with Your Phone

This chapter provides basic installation instructions and information for obtaining the best performance with the Polycom® CX300 desktop phone.

The Polycom CX300 phone provides a flexible and efficient means to access the advanced communication functions of Microsoft® Lync™ 2010.

The Polycom CX300 supports advanced functionality including:

- High definition audio for best possible voice calls
- Convenient buttons for controlling calls
- Driver-less plug and play installation

This chapter contains:

- [Parts List](#)
- [Assembling Your Phone](#)
- [Features of Your Phone](#)
- [Before You Use Your Phone](#)

To read about the phone's basic features, refer to [Using the Basic Features of Your Phone](#) on page 2-1.

If you require additional information or assistance with your new phone, contact your system administrator.



Before you connect the Polycom CX300 desktop phone to your computer, you must have Microsoft Lync 2010 (version 4.0.7457.0 or later) installed and running on your computer. If Microsoft Lync 2010 (version 4.0.7457.0 or later) is not installed on your computer, the "Sign In" message appears on the phone's display. In this state, you can use the phone as an audio device only; you cannot place any calls.

Your computer must be running Windows XP Service Pack 3, Windows Vista Service Pack 1, and Windows 7 Service Pack x.

The Polycom CX300 desktop phone is also a compatible audio device for Microsoft Office Live Meeting.

No additional device drivers or software are required to use your Polycom CX300 desktop phone.

Parts List

The following components are included in your Polycom CX300 package:

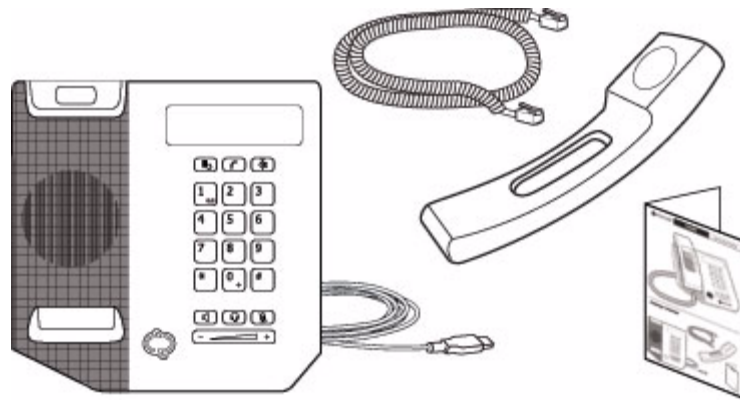

- 1 Polycom CX300 desktop phone with attached USB Cable
- 2 Handset
- 3 Handset cord
- 4 Quick Start Guide and registration card

Check this list before installation to ensure that you have received each item. If you are missing any items, contact your system administrator.

Assembling Your Phone

This section describes how to assemble your Polycom CX300 desktop phone:

- Connect handset and headset (optional)
- Connect the Polycom CX300 phone to your computer

If your phone is already assembled and connected to your computer, go directly to [Features of Your Phone](#) on page 1-5.

Connecting the Handset and Optional Headset

To connect the handset and optional headset:

- 1 Connect one end of the handset cord to the handset and the other end of the cord to the handset jack on the back of the phone.

-
- 2 (Optional.) Connect the headset cord to the headset jack on the back of the phone.

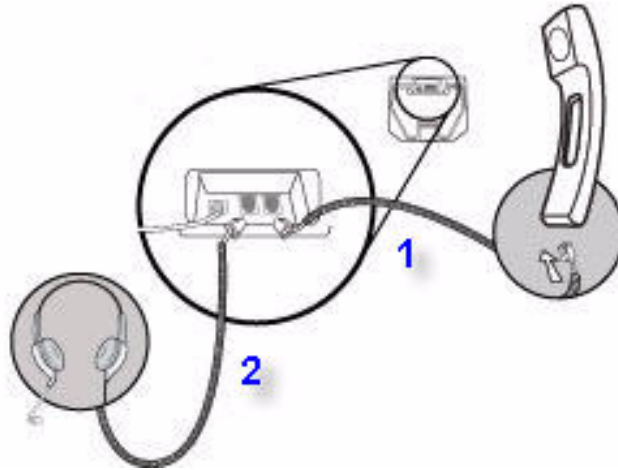

A list of supported headsets is available in the Voice section of Polycom's Support web site at <http://www.polycom.com/support/voicedocumentation/>.



If headsets are deployed in high electrostatic environments where users frequently disconnect and re-connect the headset to the phone, it is possible that the phone can be damaged by electrostatic discharge (ESD).

You should take precautions to avoid excessive electrostatic buildup in your environment. This can include humidity control and removal of synthetic materials near the phone location. Antistatic spray applied to carpets in the workplace can reduce the level of electrostatic buildup.

Connecting the Phone to Your Computer

To connect the Polycom CX300 desktop phone to your computer:

>> Connect the USB cable (attached to the base unit) to a USB 1.1 or 2.0 port on your computer.

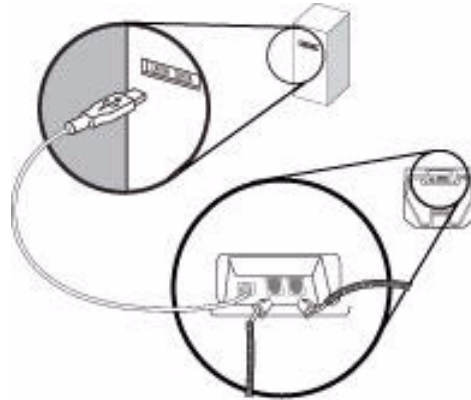

The Polycom CX300 will not work if it is connected to a bus-powered USB hub.

Upon powering up your phone, a splash screen appears. An example is shown below:

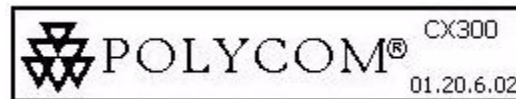

Features of Your Phone

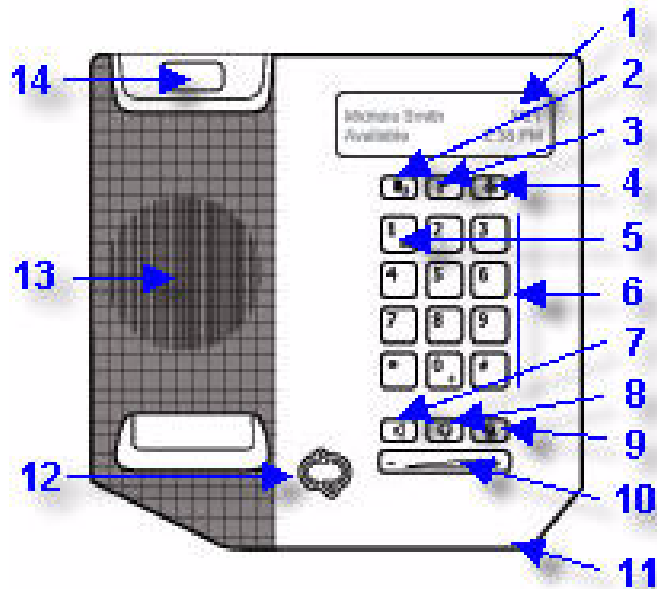

The features of the Polycom CX300 desktop phone are:

- 1 Graphic Display** – Shows information about calls, messages, time, date, and other relevant data.

An example of the idle screen is shown below.









Lindsay Sharp	7/15
Available	11:22 AM

The display backlight is lit when:

- You are in a call.
- You are changing the phone setting using the dial pad. For more information, refer to [Changing the Phone Settings](#) on page 1-8.
- Microsoft Lync 2010 is interacting with the phone.
- An application running on your computer is streaming audio to/from the phone.

After 30 seconds of inactivity, the display backlight turns off.

- 2 Redial Key**  – Dials most recently dialed contact.

- 3 **Hold Key**  – Holds an active call or resumes a held call.
You can also use the **Hold** key to clear a phone number that you have entered before you have completed the call or to toggle between two active calls.
- 4 **Delete Key**  – Delete displayed data or reject incoming call.
- 5 **Message Waiting Indicator**  – Indicates that there are new unheard messages.
- 6 **Dial Pad** – These 12 keys provide the 10 digits, the 26 alphabetic characters, and special characters available in context-sensitive applications.
- 7 **Speakerphone Key**  – Allows for hands-free communication during calls.
- 8 **Headset Key**  – Allows you to place and receive calls through a connected headset (optional accessory).
- 9 **Microphone Mute Key**  – Mutes local microphone during calls so that others cannot hear you.
- 10 **Volume Key**  – Used to adjust the volume of the handset, speakerphone, and headset speaker during a call, and the ringer if not in a call.
- 11 **Hands-free Microphone** – Picks up audio during hands-free calls.
- 12 **Presence Status Indicator**  – Indicates your presence state.
- 13 **Speaker** – For ringer and hands-free audio output.
- 14 **Hookswitch**

Before You Use Your Phone

Phone Location

Place your phone in a well-ventilated, flat, level, clean, and dry location near your computer.

Connecting to Microsoft Lync 2010

After you have plugged the USB (connected to your phone) into your computer, the CX300 splash screen appears.

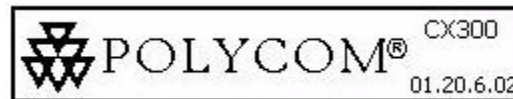

If the Microsoft Lync 2010 or Microsoft Office Communications Server 2007 R2 is running on your computer, but you are not signed in, the Sign In screen appears.

The image shows a rectangular box with a black border containing the text "Sign in to Microsoft Lync". The text is centered and uses a bold, sans-serif font.

Configuring Microsoft Lync 2010 for the Polycom CX300 Desktop Phone

Before using your phone, you must verify that the Microsoft Lync 2010 audio settings are properly configured to route incoming and outgoing audio to and from your phone.

To verify or configure Microsoft Lync 2010:

- 1 Start the **Microsoft Lync 2010** application.
- 2 In the **Microsoft Lync 2010** title bar, click the down arrow near the upper left corner.
- 3 Select **Tools**, click **Set up Audio and Video...**, and then follow the instructions in the Audio and Video Device Setup wizard.
 - a In the wizard, ensure that the **Speaker** and **Microphone** device options are both set to **Polycom CX300** for the **Handset or Headset** setup pages. Click **Next**.
 - b Ensure that the **Speaker/Microphone or Speakerphone** device options are both set to **Polycom CX300**. (You may need to select **Custom** in the top text box to enable you to properly select the speaker and microphone.) Click **Next**.

- c If you want ringing and other sounds made by your computer to output from the Polycom CX300 earpiece, select the Polycom CX300 to be the device for the **Sounds** setup page. Otherwise ensure that your PC sound output device is selected.
- d Click **Finish** to exit the wizard.



Contact your system administrator to ensure your account is configured for Enterprise Voice mode.

Changing the Phone Settings

You can modify the volume and text display settings of your phone. These settings can be accessed while **5=settings** is displayed on the splash screen, which is displayed on the phone at startup. **5=settings** is displayed for 10 seconds.

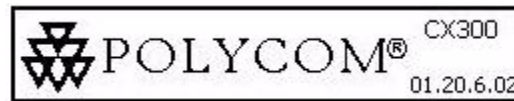

If the language setting of Microsoft Lync 2010 is not English, the **5=settings** is not displayed with the splash screen. However, you can still access the phone settings if you press the 5 dial pad key during the first 10 seconds of the splash screen's display.

Press the * dial pad key to return to a previous menu or exit phone settings menu.



Do not disconnect the phone from the computer that is running Microsoft Lync 2010 when making changes to the phone settings. This could result in data corruption.

This section contains instructions for:

- [Volume Key Response Rate](#)
- [Call Volume Setting](#)
- [Text Size Setting](#)

Volume Key Response Rate

The volume key response rate sets how fast the volume changes after the user's key press and how fast the phone's volume increases or decreases in response to a user's key press.

To change the volume key response rate settings:

- 1 After you press the 5 dial pad key during startup, press 1 to continue with device settings, and then press 1 again to continue.
- 2 Press 1 for volume key settings.
The message "You can adjust the rate which volume will increase or decrease when holding down the volume buttons." is displayed.
Continue pressing 1 to read through the message.
- 3 Select a volume press response rate.
The possible values are 1 (slow), 2, (standard), and 3 (fast).
- 4 When prompted with "Use the <your choice of> volume button response rate? YES (1) Cancel (*)", press the appropriate key.
If you press 1, the volume key press response rate is saved.
- 5 Press * to exit.

Call Volume Setting

The volume can be set to one of two levels:

- The system default level
- The level that was used in the previous call

To change the volume settings of your call:

- 1 After you press the 5 dial pad key during startup, press 1 to continue with device settings, and then press 1 again to continue.
- 2 Press 2 for more options, and then press the 1 dial pad key for call volume settings.
The message "You can restore volume to default, or preserve volume level from your last call."
Continue pressing 1 to read through the message.
- 3 Press 1 to preserve the level from previous call or 2 for default level.
The message "Each call starts with <your choice of> volume level." is displayed.
- 4 Press * to exit.

Text Size Setting

Two font sizes are supported for most languages:

- A normal size
- A larger size (factory default)



The text size setting applies to all languages except Japanese, Chinese, Korean, Hebrew, Thai, Arabic, and Devanagari.

To change the size of the display text:

- 1 After you press the 5 dial pad key during startup, press 1 to continue with device settings, and then press 1 again to continue.
- 2 Press 2 twice, and then press the 1 dial pad key for text size settings.
The message “Text can be displayed in two sizes for some languages. This is normal size text. This is large.”
Continue pressing 1 to read through the message.
- 3 Press 1 to select normal size or 2 to select large size.
The message “<Your choice> size text selected.” is displayed.
- 4 Press * to exit.

Switching Where Audio is Played

During a call, you can switch where call’s audio is played out. In the Microsoft Lync 2010 window on your computer, click the **Switch Audio Device** icon, and then select another entry in the list.

Usage Guidelines

To navigate through menus, to enter data, and instructions on how to use Microsoft Lync 2010, refer to the Microsoft Lync 2010 help and documentation

Using the Basic Features of Your Phone

Your Polycom® CX300 desktop phone is designed to be used like a regular handset. Calls may be placed or answered using the phone or the Microsoft® Lync™ client window.

Once installed and configured, the Polycom CX300 desktop phone and Microsoft Lync 2010 work in a tightly integrated manner. Voice input and audio output will be through the Polycom CX300 phone's handset or speakerphone (or optionally connected headset) whenever Microsoft Lync 2010 is used.

All actions to handle calls—for example, placing, answering, and holding—are performed on the Polycom CX300 desktop phone. Other actions use the Polycom CX300 phone keys and the Microsoft Lync 2010 desktop client together.

This chapter provides basic operating instructions for the Polycom CX300 phone. This chapter contains instructions on:

- [Placing Calls](#)
- [Answering Calls](#)
- [Switching Where You Receive Audio During Calls](#)
- [Ending Calls](#)
- [Redialing Numbers](#)
- [Redirect Calls](#)
- [Muting the Microphone](#)
- [Adjusting the Volume](#)
- [Putting Calls on Hold](#)
- [Forwarding Calls](#)
- [Using Voice Mail](#)

This chapter also provide information on:

- [Using Your Phone with Microsoft Office Live Meeting](#)
- [Changing the Language](#)
- [Restarting Your Phone](#)

To troubleshoot issues with the phone, refer to [Troubleshooting Your Phone](#) on page 3-1.

This guide only describes how to use the Polycom CX300 desktop phone with Microsoft Lync 2010. For more information on how to use Microsoft Lync 2010, refer to your Microsoft documentation.

If you require additional information or assistance with your new phone, contact your system administrator.

Placing Calls

Before placing a call to contact, you may want to check their presence status in Microsoft Lync 2010. If their status is Available, go ahead and place the call.

To place a call using your Polycom CX300 desktop phone, dial the number using the dial pad with the handset off-hook or on-hook.

During a call, you can alternate between handset, headset, or speakerphone modes by pressing the **Speakerphone** or **Headset** keys, or picking up the handset. If you are using the handset, press the **Speakerphone** or **Headset** keys before you replace the handset. If you are using the speakerphone or headset, just lift the handset to switch.

Call duration on an active call is monitored through a local call timer. This is visible within the active call window on the graphic display. In the figure below, the call to Sarah Smith has lasted two minutes and twenty seconds so far.

Smith, Sarah	0:02:20
Human Resources Coordina...	



With regard to the placement of emergency calls, consult your system administrator.

To place international calls, enter "+". Press and hold the "0" key for 1.5 seconds. The "0" button must be the first digit pressed for the "+" for international dialing to display. Microsoft Lync 2010 will replace the "+" with the access numbers required to dial an international phone number.

If dialing rules are set up for Microsoft Lync 2010, then these rules also apply to your phone.

To place a call using the handset:

>> Do the following steps in any order:

- Pick up the handset.
- Dial the desired number using the dial pad.

The number appears on the graphic display.

Enter a number to dial:
2033

The numbers will automatically dial once the complete number is entered. To dial out immediately, press the # after you have entered the number.

The dial tone that is played when you are off-hook dialing is either a long or a short tone. The dial tone is long when the speaker is not streaming any sound. The dial tone is short when the speaker is being used for another application or for audio streaming.



If you are off-hook dialing, press the **Hold** key to delete the entire phone number (instead of pressing the **Delete** key multiple times).

If you are on-hook dialing, press the **Hold** key to return to the idle screen.

To place a call using the speakerphone:

The speakerphone is the default audio device. However, if you manually select another device— for example, the headset — the phone remembers your selection. Refer to [Switching Where Audio is Played](#) on page 1-10.

>> Do one of the following steps:

- With the handset on-hook, press the **Speakerphone** key.

When you hear a dial tone, enter the desired number.

- Dial the desired number using the dial pad.

Press the **Speakerphone** key.

To place a call using the headset:

>> Do one of the following steps:

- With the optional headset connected, dial the desired number using the dial pad.

Press the **Headset** key.

- Press the **Headset** key.

When you hear a dial tone, enter the desired number.

Answering Calls

When you get an incoming voice call, Microsoft Lync 2010 displays an audio popup notification in the lower right corner of your computer's display. The popup provides contextual information about the caller to help you decide whether to accept the call, and it provides a variety of controls for handling the call.

When the notification pop-up appears:

- You can answer the call with the Polycom CX300 desktop phone or with Microsoft Lync 2010.
- You can reject the call by pressing the **Delete** key. Depending on the configuration, either the call is sent to your voice mail or the caller receives a message that the call cannot be connected.

To take any other action, you must perform those actions on the Microsoft Lync 2010 client window. Other possible actions could include responding with an instant message, setting your presence status to Do Not Disturb (for the next 30 minutes), or redirecting the call to another number, device, or to your voice mail.



The speakerphone is the default audio device. However, if you manually select another device— for example, the headset — the phone remembers your selection. Refer to [Switching Where Audio is Played](#) on page 1-10.

To answer an incoming call:

>> Do one of the following steps:

- Click the caller's name or phone number in the notification or press the **Speakerphone** key to answer the call using the Polycom CX300 speakerphone.
- Pick up the handset.
- (Optional.) Press the **Headset** key to answer the call using a headset.

Switching Where You Receive Audio During Calls

With Microsoft Lync 2010, you can switch where the audio is received during a call. You can choose from:

- Your handset
- A custom device that you set up in the Microsoft Lync 2010 Audio Device Settings

To switch where the audio is received:

- >> In the Microsoft Lync 2010 conversion window do the following:
- Click the **Switch Audio Device** icon.
 - Select another device from the list.

Ending Calls

To end a call:

- >> Do one of the following steps:
- Replace the handset.
 - Press the **Speakerphone** key if you are using the speakerphone.
 - Press the **Headset** key if you are using the optional headset.

Redialing Numbers

The last placed call is any of the following:

- The call you just completed on your phone
- The call you just completed using Microsoft Lync 2010
- The number you entered on your phone, but the call was unsuccessful
- The number you entered using Microsoft Lync 2010, but the call was unsuccessful



The information about the last call is stored in the computer to which the phone is connected. If you disconnect the phone from one computer and connect it to another computer that is running Microsoft Lync 2010, and then you press the **Redial** key, the phone will redial the last number called based on the information in the second computer.

To redial the last placed call:

- >> Press the **Redial** key.

If you press the **Redial** key and have not previously made any calls, the phone will not respond and no message is displayed.

Redirect Calls

When you receive an incoming call on the Polycom CX300 phone, you can redirect the call by clicking the **Redirect** soft key in the Microsoft Lync 2010 client window. You can choose to:

- Redirect the call to an instant message. A call rejection message is sent to the calling party.
- Redirect the call to voice mail.
- Redirect the call to another phone.

Muting the Microphone

During a call, press the **Microphone Mute** key. The LED on the key indicates that the other contact cannot hear you.

Microphone mute applies to calls using the handset, headset, and speakerphone. You can still hear all other parties while mute is enabled.

To turn off microphone mute, press the **Microphone Mute** key again.

Adjusting the Volume

During a call, if you are using the speakerphone, pressing the **Volume** key adjusts the speaker volume.

During a call, if you are using the handset, pressing the **Volume** key adjusts the handset volume.

During a call, if you are using the headset, pressing the **Volume** key adjusts the headset volume.

If you press the **Volume** key when not in call, the ringer volume is adjusted.

Putting Calls on Hold

During a call, you may place a call on hold. If there is an incoming call while you are in another call, pressing the **Hold** key puts the first call on hold and answers the second call. If you are on a call and there is another call already on hold, pressing the **Hold** key puts the active call on hold and transfers you to the other call that is previously on hold. If there are several calls on hold, you can cycle through the calls by pressing the **Hold** key.

To put all calls on hold at the same time, you must use the Microsoft Lync 2010 client running on your computer.

To put a call on hold:

>> Press the **Hold** key.

Press the **Hold** key again to resume the call.



As using the Hold feature typically generates music or a beeping tone, avoid putting a conference call on hold.

Forwarding Calls

You can configure your Microsoft Lync 2010 to forward all incoming calls to another contact (known as static forwarding).

To enable call forwarding to another contact:

- 1 In the Microsoft Lync 2010 window on your computer, select the **Forwarding** icon to the right of your name.
- 2 On the Forwarding screen, select the forwarding rule that you want to apply.
- 3 If you are forwarding to another contact or phone number, select the contact name that you want to forward your calls to, then select **OK**.

If you want to specify the time period before forwarding the call, use the arrows keys to increase or decrease the time interval in the **Ring for this many seconds before redirecting** field. By default, the call is forwarded immediately.

- 4 On the Forwarding screen, select **OK**.

Using Voice Mail

Your voice mail is saved in a centralized location and may be accessed from your phone.

The presence of new voice mail messages is indicated by a Message Waiting



Indicator on the Polycom CX300



This feature requires that you have access to a Microsoft Exchange 2007 server. Voice mail may not be supported on your particular system. For more information, contact your system administrator.

To listen to voice messages:

- 1 Press and hold down the **1** dial pad key for 1.5 seconds.
- 2 When prompted for your PIN number, enter the number using the dial pad.

The voice mail access feature is configured by your system administrator, who assigns the initial PIN number.

Using Your Phone with Microsoft Office Live Meeting

Your phone can be used as an audio device for Microsoft Office Live Meeting (and other third-party applications).

When you use the Polycom CX300 phone as the audio device for Microsoft Office Live Meeting, the following items should be noted:

- During actual streaming, you will see the handset, headset, or speakerphone graphic indicating which audio device is active. However, the **Speakerphone** or **Headset** key LED will not be turned on.
- You can use the phone for Microsoft Lync 2010 at the same time. Microsoft Lync 2010 uses the volume level that you set for streaming audio for the incoming call tone, even if you previously set a default volume level for calls.
- You cannot mute yourself by pressing the **Microphone Mute** key. The mute controls of the Polycom CX300 phone Microsoft Office Live Meeting are independent of each other. You must use the Microsoft Office Live Meeting mute control on your computer to mute Microsoft Office Live Meeting.

To use the phone to place a call while Microsoft Office Live Meeting is streaming on the phone:

- >> Press the Speakerphone key to put the phone off-hook and place a call.

If the phone is already off-hook, pressing the **Speakerphone** key again places the phone on-hook and returns it to being an audio device. The same process applies when you press the **Headset** key or lift the handset.

Changing the Language

Your phone supports all 38 languages that are supported by Multilingual User Interface Package of Microsoft Lync 2010 and mixed language display. This feature combination can be useful when the Microsoft Lync 2010 language setting differs from the Windows regional setting, because the phone's date/time display follows the operating system settings.

For example, if Microsoft Lync 2010 is set to “Thai” and the Windows operating system is in English, the information on the phone display will be in Thai, except for the date and time, which will be in English.

The phone remembers the last language that was used by Microsoft Lync 2010 and uses English by default.

To select a language for Microsoft Lync 2010:

- 1 Verify that the Multilingual User Interface Package for Microsoft Lync 2010 is installed on your computer.
- 2 In the upper-left corner of the Microsoft Office Communicator title bar, click the down arrow, select **Tools**, and then click **Options**.
- 3 Select **General** tab, and under **Language**, select a language from the drop-down list.
- 4 Click **OK**.
- 5 Close and exit Microsoft Lync 2010.
- 6 Restart Microsoft Lync 2010.

Your phone’s display will now show the displayed text in the language you selected in step 3.

Restarting Your Phone

On rare occasions, your phone may experience a problem that will require it to be restarted. Contact your system administrator before doing so.

To restart the phone:

- >> Unplug the phone from the computer, then plug it back in.

The restart process will begin.

Troubleshooting Your Phone

This chapter presents problems, likely causes, and corrective actions that might occur with your Polycom® CX300 Desktop Phone. Problems are grouped as follows:

- [Power and Startup](#)
- [Controls, Placing and Receiving Calls](#)
- [Access to Systems](#)
- [Audio](#)
- [Microsoft Lync 2010](#)

If you still need assistance, contact your system administrator.

Power and Startup

Symptom	Problem	Corrective Action
There are power issues.	The Polycom CX300 desktop phone has no power.	<p>Do one of the following steps:</p> <ul style="list-style-type: none"> • Verify that no lights appear on the unit when it is powered up. • Verify that the USB port provides power. • Try the phone in another USB port where the power is known to be working. <p>Note: The phone will not work if it is connected to bus-powered USB hub.</p>
The handset appears to be fine, but there is no interaction between the handset and the Microsoft® Communicator "14" client.	There may be problems with your Microsoft Lync 2010 client software or with the Microsoft Lync 2010 software.	Contact your system administrator to ensure your account is configured properly and that your Microsoft Lync 2010 client software and the Microsoft Lync 2010 software are properly installed and configured.

Controls, Placing and Receiving Calls

Symptom	Problem	Corrective Action
The Polycom CX300 keys do not provide call control as described in this guide.	Your Microsoft Lync 2010 client or your Microsoft Lync 2010 account may not be configured correctly.	Contact your system administrator to ensure your account is configured in Enterprise Voice mode.
	Your computer's USB port may not be operating correctly.	Do the following steps: <ul style="list-style-type: none"> • Plug your Polycom CX300 desktop phone into a different USB port on your computer. • Unplug your Polycom CX300 desktop phone, reboot your computer and plug the Polycom CX 300 desktop phone into a different port.
You cannot place a call.	You are not signed into your Microsoft Lync client.	On the computer the CX300 is connected to, sign in to your Microsoft Lync 2010 client.
Your phone is not ringing when receiving an incoming call.	Your phone is not set up to play sounds from Microsoft Lync 2010.	Do one of the following steps: <ul style="list-style-type: none"> • If you are trying to hear sounds from the speakerphone, make sure the handset is on-hook. • Make sure that the speaker volume is high enough to be audible. • Make sure that the phone is selected as the speaker and microphone device. For more information, refer to Configuring Microsoft Lync 2010 for the Polycom CX300 Desktop Phone on page 1-7. • Make sure that the speaker is not muted on your computer. • If you changed the default playback settings, you must restart Microsoft Lync 2010.

Access to Systems

Symptom	Problem	Corrective Action
There is no response from key presses.	The Polycom CX300 desktop phone is not in active state.	Do one of the following steps: <ul style="list-style-type: none"> Press the keys more slowly. Make a call to the phone to check for inbound call display and ringing as normal.
The display show "Sign in..." or "Please Upgrade" when the phone is already connected to your computer.	Your computer does not have Microsoft Lync 2010 installed or has a version of Microsoft Office Communicator 2007 that does not support the Polycom CX300 desktop phone.	Do one of the following steps: <ul style="list-style-type: none"> Make sure that the correct version of Microsoft Lync 2010 is installed on your computer. Make sure that you are signed in to Microsoft Lync 2010. Make sure that your network connection is active. <p>Note: If Microsoft Lync 2010 is not installed, you can use the Polycom CX300 desktop phone as an audio device only.</p>

Audio

Symptom	Problem	Corrective Action
There is no audio on the Polycom CX300 handset earpiece.	Your Microsoft Lync 2010 account may not be configured correctly.	Contact your system administrator to ensure your account is configured in Enterprise Voice mode.
There is no audio on the headset.	The headset is not properly connected or turned on. Volume may be set too low.	Ensure that the headset is properly connected. Ensure that the headset amplifier (if required for your headset) is turned on and/or the volume is correctly adjusted). Verify that the phone is logged in and registered with Microsoft Lync 2010.
	The headset is not one of the supported headsets.	Ensure that the headset is listed in Support Headsets for Polycom CX Phones, which is available at http://www.polycom.com/global/documents/support/technical/products/voice/CX200_700_Headset_Compatibility.pdf .

Symptom	Problem	Corrective Action
Pressing the Speakerphone key has no effect. The sound still comes out of the handset earpiece.	The Audio settings in your Microsoft Lync 2010 client are not correct.	Adjust the audio settings in Microsoft Lync 2010 to ensure that speaker audio is directed to your computer's speakers. For more information, refer to Configuring Microsoft Lync 2010 for the Polycom CX300 Desktop Phone on page 1-7.
The display shows an audio graphic when you are not using the phone as an audio device.	An open web page or an application that is running in the background may be streaming media to the phone or have the streaming interface selected.	Do one of the following steps: <ul style="list-style-type: none"> Ignore the audio graphic. Close the web page or shut down the application.

Microsoft Lync 2010

Symptom	Problem	Corrective Action
The Microsoft Lync 2010 client is not working properly.	There may be problems with the Microsoft Lync 2010 client software or with Microsoft Lync 2010.	Contact your system administrator to ensure your account is configured properly and that your Microsoft Lync 2010 client software and the Microsoft Lync 2010 software are properly installed and configured.

Safety Notices

Service Agreements

Please contact your Polycom Authorized Reseller for information about service agreements applicable to your product.

Governing Law

This Limited Warranty and Limitation of Liability shall be governed by the laws of the State of California, U.S.A., and by the laws of the United States, excluding their conflicts of laws principles. The United Nations Convention on Contracts for the International Sale of Goods is hereby excluded in its entirety from application to this Limited Warranty and Limitation of Liability.

All rights reserved under International and Pan-American Copyright Conventions. No part of the contents of this manual may be copied, reproduced, or transmitted in any form or by any means, or translated into another language or format, in whole or part, without written consent from Polycom, Inc. Do not remove (or allow anybody else to remove) any product identification, copyright or other notices.

Limitations of Liability

LIMITATION OF LIABILITY. TO THE FULL EXTENT ALLOWED BY LAW, POLYCOM EXCLUDES FOR ITSELF AND ITS SUPPLIERS ANY LIABILITY, WHETHER BASED IN CONTRACT OR TORT (INCLUDING NEGLIGENCE), FOR INCIDENTAL, CONSEQUENTIAL, INDIRECT, SPECIAL, OR PUNITIVE DAMAGES OF ANY KIND, OR FOR LOSS OF REVENUE OR PROFITS, LOSS OF BUSINESS, LOSS OF INFORMATION OR DATA, OR OTHER FINANCIAL LOSS ARISING OUT OF OR IN CONNECTION WITH THE SALE, INSTALLATION, MAINTENANCE, USE, PERFORMANCE, FAILURE, OR INTERRUPTION OF ITS PRODUCTS, EVEN IF POLYCOM OR ITS AUTHORIZED RESELLER HAS BEEN ADVISED OF THE POSSIBILITY OF SUCH DAMAGES, AND LIMITS ITS LIABILITY TO REPAIR, REPLACEMENT, OR REFUND OF THE PURCHASE PRICE PAID, AT POLYCOM'S OPTION. THIS DISCLAIMER OF LIABILITY FOR DAMAGES WILL NOT BE AFFECTED IF ANY REMEDY PROVIDED HEREIN SHALL FAIL OF ITS ESSENTIAL PURPOSE.

Polycom Limited Warranty and Limitation Liability

LIMITED WARRANTY. Polycom warrants to the end user (“Customer”) that this product is expected to be free from defects in workmanship and materials, under normal use and service, for one year from the date of purchase from Polycom or its authorized reseller.

Polycom’s sole obligation under this express warranty is at Polycom’s option and expense, to repair the defective product or part, deliver to Customer an equivalent product or part to replace the defective item, or if neither of the two foregoing options are reasonably available, Polycom may, on its sole discretion, refund to Customer the purchase price paid for the defective product. All products that are replaced will become the property of Polycom. Replacement products or parts may be new or reconditioned.

Polycom is expected to warrant any replaced or repaired product or part for ninety (90) days from shipment, or the remainder of the initial warranty period, whichever is longer. Products returned to Polycom must be sent prepaid and packaged appropriately for safe shipment, and it is recommended that they be insured or sent by a method that provides for tracking of the package. Responsibility for loss or damage does not transfer to Polycom until the returned item is received by Polycom. The repaired or replaced item will be shipped to Customer, at Polycom’s expense, not later than thirty (30) days after Polycom receives the defective product, and Polycom will retain risk of loss or damage until the item is delivered to Customer.

The product software comes with 90-day software warranty, providing for software updates (minor releases/bug fixes). To continue to receive support, purchasing a maintenance contract is the most economical solution.

Exclusions

Polycom will not be liable under this limited warranty if its testing and examination disclose that the alleged defect or malfunction in the product does not exist or results from:

- Failure to follow Polycom’s installation, operation, or maintenance instructions.
- Unauthorized product modification or alteration.
- Unauthorized use of common carrier communication services accessed through the product.
- Abuse, misuse, negligent acts or omissions of Customer and persons under Customer’s control; or
- Acts of third parties, acts of God, accident, fire, lightening, power surges or outages, or other hazards.

Warranty Exclusive

IF A POLYCOM PRODUCT DOES NOT OPERATE AS WARRANTED ABOVE, CUSTOMER’S SOLE REMEDY FOR BREACH OF THAT WARRANTY SHALL BE REPAIR, REPLACEMENT, OR REFUND OF THE PURCHASE PRICE PAID, AT POLYCOM’S OPTION. TO THE FULL EXTENT ALLOWED BY LAW, THE FOREGOING WARRANTIES AND REMEDIES ARE EXCLUSIVE AND ARE IN LIEU OF ALL OTHER WARRANTIES, TERMS, OR CONDITIONS, EXPRESS OR IMPLIED, EITHER IN FACT OR BY OPERATION OF LAW, STATUTORY OR OTHERWISE, INCLUDING WARRANTIES, TERMS, OR CONDITIONS OF MERCHANTABILITY, FITNESS FOR A PARTICULAR PURPOSE, SATISFACTORY QUALITY, CORRESPONDENCE WITH DESCRIPTION, AND NON-INFRINGEMENT, ALL OF WHICH ARE EXPRESSLY DISCLAIMED. POLYCOM NEITHER ASSUMES NOR AUTHORIZES ANY OTHER PERSON TO ASSUME FOR IT ANY OTHER LIABILITY IN CONNECTION WITH THE SALE, INSTALLATION, MAINTENANCE OR USE OF ITS PRODUCTS.

Safety and Compliance

Usage and Cleaning

- Use in accordance with these instructions.
- Do not use near any heat sources.
- Only use attachments/accessories specified by Polycom.
- Clean only with dry cloth.

Operating Environment

This device is rated as a commercial product for operation at +41°F (+5°C) to +95°F(+35°C).

WARNING Electrical Safety

Failure to properly set up, use, and care for the Polycom CX300 can increase the risk of damage to the Polycom CX300, or possible serious injury. To ensure personal safety, this product must be used with NRTL Listed (UL, CSA, ETL, etc.), and/or CE marked Information Technology equipment.

Warning: This equipment may become inoperable if electrical power fails or broadband internet access is interrupted.

Any changes or modifications not expressly approved by Polycom could void the user's authority to operate this device.

No serviceable parts included.



Disposal of Waste Electrical & Electronic Equipment in the European Union and Other Countries with Separate Collection Systems

This symbol on the product or its packaging means that this product must not be disposed of with your household waste. Instead, it is your responsibility to hand this over to an applicable collection point for the recycling of electrical and electronic equipment. This separate collection and recycling will help to conserve natural resources and prevent potential negative consequences for human health and the environment due to the possible presence of hazardous substances in electrical and electronic equipment, which could be caused by inappropriate disposal. For more information about where to drop off your electrical and

electronic waste, please contact your local city or municipality office, your household waste disposal service, or the shop where you purchased this product. Refer to http://ec.europa.eu/environment/waste/weee/index_en.htm for additional information on WEEE.

FCC Part 15 Class B

This equipment has been tested and found to comply with the limits for a Class B digital device, pursuant to part 15 of the FCC Rules. These limits are designed to provide reasonable protection against harmful interference in a residential installation. This equipment generates, uses and can radiate radio frequency energy and, if not installed and used in accordance with the instructions, may cause harmful interference to radio communications. However, there is no guarantee that interference will not occur in a particular installation. If this equipment does cause harmful interference to radio or television reception, which can be determined by turning the equipment off and on, the user is encouraged to try to correct the interference by one or more of the following measures:

- Reorient or relocate the receiving antenna
- Increase the separation between the equipment and receiver
- Connect the equipment into an outlet on a circuit different from that to which the receiver is connected
- Consult the dealer or an experienced radio/TV technician for help

Canada ICES-003

This Class [B] digital apparatus complies with Canadian ICES-003.

Cet appareil numérique de la classe [B] est conforme à la norme NMB-003 du Canada.

Safety and Compliance (Continued)

CE

This Polycom CX300 has been marked with the CE mark. This mark indicates compliance with EEC Directives 2004/108/EC and 2006/95/EEC. A full copy of the Declaration of Conformity can be obtained from Polycom Ltd, 270 Bath Road, Slough, Berkshire, SL1 4DX, UK.

Australia S004 Compliance

The user should be aware that, under certain operating conditions, the handset earpiece may retain small metallic objects. If this occurs, these objects should be removed before using the handset.

New Zealand, Telepermit, CX300 USB Telephone, PTC 220/10/002

PTC General Warning

The grant of a Telepermit for any item of terminal equipment indicates only that Telecom has accepted that the item complies with minimum conditions for connection to its network. It indicates no endorsement of the product by Telecom, nor does it provide any sort of warranty. Above all, it provides no assurance that any item will work correctly in all respects with another item of Telepermitted equipment of a different make or model, nor does it imply that any product is compatible with all of Telecom's network services.

The CODEC and Optimum Packet Size for transmission through the Public Switched Telephone Network (PSTN)

Because of the extensive delay already experienced when calling cellular and international networks, Telecom Access Standards recommends the use of 20mS or less packet length when passing packets through the PSTN. The use of G.711 codecs and 20mS or less packet length is critical to maintaining delay times which comply with PTC220 requirements (<50mS).

Echo cancellation

Echo cancellers are not normally required in the Telecom PSTN because geographic delays are acceptable where CPE return loss is maintained within Telepermit limits. However, those private networks making use of Voice over IP technology are required to provide echo cancellation for all voice calls. The combined effect of audio / VoIP conversion delay and IP routing delay can cause the echo cancellation time of 64 mS to be required.