



# Grandstream Networks, Inc.

## GXV3601\_HD High Definition IP Camera



## TABLE OF CONTENTS

### GXV3601\_HD User Manual

<b>WELCOME.....</b>	<b>4</b>
SAFETY COMPLIANCES.....	5
WARRANTY.....	7
<b>CONNECT YOUR GXV3601_HD .....</b>	<b>8</b>
EQUIPMENT PACKAGE CONTENTS.....	8
CONNECTING THE GXV3601_HD .....	8
<b>PRODUCT OVERVIEW .....</b>	<b>9</b>
GXV3601_HD CAMERA .....	10
GXV3601_HD SPECIFICATIONS .....	11
GXV3601_HD LENS SPECIFICATIONS.....	12
<b>INSTALLATION GUIDE .....</b>	<b>13</b>
MINIMUM RECOMMENDED COMPUTER SYSTEM REQUIREMENT.....	13
CONFIGURE THE GXV3601_HD VIA WEB BROWSER.....	13
GXV3601_HD HOME WEB PAGE .....	18
GXV3601_HD CONFIGURATION & LANGUAGE PAGE .....	19
<b>BASIC SETTINGS EXPLANATION .....</b>	<b>20</b>
SYSTEM SETTINGS PAGE .....	20
VIDEO & AUDIO SETTING PAGE .....	22
NETWORKING SETTING PAGE .....	25
WI-FI SETTINGS PAGE .....	27
DDNS SETTINGS PAGE .....	29
SIP SETTING PAGE.....	30
STATUS PAGE.....	33
<b>ADVANCED SETTINGS EXPLANATION.....</b>	<b>34</b>
USER MANAGEMENT PAGE.....	34
MAINTENANCE PAGE.....	35
SMTP SETTING PAGE (EMAIL ALARM).....	36
FTP SETTINGS PAGE (UPLOAD ALARM).....	38
PTZ CONTROL SETTINGS PAGE .....	39
ALARM SERVER SETTINGS PAGE (UPLOAD ALARM TO SUPPORTED VMS OR HTTP SERVER) .....	41
ALARM EVENT .....	42
MOTION DETECTION CONFIGURATION PAGE (SET ALARM) .....	47
SYSLOG SETTINGS PAGE (TROUBLESHOOTING) .....	49
RECORD SETTINGS PAGE (LOCAL DVR RECORD SCHEDULE) .....	50
LIVE STORAGE SETTING PAGE (SD CARD FILE MANAGEMENT).....	51
SOFTWARE UPGRADE .....	53
SOFTWARE UPGRADE VIA TFTP, HTTP OR HTTPS.....	53
INSTRUCTIONS FOR LOCAL FIRMWARE UPGRADE USING TFTP SERVER: .....	54
CONFIGURATION FILE DOWNLOAD .....	54
<b>RESTORE FACTORY DEFAULT SETTING.....</b>	<b>55</b>
RESET FROM WEB INTERFACE.....	55
<b>IP SURVEILLANCE FAQ .....</b>	<b>56</b>

**TABLE OF FIGURES**

**GXV3601\_HD USER MANUAL**

FIGURE 1: HOME PAGE OF GXV3601_HD .....	18
FIGURE 2: WEB LANGUAGE SWITCH .....	19
FIGURE 3: SYSTEM SETTINGS PAGE.....	20
FIGURE 4-1: VIDEO & AUDIO SETTINGS PAGE.....	22
FIGURE 4-2: VIDEO & AUDIO SETTINGS PAGE.....	24
FIGURE 5: NETWORKING SETTING PAGE.....	25
FIGURE 6-1: WI-FI NETWORKING SETTING PAGE.....	27
FIGURE 6-2: WI-FI NETWORKING SETTING PAGE.....	28
FIGURE 7: DDNS SETTING PAGE.....	29
FIGURE 8-1: SIP SETTING PAGE.....	30
FIGURE 8-2: SIP SETTING PAGE.....	31
FIGURE 9: STATUS PAGE.....	33
FIGURE 10: USER MANAGEMENT PAGE .....	34
FIGURE 11: MAINTENANCE PAGE .....	35
FIGURE 12: SMTP SETTING PAGE .....	36
FIGURE 13: FTP SETTING PAGE.....	38
FIGURE 14: FTP SETTING PAGE.....	39
FIGURE 15: ALARM HTTP SERVER SETTING PAGE .....	41
FIGURE 16: ALARM EVENT SETTING PAGE .....	42
FIGURE 17-1: MOTION DETECTION CONFIGURATION PAGE.....	47
FIGURE 17-2: MOTION DETECTION SCHEDULE CONFIGURATION PAGE .....	48
FIGURE 18: SYSLOG SETTING PAGE.....	49
FIGURE 19: RECORD TIME SCHEDULE SETTING PAGE .....	50
FIGURE 20: LIVE STORAGE – SD CARD FILE MANAGEMENT PAGE.....	51
FIGURE 21: FIRMWARE UPGRADE AND PROVISIONING .....	53
FIGURE 22: FACTORY RESET FROM WEB INTERFACE .....	55

**TABLE OF TABLES**

**GXV3601\_HD USER MANUAL**

TABLE 1: GXV3601_HD TECHNICAL SPECIFICATIONS .....	11
TABLE 2: GXV3601_HD LENS SPECIFICATIONS.....	12



## WELCOME

Thank you for purchasing Grandstream's GXV3601\_HD High Definition IP Camera,

The GXV3601\_HD is a next generation IP camera for remote monitoring and surveillance over your LAN or internet. The GXV3601\_HD combines best in class IP video technology and SIP protocols for a robust IP surveillance solution. It features innovative H.264 real-time video compression with excellent image clarity (720p) and color fidelity, industry leading SIP/VoIP for 2-way audio and video streaming to smartphones and video phones, integrated PoE, and advanced security protection using strong encryption.

The GXV3601\_HD ensures ease of use, integration and deployment with a multilingual graphical user interface. It can be quickly installed and connected to your network and accessed from anywhere over the internet.

The GXV3601\_HD can be managed with GSurf\_Pro, Grandstream's intuitive FREE VMS (video management systems) software that controls up to 36 cameras (\*) simultaneously. It is fully compliant with ONVIF standard and offers flexible HTTP API and an SDK for advanced integration.

The GXV3601\_HD is a powerful solution for small to medium sized offices, homes and storage facilities looking to safeguard their valuables.

This manual will help you to learn how to operate and manage your GXV3601\_HD IP camera and make the best use of it.

## Safety Compliances

These instructions are intended to assist users with the operation of the GXV3601\_HD and to instruct on how to avoid dangerous situations or damage to the device.

**Warning:** Serious injury or death may be caused if any of the warnings below are neglected.

**Caution:** Injury or damage to the equipment may occur if any of the following caution messages are neglected.



**Warning:** Follow these safeguards to prevent serious injury or death.



**Caution:** Follow these precautions to prevent potential injury or material damage.



**Warning:**

Input voltage should meet both the SELV (Safety Extra Low Voltage) and the Limited Power Source with DC 12V according to the IEC60950-1 standard. Please refer to the technical specifications for more details. Do not use a third-party power adapter or power cord. When the device installed on the wall or ceiling, make sure that it is firmly attached.



**Notice:**

Make sure that the power supply voltage is correct before using the camera.

- Do not drop the device or expose it to physical shock.
- Do not expose the device to temperatures outside the range of 0 °C to 45°C when the device is in operation.
- Do not expose the device to damp/wet conditions or high electromagnetism radiation. To avoid heat accumulation, make sure that your operating environment has proper ventilation.
- Do not attempt to open, disassemble, or modify the device

A few parts (e.g. electrolytic capacitor) of the equipment shall be replaced regularly according to their average lifetime. The average lifetime varies from the differences between operating environments and usage history. Regular maintenance checks are recommended for all users.

Please contact your dealer for more details.

## Warranty

If the GXV3601\_HD was purchased from a reseller, please contact the company where the device was purchased for replacement, repair or refund.

If the device was purchased directly from Grandstream, please contact our Technical Support Team for a RMA (Return Materials Authorization) number before the product is returned.

Grandstream reserves the right to remedy warranty policy without prior notification.

### **Caution:**

*Changes or modifications to this product not expressly approved by Grandstream, or operation of this product in any way other than as detailed by this User Manual, could void your manufacturer warranty. Please do not use a different power adaptor with the GXV3601\_HD as it may cause damage to the products and void the manufacturer warranty.*

- This document is subject to change without notice. The latest electronic version of this user manual is available for download at:  
[http://www.grandstream.com/products/surveillance/GXV3610hd/documents/GXV3601\\_HD\\_usermanual\\_english.pdf](http://www.grandstream.com/products/surveillance/GXV3610hd/documents/GXV3601_HD_usermanual_english.pdf)

*Reproduction or transmittal of the entire or any part, in any form or by any means, electronic or print, for any purpose is not permitted without the express written permission of Grandstream Networks, Inc.*

## CONNECT YOUR GXV3601\_HD

### Equipment Package Contents

The GXV3601\_HD package contains:

- GXV3601\_HD IP Camera
- 12V DC Universal Power Adaptor
- 6-pin terminal block connector: 6-pin connector block for connecting external devices, such as infrared detector, smoke detector and etc., to Alarm IN, Alarm OUT and RS485 pins.
- Quick Installation Guide

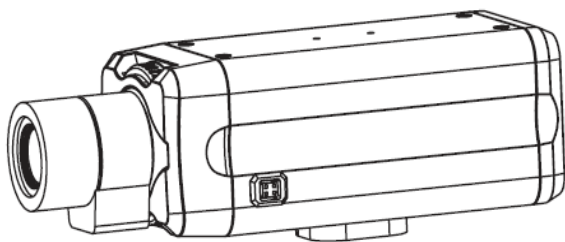

GXV3601

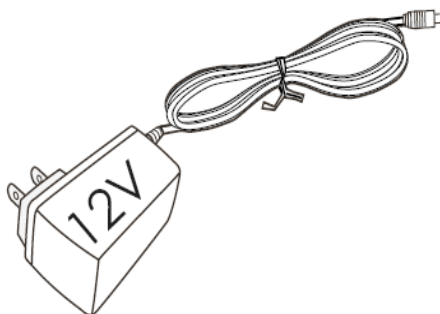

Power Adapter

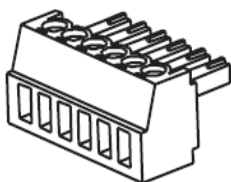

6-pin Terminal Block Connector

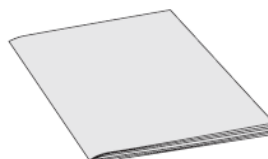

Quick Installation Guide



## Connecting the GXV3601\_HD

### Using the Power Adapter as power supply

- Connect the RJ-45 Ethernet cable to the NETWORK port of the GXV3601\_HD
- Connect the other end of the RJ-45 cable to your network (switch or router or PC)
- Connect the power supply to the DC 12V power jack on the back of the GXV3601\_HD

### Using PoE as power supply

- Connect the RJ-45 Ethernet cable to the NETWORK port of GXV3601\_HD
- Connect the other end of the RJ-45 cable to your PoE switch.

## GXV3601\_HD Sample Connection Diagram

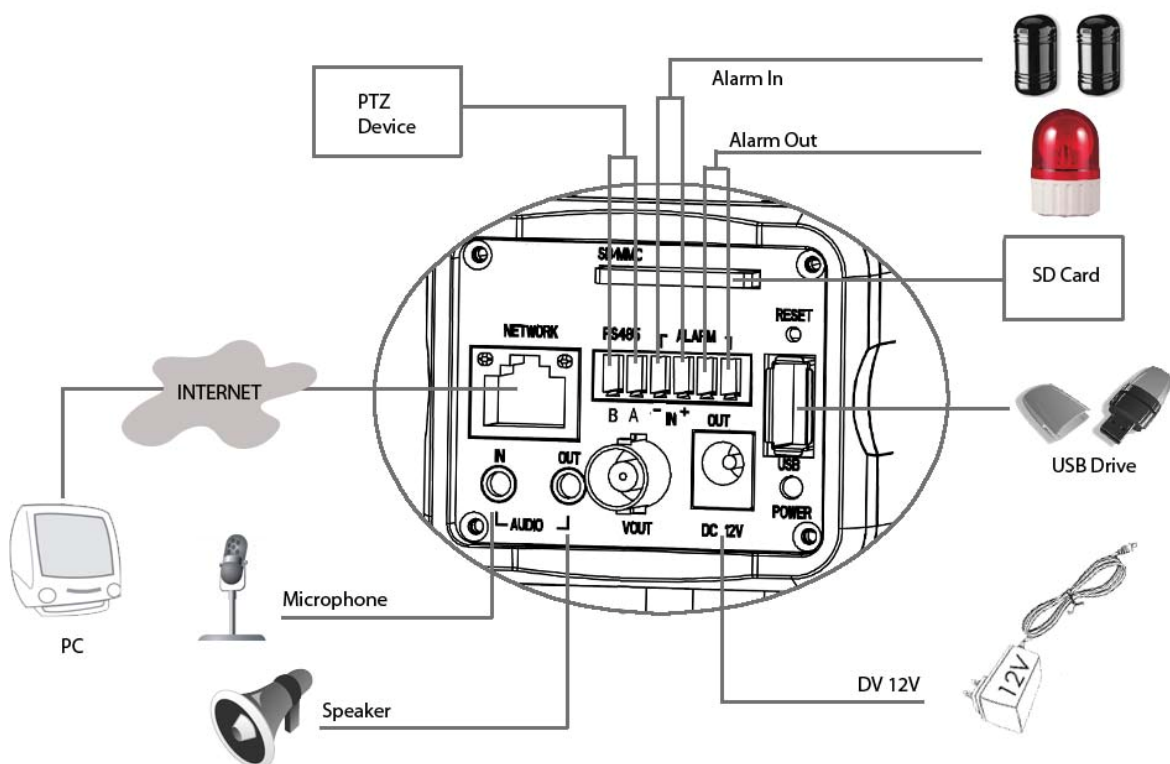

## PRODUCT OVERVIEW

### GXV3601\_HD Camera



**Microphone** Built-in Front Microphone  
**Lens** 1/3"CS Mount Vari-focal Lens

### GXV3601\_HD Back Panel

#### Indicators and Connectors on Back Panel

**NETWORK** – 10/100 LAN port for connecting to Ethernet. The indicator will be steady for connection and flashing for network activity.

**AUDIO IN** – 3.5mm port for audio input devices (microphone, pickup and etc.).

**AUDIO OUT** – 3.5mm port for audio output devices (amplified speakers, etc.).

**DC 12V** – 12V DC power jack; UL Certified.

**SD/MMC** – SD card slot.

**RESET** – Press the Reset button for 10 seconds to perform a factory reset.

**PINs** – RS-485 PTZ connector, Alarm In connector, and Alarm out connector.

**USB** – USB connector for USB flash drives.



## GXV3601\_HD Specifications

Table 1: GXV3601\_HD Technical Specifications

Model	GXV3601_HD
<b>Video Compression</b>	H.264, MJPEG
<b>Image Sensor Resolution</b>	Aptina 2 Megapixel CMOS Sensor, 1600H x 1200V, Low Noise Levers and Low Light Sensitivity
<b>Lens Type (Vari-focal)</b>	1/3", 2.8 ~ 12 mm, F1.4, Manual Iris, CS Mount (changeable)
<b>Day &amp; Night</b>	No
<b>Minimum Illumination</b>	0.5 Lux
<b>Sensibility</b>	1.0V / Lux-sec (550nm)
<b>Maximum Video Resolution</b>	1600 x 1200
<b>Pixel Dynamic Range</b>	71dB, with Max. SNR 41dB
<b>Max. Frame Rate In Max. Resolution</b>	1600x1200 @15FPS; 1280x960 @23FPS; 1280x720 @30FPS; 1024x768 @30FPS; 800x592 @30FPS; 800x480 @30FPS; 640x480 @30FPS; e-PTZ, etc.
<b>Video Bit Rate</b>	16Kbps ~ 8Mbps adjustable, two video streaming
<b>Video Output</b>	N/A
<b>Audio Input</b>	3.5mm LINE-IN, built-in Microphone
<b>Audio Output</b>	3.5mm, LINE-OUT
<b>Alarm Input</b>	Yes – 1, Normal Open
<b>Alarm Output</b>	Yes -1, 125VAC/0.5A; 30VAC/2A
<b>Audio Compression</b>	G.711 (u/a), G.726
<b>Serial Port</b>	RS-485
<b>Iris Control</b>	Manual Iris
<b>Embedded Analytics</b>	Motion Detection (upto 16 target areas)
<b>Pre/Post Alarm Buffer</b>	24MB
<b>Snapshots</b>	Triggered upon events, send via email/FTP
<b>Multi-Streaming Supported</b>	Yes (Primary stream and 2 <sup>nd</sup> stream)
<b>Security</b>	Video Watermark (OSD), HTTPS, Password
<b>Network Port</b>	10M/100M auto-sensing, RJ-45
<b>Network Protocol</b>	TCP/UDP/IP, RTP/RTCP, RTSP, DHCP, PPPoE, DDNS, HTTP, HTTPS
<b>Power over Ethernet (PoE)</b>	Yes, IEEE802.af Class 3
<b>Peripheral Port</b>	SDHC2.0; USB2.0
<b>SIP/VoIP Support</b>	Yes
<b>Dimensions (L x W x H)</b>	155mm x 68mm x 64mm
<b>Weight</b>	0.6 kg
<b>Temperature / Humidity</b>	0°C ~ 45°C (32°F ~ 113°F) Humidity 10 ~ 90% RH (non-condensing)
<b>Power Adapter</b>	Output: 12VDC/1A; Input: 100 ~ 240VAC, 50 ~ 60Hz
<b>Compliance</b>	FCC Part15, Subpart B Class B; EN55022 Class B, EN61000-3-2, EN61000-3-3, EN55024, EN60950-1, C-tick AS/NZS CISPR22, CISPR24

## GXV3601\_HD Lens Specifications

Table 2: GXV3601\_HD Lens Specifications

Parameters	GXV3601-HD
Lens Mount	CS
Lens Format	1/3" Mega
Focal Length	Variable focus, 2.8 to 12 mm
Back Focal Length	8.28~13.38mm
Aperture (D/f')	1.4~360
Effective Aperture	16.4mm (Front) / 9mm (Rear)
Minimum Object Distance	0.1 m
Horizontal View Angle	100° ~43° / 78° ~34° / 57° ~25.5°
IRIS	Manual Iris
Size (Diameter x Length 1 x Length 2)	φ33 X (43.7) mm
Weight	101g
Operation	Focus (w/lock) Zoom (w/lock)

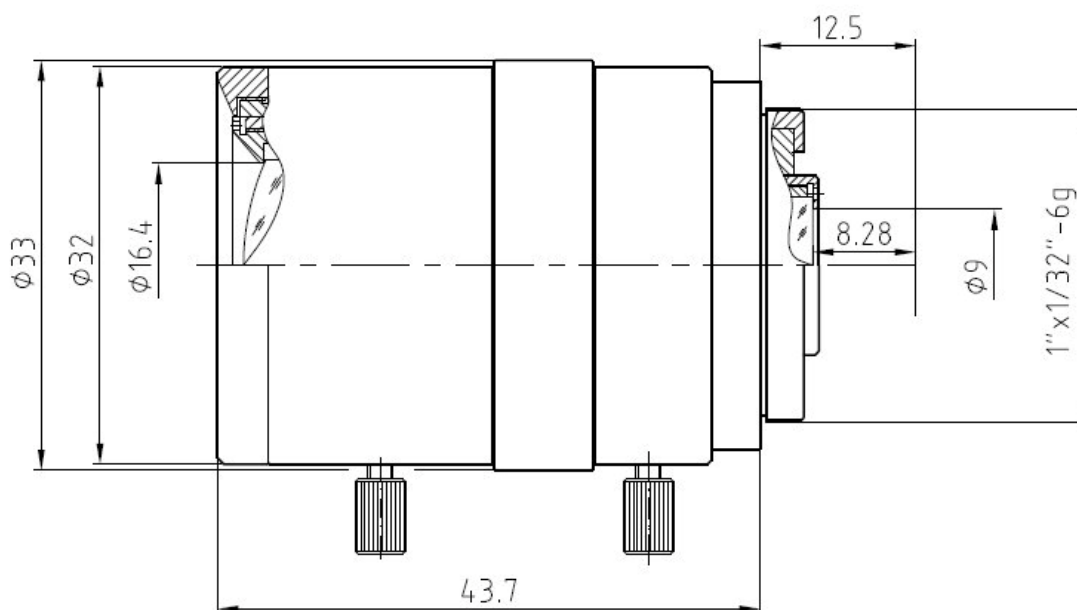

## INSTALLATION GUIDE

### Minimum Recommended Computer System Requirement

To install GXV3601\_HD, you have to have a computer, PC recommend.

The minimum recommended PC system requirement listed below:

- Windows XP, Windows Vista, Windows 7 and Windows 8
- CPU: Intel Pentium 4 or higher, 2 GHz
- RAM: 1 GB (4 GB recommended for larger systems)
- Support for DirectX 8.0 and above.

### Configure the GXV3601\_HD via Web Browser

The GXV3601\_HD has embedded Web server to respond to HTTP GET/POST requests. Embedded HTML pages allow user to configure the IP camera through Microsoft Internet Explorer (7.0 or above), Firefox and Chrome (plug-in from Grandstream required).

- Download Plug-in from Grandstream website:  
[http://www.grandstream.com/products/tools/surveillance/webcontrl\\_plugin.zip](http://www.grandstream.com/products/tools/surveillance/webcontrl_plugin.zip)

#### **NOTE:**

- *Apple Safari is NOT yet supported and status pending.*
- *Please temporarily disable Antivirus or Internet Security Software when download and install the Grandstream Plug-in Software.*

## Connect the Camera to network with DHCP server (Recommended)

The GXV3601\_HD by default enabled as DHCP client, it will automatically get IP address from the network with DHCP server running. User can know the IP address assigned to the camera from DHCP server log or using “SearchTool” from Grandstream GSurf\_Pro free VMS software.

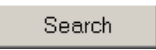
1. Download and install the GSurf\_Pro software from Grandstream website:  
[http://www.grandstream.com/products/tools/surveillance/gsurf\\_pro.zip](http://www.grandstream.com/products/tools/surveillance/gsurf_pro.zip)
2. Run the “Search Tool” in the pull down Menu of “Manage Tool” tag
3. Click on  button to begin device detection
4. The detected devices will appear in the Output field like below

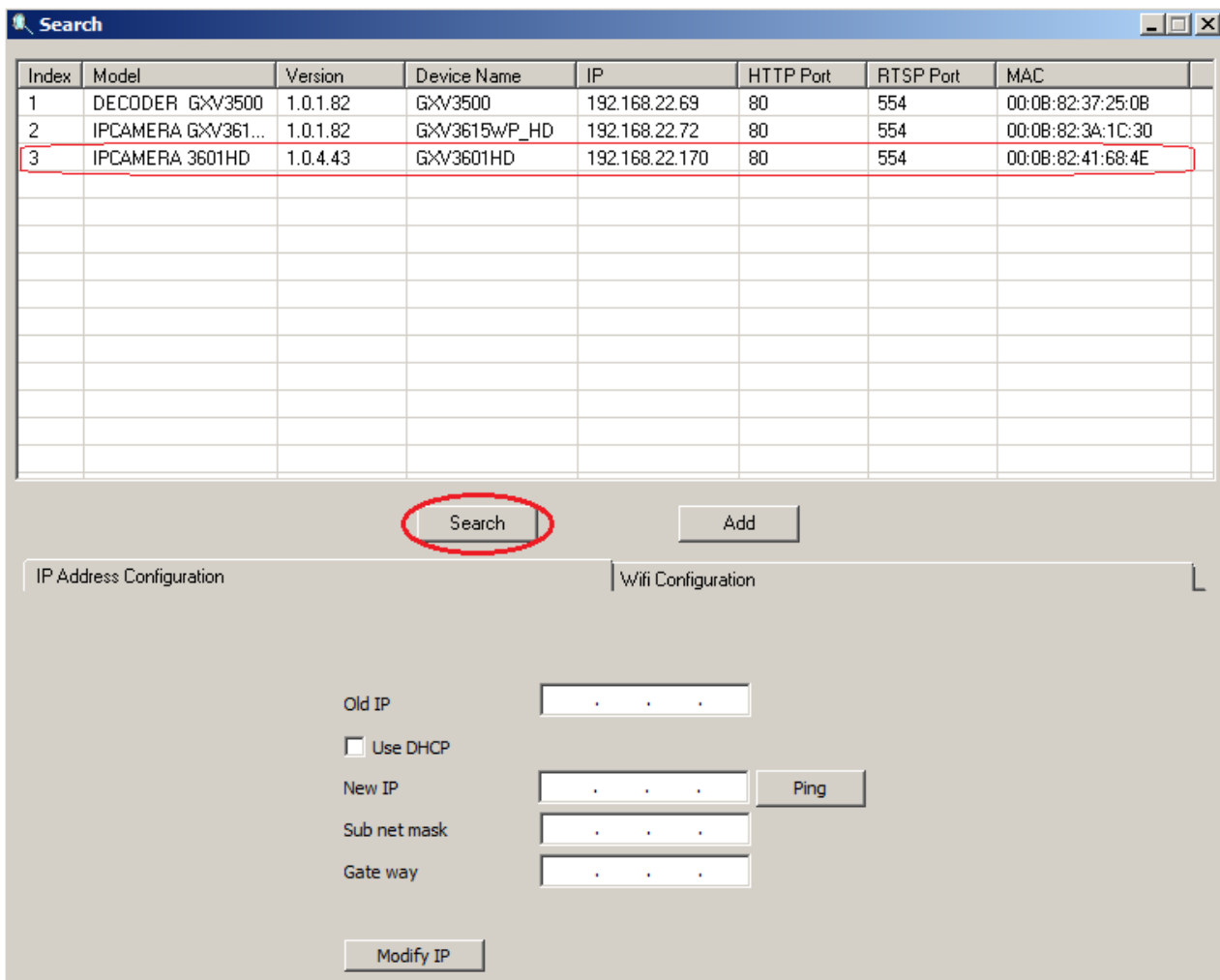

The screenshot shows the 'Search' window with a table of detected devices. The third row is highlighted with a red border, indicating the detected GXV3601HD camera.

Index	Model	Version	Device Name	IP	HTTP Port	RTSP Port	MAC
1	DECODER GXV3500	1.0.1.82	GXV3500	192.168.22.69	80	554	00:0B:82:37:25:0B
2	IPCAMERA GXV361...	1.0.1.82	GXV3615wP_HD	192.168.22.72	80	554	00:0B:82:3A:1C:30
3	IPCAMERA 3601HD	1.0.4.43	GXV3601HD	192.168.22.170	80	554	00:0B:82:41:68:4E

Below the table, there are buttons for 'Search' (circled in red) and 'Add'. The 'IP Address Configuration' section includes fields for 'Old IP', 'New IP', 'Sub net mask', and 'Gate way', along with a 'Use DHCP' checkbox and a 'Ping' button. A 'Modify IP' button is located at the bottom.

5. Double click the column of the detected camera, the browser will automatically open and link to the device IP and the web configuration page.
6. The browser will ask for plug-in or ActiveX if not installed, otherwise it will get to Home page and start to show the video captured by the camera (by default the camera enabled anonymous access)
7. Click “Configuration”, the browser will ask credentials to authorize configuration.
8. Enter the administrator user name and password to access the Web Configuration Interface, the default user name and password are both set to *admin*.
9. In step 6, browser will indicate that “This website wants to install the following add-on: GSViewerX.cab from Grandstream Networks Inc.”, allow the installation.
10. The plug-in can be download here:  
[http://www.grandstream.com/products/tools/surveillance/webcontrl\\_plugin.zip](http://www.grandstream.com/products/tools/surveillance/webcontrl_plugin.zip)

**NOTE:**

- *Please temporarily disable Antivirus or Internet Security Software and close all browsers when download and install the Grandstream Plug-in Software.*

## Connect to the Camera using Static IP

If no DHCP server in the network, or the camera does not get IP from DHCP server, user can connect the camera to a computer directly, using static IP to configure the camera.

The default IP, if no DHCP server; or DHCP offer time out (3 minutes), is **192.168.1.168**

1. Connect the computer RJ-45 via an Ethernet cable directly to the IP camera GXV3601\_HD.
2. Configure the computer using Static IP: 192.168.1.XXX (1<XXX<255, but NOT 168) and configure the “Subnet mask” to “255.255.255.0”. Leave the “Default Gateway” to “Blank” like below:

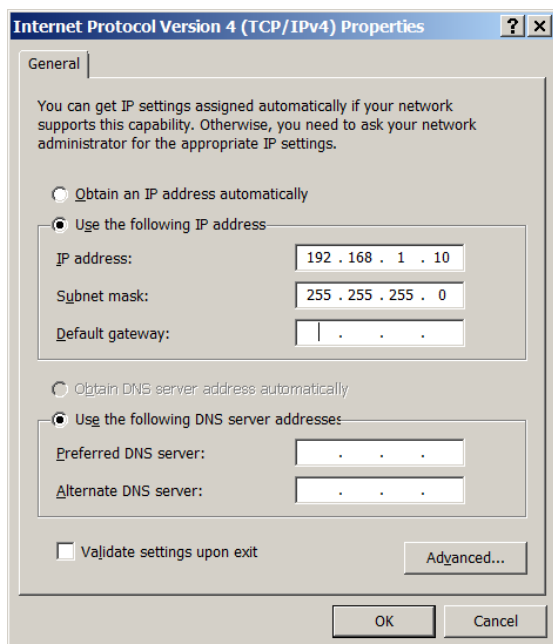

3. Power on the GXV3601\_HD.
4. Start the browser when the network connection is up.
5. Enter 192.168.1.168 in the address bar of the browser.
6. The browser will ask for plug-in or ActiveX if not installed, otherwise it will get to Home page and start to show the video captured by the camera (by default the camera enabled anonymous access)





7. Click “Configuration”, the browser will ask credentials to authorize configuration.
8. Enter the administrator user name and password to access the Web Configuration Interface, the default user name and password are both set to *admin*.
9. The plug-in can be downloaded from here:  
[http://www.grandstream.com/products/tools/surveillance/webcontrl\\_plugin.zip](http://www.grandstream.com/products/tools/surveillance/webcontrl_plugin.zip)

**NOTE:**

- *Please temporarily disable Antivirus or Internet Security Software and close all browsers when download and install the Grandstream Plug-in Software.*

## GXV3601\_HD Home Web Page

The Home Page of GXV3601\_HD shown as Figure 1:

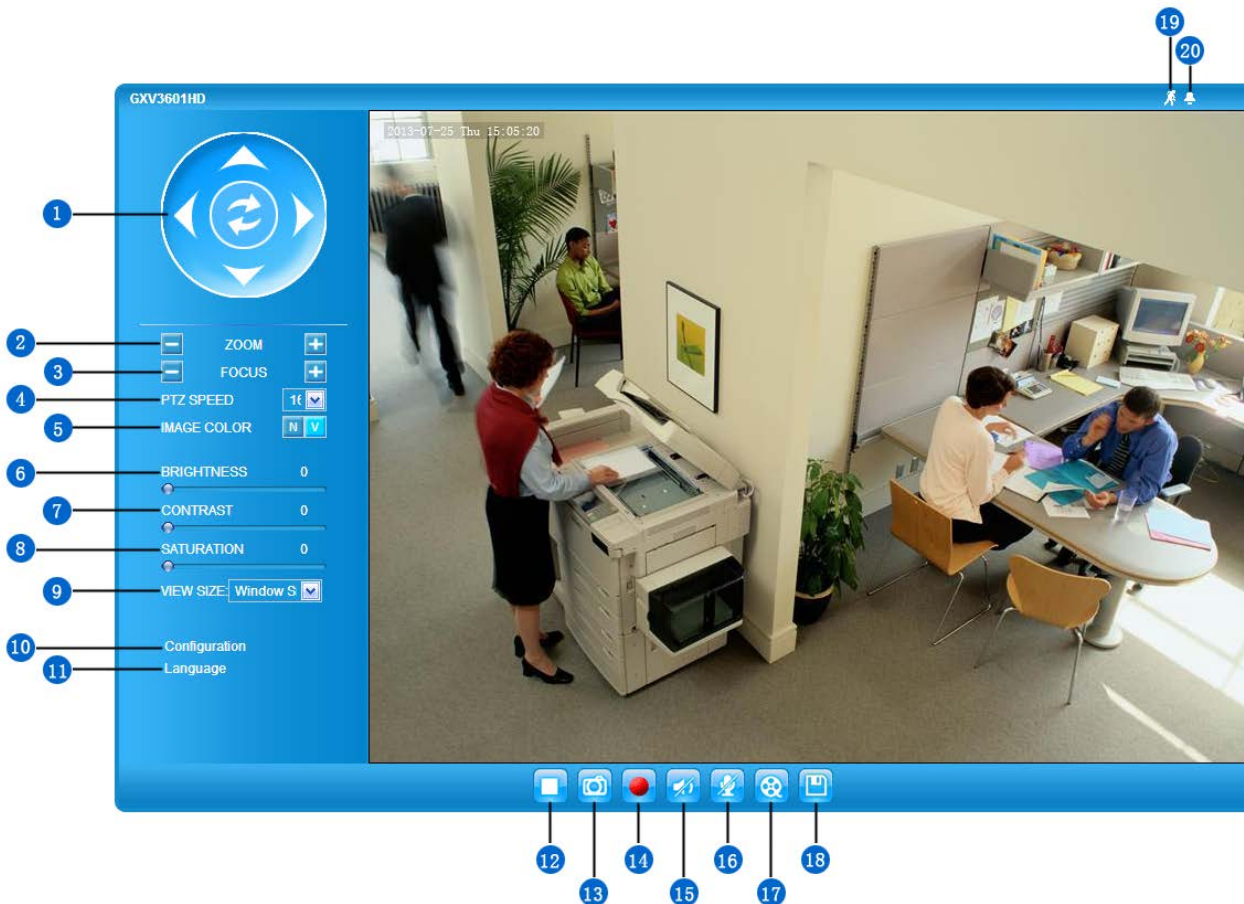

**Figure 1: Home Page of GXV3601\_HD**

- |  |   |
|--|---|
| <ol style="list-style-type: none"> <li>1. <b>Control Console:</b></li> <li>2. <b>ZOOM:</b></li> <li>3. <b>FOCUS:</b></li> <li>4. <b>PTZ SPEE:</b></li> <li>5. <b>IMAGE COLOR: N/V</b></li> <li>6. <b>BRIGHTNESS:</b></li> <li>7. <b>CONTRAST:</b></li> <li>8. <b>SATURATION:</b></li> <li>9. <b>VIEW SIZE:</b></li> <li>10. <b>Configuration:</b></li> </ol> | <p>PTZ Console controller for ePTZ function.</p> <p>Zoom in or Zoom out during ePTZ operation.</p> <p>Adjust the focus of image (Not Applicable).</p> <p>Adjust the rotate speed of the control console (Not Applicable);</p> <p>Click to switch between “N” (Normal) or “V” (Vivid) color by set default parameter of “BRIGHTNESS, CONTRAST, etc.</p> <p>Adjust the image or video brightness.</p> <p>Adjust the image or video contrast.</p> <p>Adjust the image or video saturation.</p> <p>Adjust the size of image or video to real size or fit GUI window</p> <p>Click to enter “Configuration Page” to configure the parameters of GXV3610_HD (administration privilege required).</p> |
|--|---|

- |  |   |
|--|---|
| <b>11. Language:</b>                         | Click to switch webpage language.<br>(Current support: Chinese, English and Russian)  |
| <b>12. Play/Stop:</b>                        | Start/Stop playing the video stream at embedded webpage.  |
| <b>13. Snapshot Capture:</b>                 | Click to take a snapshot of current video frame displayed.<br>Default directory: C:\Capture   |
| <b>14. Record:</b>                           | Click to Start/Stop record of current video stream into a file.<br>Default directory: C:\Record   |
| <b>15. Sound On/Off:</b>                     | Toggle to listen/stop the sound from camera microphone  |
| <b>16. Talk:</b>                             | Toggle to talk to camera speaker if provided (PC microphone and related speaker hardware required)  |
| <b>17. Playback:</b>                         | Click to playback the recorded video file.  |
| <b>18. Local Configuration:</b>              | Click to configure file path of snapshot and recorded video files.<br>Also adjust the live video delay or smoothness performance.                                     |
| <b>19. Motion Detection Alarm Indicator:</b> | If motion detection alarm triggered, the indicator will flash in <b>red</b> (if configured). Click the icon to turn off the alarm indication.                         |
| <b>20. DI Alarm:</b>                         | If external 3 <sup>rd</sup> party sensor DI alarm triggered, the indicator will flash in <b>red</b> (if configured). Click the icon to turn off the alarm indication. |

## GXV3601\_HD Configuration & Language Page

- When click the “Configuration” tab, web page will link to page to configure the related parameters of the GXV3601\_HD.
- There are two big categories of settings: Basic Settings and Advanced Settings. Details will be illustrated in the later Chapter.
- When click the “Language” tab, supported languages will be displayed in Figure 2. Click to select the related webpage display language.

**Figure 2: Web Language Switch**



- Currently firmware only support: English (default), Simplified Chinese and Russian.

## BASIC SETTINGS EXPLANATION

### System Settings Page

This page allow user to configure the system settings of GXV3601\_HD.

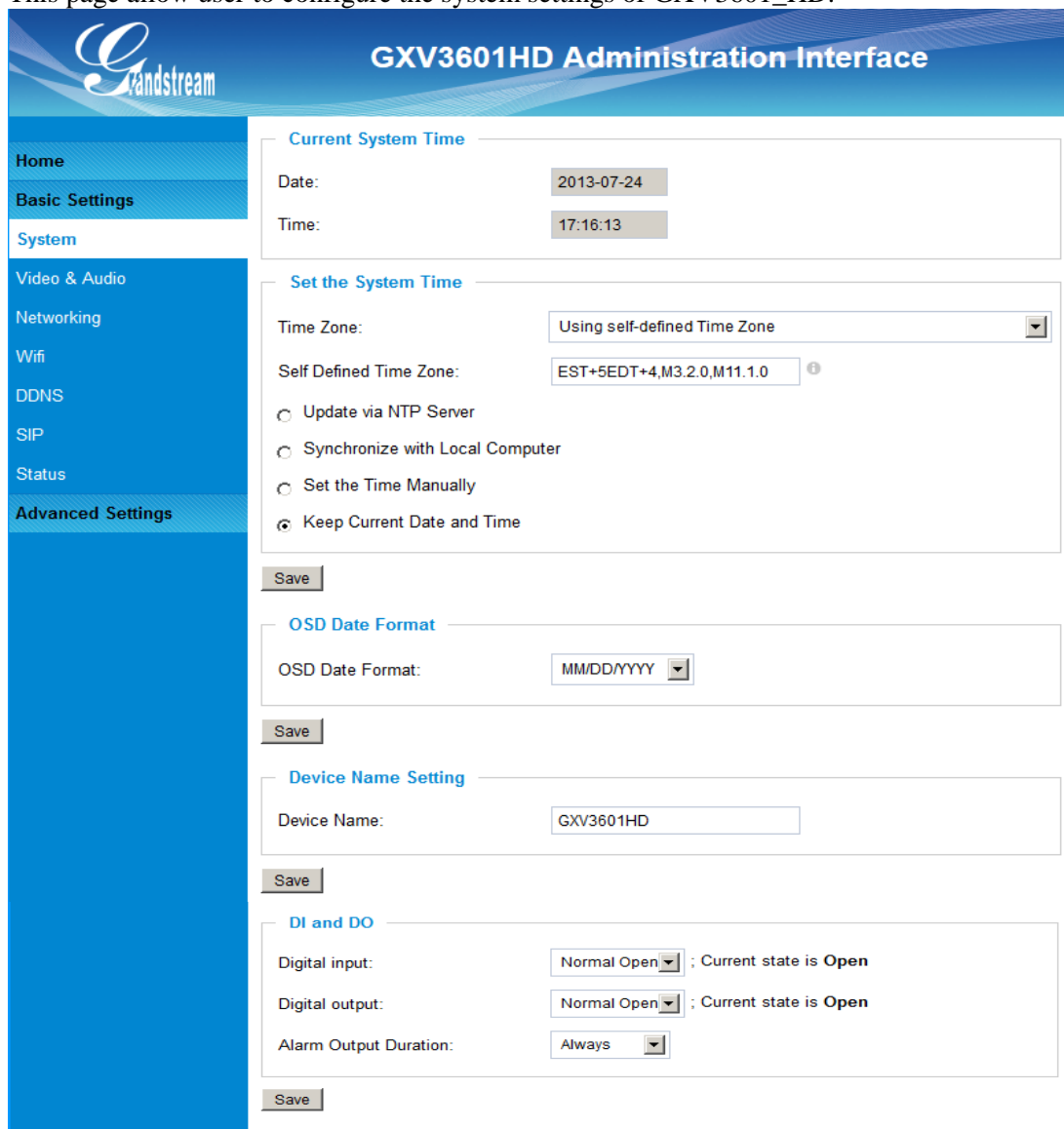

The screenshot shows the 'GXV3601HD Administration Interface' with a left-hand navigation menu. The 'System' settings section is active, displaying several configuration panels:

- Current System Time:** Date: 2013-07-24, Time: 17:16:13.
- Set the System Time:** Time Zone: Using self-defined Time Zone; Self Defined Time Zone: EST+5EDT+4,M3.2.0,M11.1.0; Radio buttons for Update via NTP Server, Synchronize with Local Computer, Set the Time Manually, and Keep Current Date and Time (selected).
- OSD Date Format:** OSD Date Format: MM/DD/YYYY.
- Device Name Setting:** Device Name: GXV3601HD.
- DI and DO:** Digital input: Normal Open (Current state is Open); Digital output: Normal Open (Current state is Open); Alarm Output Duration: Always.

Each configuration panel includes a 'Save' button.

**Figure 3: System Settings Page**

- **Current System Time:** Display time current system is running at
- **Set the System Time:** Configure the time system is running.
  - Time Zone: Select from pull down menu the time zone unit located
  - Self-Defined Time Zone: Use the self-defined time zone for automatic daylight saving time adjustment. Format please refer to the “help over mouse”
  - Update via NTP Server: Synchronize time using NTP protocol with a Time Server over the Internet cloud (\*)
  - Synchronize with Local Computer: Synchronize time with local computer
  - Set the Time Manually: Manually input the time
  - Keep Current D/T: Select to use camera current displayed time
- **OSD Date Format:** Pull down to select date format displayed on video screen
- **Device Name:** The name of device which will be shown in the result of “Search Tool” of GSurf\_Pro VMS program.
- **DI and DO:**
  - Digital Input: manual Set digital input initial state, following 3<sup>rd</sup> party sensor
  - Digital Output: manual Set digital output initial state, following 3<sup>rd</sup> party device
  - Alarm Output Duration: How long the alarm action will last before restore to idle again

**NOTE:**

(\*) If select this option, a valid DNS server must be preconfigured under

**Basic Settings → Networking**

➤  button has to be clicked to save all the changes made to the device.

## Video & Audio Setting Page

This page allows user to configure the video and audio related settings.



The screenshot shows the 'GXV3601HD Administration Interface' with a left-hand navigation menu. The 'Video & Audio' section is selected. The main content area is divided into two sections: 'On Screen Display(OSD)' and 'Video Settings'.

**On Screen Display(OSD) Settings:**

- OSD Text:
- OSD Position:
- OSD Transparency:
- OSD Color:
- Display Time:
- Display Text:

**Video Settings - Primary Stream Settings:**

- Preferred Video Codec:
- Resolution:
- Bit Rate:  kbps
- Maximum Frame Rate:  fps
- Bit Rate Control:  CBR  VBR
- I-frame Interval:  Frame(1-100)

A 'Save' button is located below the OSD settings section.

**Figure 4-1: Video & Audio Settings Page**

- **On Screen Display (OSD):** Display time stamp and text on the video screen.
  - OSD Text: Inputted text (to identify the camera) shown on the screen.
  - OSD Position: Show the OSD in either top or bottom position on screen.
  - OSD Transparency: Percentage of OSD text transparency in displayed video.
  - OSD Color: Color of the text used in the OSD.
  - Display Time: When checked, time stamp will display on video screen
  - Display Text: When checked, inputted text will display on video screen.

- **Audio Settings:**
  - Preferred Audio Codec: Pull down to select audio codec used: PCMU/A, G.726.
  - Audio Compression: Pull down to choose: 16, 24, 32, 40 kbps compression
  - Microphone Volume: Slide to adjust microphone gain from 1 to 10 (max.)
  - Speaker Volume: Slide to adjust speaker output gain from 1 to 10 (max.)
  - Line In: Pull down to choose Internal or External Microphone.
  
- **Power Frequency:** Select correct local power frequency (50Hz for Europe or 60Hz for US) to avoid video flicking effect under fluorescence light condition.
  
- **Flip Setting:** Check to flip video 180° vertically in horizontal axis.
  
- **Video Settings**
  - Primary Stream Settings:**
    - Preferred Video Codec: MJPEG and H.264 supported, H.264 recommended.
    - Resolution: The video resolution in pixels used in video of camera
    - Bit Rate: video bit rate used
    - Maximum Frame Rate: Maximum frame rate used. More data if big frame rate used
    - Bit Rate Control: Constantly bit rate, or variable bit rate
    - Image Quality: Image quality used when Variable Bit Rate used
    - I-frame Interval: I-frame interval
  
  - Secondary Stream Settings:** Pull down to select, same as Primary steam.

**NOTE:**

- *H.264 suggested if camera needs to be viewed via Internet.*
- *If MJPEG selected, reduce max. frame rate to min. value to save bandwidth and get better image*
- Grandstream IP Camera provides two video streams, user can use them with flexibility.  
For example, the high-resolution stream for local recording; another low or high resolution for remote monitoring; or vice versa depending application scenarios.
- *Use below link to calculate bandwidth and storage before installation*  
<http://www.grandstream.com/support/tools/bandwidth-storage-calc>

**Secondary Stream Settings**

Preferred Video Codec: H264

Resolution: 320\*240 (4:3)

Bit Rate: 512 kbps

Maximum Frame Rate: 15 fps

Bit Rate Control:  CBR  VBR

I-frame Interval: 30 Frame(1-100)

**Audio Settings**

Preferred Audio Codec: PCMU

Audio Compression: 32 kbps

Microphone Volume: 10

Speaker Volume: 7

Line In: Internal

**Power Frequency**

Power Frequency: 60 Hz

Save

**Flip Setting**

Flip:

Save

**Figure 4-2: Video & Audio Settings Page**



## Networking Setting Page

This page allows user to configure network related parameters:

**IP Address Configuration**

Dynamically Assigned via DHCP

Statically Configured as:

**DNS Configuration**

Obtain DNS Server Address Automatically

Use the Following DNS Server Address:

**HTTP**

HTTP Port:

**PPPoE**

PPPoE Account ID:

PPPoE Password:

**Figure 5: Networking Setting Page**

- **IP Address Configuration:** Camera IP address configuration
  - Dynamically Associated via DHCP: Default setting, DHCP server assign IP to camera.
  - Statically Configured as: Static IP address configuration
- **DNS Configuration:** DNS server IP, configured correctly if using static IP.
- **HTTP:** Web access TCP port, default 80.
- **PPPoE:** PPPoE account information if used.

**NOTE:**

- *If camera behind SOHO router with port forwarding configuration for remote access, static IP or static DHCP has to be used to avoid IP address change after router reboot.*
- *TCP port above 5000 suggested if port forwarding HTTP remote access, due to some ISP would block port 80 inbound traffic. For example, change the default HTTP port from 80 to 8088, to make sure the port forwarding not likely be blocked.*
- *In addition to HTTP port, RTSP port also required to be configured for port forwarding, in order for remote party viewing the H.264 video.*
- *If change the default port from TCP 80 to port “A”, then RTSP port should be “2000+A”. Both TCP port “A” and “2000+A” should be configured for port forwarding in the router. For example, the HTTP port changed to 8088, the RTSP port should be 10088, both 8088 and 10088 should be configured for port forwarding in order for remote camera video access.*
- *Camera can be configured using PPPoE to connect directly behind DSL modem in some application scenarios.*

## Wi-Fi Settings Page

This page allows user to configure Wi-Fi parameters if Grandstream USB Wi-Fi dongle plugged to the USB port on back of the camera.

- **Enable Wi-Fi:** If checked and click “Save”, a reboot is required before Wi-Fi start to work. A pop up window will show as below:

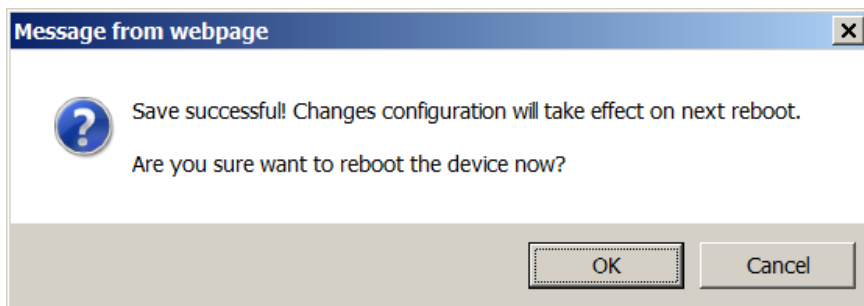

**Figure 6-1: Wi-Fi Networking Setting Page**

- **SSID:** Wi-Fi network SSID. When Wi-Fi enabled, click “Scan” the camera will scan the Wi-Fi access point nearby.
- **Key: \_** Key for security enhanced Wi-Fi network the camera try to join.
- **Security Mode:** The security mode Wi-Fi access point or router used. This parameter must be synchronized with the setting of the Wi-Fi Router or Access Point.

**Wifi Basics**

Enable Wifi:

SSID:

xfinitywifi(57)

CableWiFi(57)

31(NONE )

CableWiFi(63)

57(WPAPSK/AES )

BrooklineWireless(37)

xfinitywifi(57)

GS\_MainWiFi(100)

Key:

---

**Advanced**

Security Mode:

NONE

NONE

WEP/Shared

WEP/Open

WPA PSK TKIP

WPA PSK AES

WPA2 PSK TKIP

WPA2 PSK AES

**Figure 6-2: Wi-Fi Networking Setting Page**

**NOTE:**

- *Suggested Wi-Fi signal strength better than 75%*
- *Wi-Fi is not suggested if the environment with high interference*
- *Good Wi-Fi router or Access Point suggested as 7/24 Wi-Fi surveillance data packets could cause the radio link crashing for some models and a reboot of Wi-Fi router or AP required.*

## DDNS Settings Page

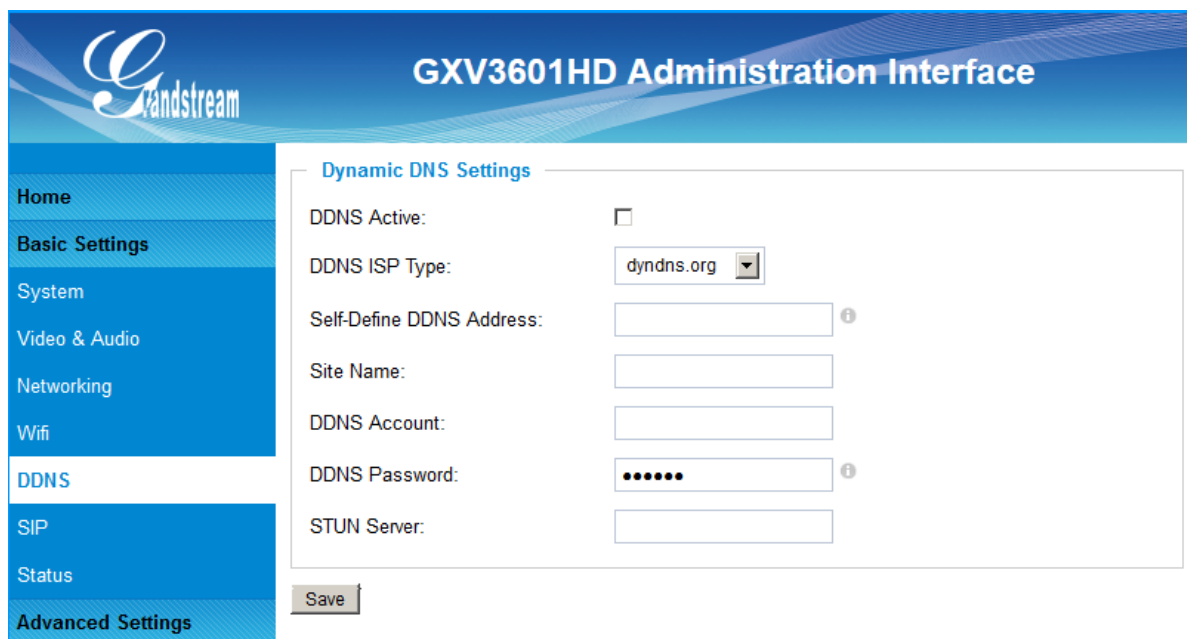

**Figure 7: DDNS Setting Page**

- ***DDNS Active:*** Enable DDNS by check this field.
- ***DDNS ISP Type:*** Select DDNS service provider from pull-down menu list
- ***Self-Define DDNS Address:*** Input the self-defined DDNS address
- ***Site Name:*** DDNS site name
- ***DDNS Account:*** DDNS account name
- ***DDNS Password:*** DDNS password
- ***STUN Server:*** Stun server FQDN or IP. If device behind a non-symmetric router, STUN server can help to resolve NAT issue.

## SIP Setting Page

This page allows user to configure SIP related parameters.

GXV3601\_HD can be configured as SIP endpoint to call out when alarm triggered, or allow permitted number to call in to check the audio/video if Grandstream IP videophone used.

**General Phone Settings**

Registered: Offline

Unregister On Reboot:

**SIP Settings**

Account Name:  ⓘ

SIP Server:  ⓘ

Outbound Proxy:  ⓘ

SIP User ID:  ⓘ

Authenticate ID:  ⓘ

Authenticate Password:  ⓘ

STUN Server:  ⓘ

Stream:  ⌵

Preferred Vocoder:  ⌵

Register Expiration(Second):  ⓘ

local SIP Port:  ⓘ

local RTP Port:  ⓘ

Auto on Hook Timer:  ⓘ

Disable Audio in SIP Call:  ⓘ

Enable Keep Alive:

Accept Direct IP Call:

Enable White List Number Filter:  ⓘ

SIP Proxy Compatibility Mode:  ⓘ

Enable Dual-way Audio Warning Mode:  ⓘ

**Figure 8-1: SIP Setting Page**

- **Registered:** SIP registration status. “Online” in Green, “Offline” in Red.
- **Unregistered on Reboot:** If checked and server support, reboot camera will unbind all registrations under same SIP account.
- **Account Name:** SIP account name
- **SIP Server:** FQDN or IP of SIP server from VoIP service provider
- **Outbound Proxy:** IP or FQDN of Outbound Proxy, helps to resolve NAT/Firewall
- **SIP User ID:** SIP username, or telephone number from ITSP

Note: You must restart the device to apply the changes.

**SIP Open Door Settings**

Enable SIP Open Door:  ⓘ

Key to Open the Door:  ⓘ

Delay Lcck Time(Secnd):  ▾

**Phone List**

Phone Number	Remark Name	Remove
<input type="text" value="6179112110"/>	<input type="text" value="Local Security Staff"/>	<input type="button" value="Add..."/>

Note: You must restart the device to apply the changes.

**White List**

Phone Number	Remove
<input type="text" value="6175669300"/>	<input type="button" value="Add..."/>

Note: You must restart the device to apply the changes.

**Figure 8-2: SIP Setting Page**

- ***Authenticate ID:*** Authenticate ID used by SIP proxy
- ***Authenticate Password:*** Authenticate password used by SIP proxy
- ***STUN Server:*** STUN server used to resolve NAT if have
- ***Steam:*** Video stream used for SIP call, default to 2<sup>nd</sup> stream
- ***Preferred Vocoder:*** Audio codec used for SIP call **(G.711u/a)**
- ***Registration Expiration:*** Registration expiration time, default 3600 seconds
- ***Local SIP Port:*** Local SIP port, default 5060
- ***Local RTP Port:*** Local RTP port for media, default 5004
- ***Auto on hook Timer:*** Auto On Hook timer, default 300 seconds
- ***Disable Audio in SIP Call:*** Checked to disable audio for SIP call
- ***Enable Keep Alive:*** Checked to enable, help NAT resolution
- ***Accept Direct IP Call:*** Check to accept peer-to-peer IP call.
- ***Enable White List Number Filter:*** Check to allow only white list number to call in.
- ***SIP Proxy Compatibility Mode:*** Check to enable more proxy compatibility with cost of bandwidth
- ***Enable Dual-way Audio Warning:*** Check to enable 2-way audio when call established. (default setting is checked and enabled)
  
- ***SIP Open Door Settings:*** Check to enable SIP Open Door Feature
- ***Key to Open the Door:*** Numeric key (as DTMF tone) to match and open door.
- ***Delay Lock Time (Second):*** Time delay for the door lock strike to restore.
  
- ***Phone List (Phone Number):*** Callee or call receiver's number when alarm call trigged.
  
- ***White List (Phone Number):*** Phone numbers allowed calling into the camera.



## Status Page

This page shows the GXV3601\_HD operation status:



The screenshot shows the 'GXV3601HD Administration Interface' with a left-hand navigation menu and three main status sections: System Statistics, Network Status, and Camera Type.

System Statistics	Value
Product Model:	GXV3601HD
Hardware Version:	V0.4B
Part Number:	9670000904B
Bootloader Version:	1.0.0.0
Core Version:	1.0.4.3
Base Version:	1.0.4.43
Firmware Version:	1.0.4.43
System Up Time Since:	2 hours 9 minutes

Network Status	Value
MAC Address:	00:0B:82:41:68:4E
LAN IP Address:	192.168.22.170
LAN Subnet Mask:	255.255.255.0
LAN Default Gateway:	192.168.22.1
PPPoE IP Address:	0.0.0.0
PPPoE Status:	Disconnected
DDNS Status:	Disabled
Wifi Status:	Disconnected
SIP Registered:	Offline

Camera Type	Value
Camera Type:	Aptina, MT9D131 Pixels 1600*1200

**Figure 9: Status Page**

**NOTE:**

- When SIP account registered, the status will display “Online” in Green.
- When SIP account unregistered, the status will display “Offline” in Red, as below.

SIP Registered: Offline

## ADVANCED SETTINGS EXPLANATION

The supports all the traditional and advanced telephony features.

### User Management Page

This page allows user to do user management:

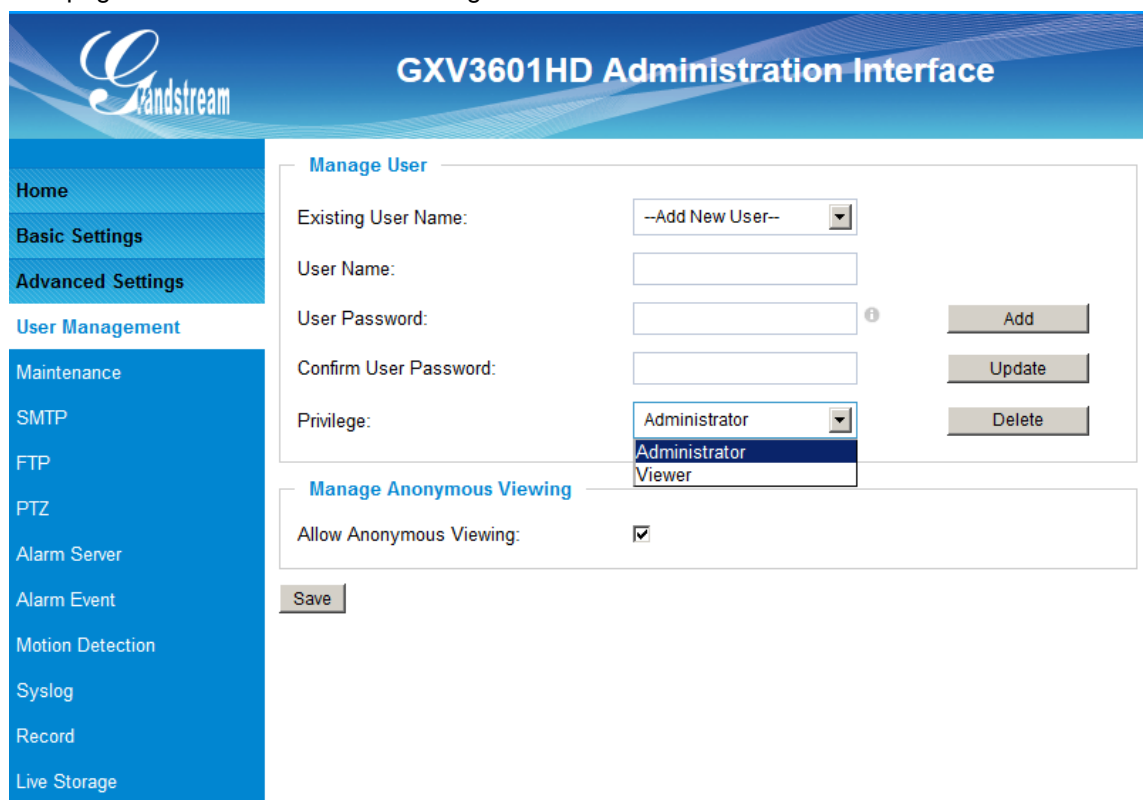

**Figure 10: User Management Page**

- **Existing User Name:** Allow revise existing user or add new user
- **User Name:** The name of user need to be revised
- **User Password:** New password if revise password
- **Confirm User Password:** Re-enter the new password for verification
- **Privilege:** Choose user privilege
- **Allow Anonymous Viewing:** When checked, no security enhanced. Any person can view the camera if knowing the IP or FQDN of the camera, but cannot change anything, just view ONLY.

## Maintenance Page

This page allows user to maintain the camera:



The screenshot shows the 'GXV3601HD Administration Interface' with a left-hand navigation menu. The 'Maintenance' section is active, showing three main options: 'Restart the device', 'Restore the device', and 'Firmware Upgrade and Provisioning'. The 'Restart the device' section has a 'Restart' button. The 'Restore the device' section has a 'Restore' button. The 'Firmware Upgrade and Provisioning' section includes fields for 'Upgrade via' (set to HTTP), 'Firmware Server Path' (firmware.grandstream.com), 'Config Server Path' (config.grandstream.com), 'XML Config File Password' (masked with dots), 'Automatic Upgrade Interval (Minutes)' (10080), and 'Automatic Upgrade' (checked). A 'Save' button is located at the bottom of the form.

**Figure 11: Maintenance Page**

- **Restart:** When clicked, the camera will reboot or restart
- **Restore:** When clicked, the camera will be reset to factory default, wiping out all the configurations (except IP address)

### **Firmware Upgrade and Provisioning:**

- ***Upgrade via:*** Upgrade firmware via TFTP, HTTP or HTTPS
- ***Firmware Server Path:*** Server path holding the firmware
- ***Config Server Path:*** Server path holding the configuration file (auto provisioning)
- ***XML ConfigFile Password:*** Password for encrypt the XML based configuration file
- ***Automatic Upgrade Interval (Minutes):*** Time interval for automatic upgrade, default 10080
- ***Automatic Upgrade:*** Checked to enable automatic firmware upgrade and provisioning.

### **NOTE:**

- *Only XML based automatic provisioning is supported by GXV3601\_HD.*

## SMTP Setting Page (Email Alarm)

This page allows user to configure email client to send out email when alarm triggered:

### SMTP Server Settings

Enable SMTP:

SMTP Server:

SMTP Server Port:

From E-Mail address:

To E-Mail address 1:

To E-Mail address 2:

To E-Mail address 3:

User Name:

Password:  ⓘ

SSL:  ⓘ

Email Subject:  ⓘ

Email Content: 

There is something wrong in the front door.  
Please check out immediately:

<http://IPCam.myDDNS.org:10020>  
(Port Mapped via Router)

 ⓘ

<sup>1</sup> Required Fields.  
<sup>2</sup> Valid DNS server is required for hostname.

Figure 12: SMTP Setting Page

- **Enable SMTP:** When checked, email client is enabled.
- **SMTP Server:** SMTP Email Server IP or Domain Name
- **SMTP Server Port:** Port number used by server to send email
- **From Email address:** The email address of alarm email sending from, usually client email ID
- **To E-Mail address:** The email address to receive the alarmed email, total 3 included.
- **User Name:** Email client User ID
- **Password:** Email client password
- **SSL:** Check if the SMTP email server requires SSL
- **Email Subject:** Customizable email subject for user convenience
- **Email Content:** Customizable email body for user convenience

**NOTE:**

- Click “Save” to save the email configuration information.
- Click “Test” after configuration, if setting is correct, a test email will send out and “Test successful!” orange bar will display like below

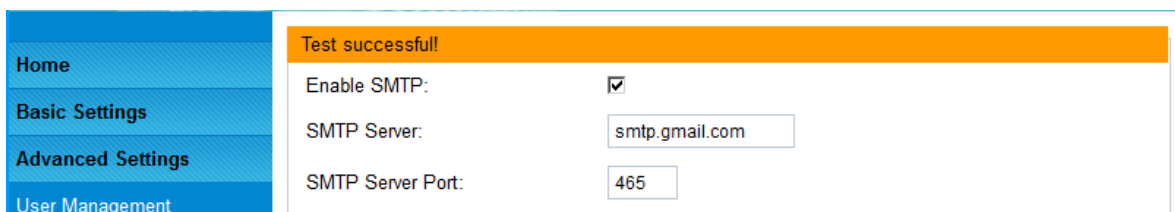

Home	Test successful!
Basic Settings	Enable SMTP: <input checked="" type="checkbox"/>
Advanced Settings	SMTP Server: <input type="text" value="smtp.gmail.com"/>
User Management	SMTP Server Port: <input type="text" value="465"/>

## FTP Settings Page (Upload Alarm)

This page allows user to configure FTP parameters to upload the alarm or video recording::

**FTP Settings**

Enable FTP:

FTP Server:

FTP Server Port:

User Name:

Password:  ⓘ

Path:

Valid DNS server is required for hostname.

**Figure 13: FTP Setting Page**

- **Enable FTP:** When checked, built-in FTP client is enabled.
- **FTP Server:** IP or Domain name of FTP site or server
- **FTP Server Port:** TCP port for FTP server, default port number 21
- **User Name:** FTP server User ID
- **Password:** FTP server user password
- **Path:** Path in the server where upload files are stored.

**NOTE:**

- Click “Save” to save the FTP configuration information.
- Click “Test” after configuration, if setting is correct, a test FTP operation will be performed and “Test successful!” orange bar will display if the operation is successful.

## PTZ Control Settings Page

This page configures the PTZ settings.

1. Select the **PTZ protocol** that the connected device supporting from the pull-down list (Pelco-D/C)
2. Next, select the correct **Baud Rate** from the drop down menu to match the connected device.
3. If multiple devices used, please select right address ID based on the 3<sup>rd</sup> party device user manual (the PIN switch address) here.



The screenshot shows the 'GXV3601HD Administration Interface' with a left-hand navigation menu. The 'PTZ' option is selected and highlighted in white. The main content area is titled 'PTZ Settings' and contains three configuration fields: 'Protocol' set to 'Pelco-D', 'Baudrate' set to '9600 bit/s', and 'Address ID' set to '1' with a range of '(1-255)'. A 'Save' button is located below these fields.

Figure 14: PTZ Setting Page

## Connect a PTZ device to the GXV3601\_HD

1. Connect the 3<sup>rd</sup> party PTZ device to GXV3601\_HD by following the connection diagram shown below

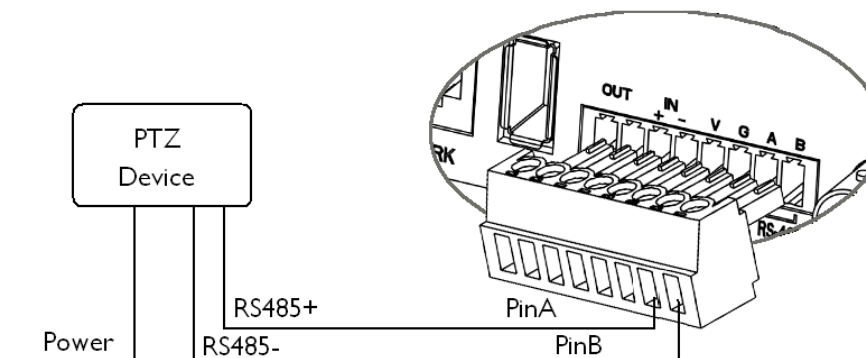

2. In *Advanced Settings*, select **PTZ** tab, configure the **PTZ Protocol** and **Baudrate** according to the connected PTZ device (refer to previous page)
3. Click **Save** and reboot the device to apply all changes.
4. Use those PTZ buttons on the WebGUI homepage to tilt, pan the GXV3601\_HD, also adjust the speed.

### **NOTE:**

- *GXV3601\_HD* itself does NOT support PTZ. The supported device must be connected to the RS485 pins to Pan, Tilt.
- The **FOCUS** and **Zoom** function may not work if 3<sup>rd</sup> party device not supported
- Press and hold the corresponding control button to adjust the Pan, Tile and Speed.



## Alarm Server Settings Page

This page allows user to configure alarm HTTP server to upload alarms to supported VMS server or HTTP server:

### Alarm HTTP Server Settings

Server Name:	<input type="text" value="Security_Solutions"/>
URL:	<input type="text" value="server911.cloud.net:9999"/>
User Name:	<input type="text" value="subscriber_110"/>
Password:	<input type="password" value="....."/>

**Figure 15: Alarm HTTP Server Setting Page**

- **Server Name:** The name of HTTP server or VMS system
- **URL:** URL or FQDN of the Server
- **User Name:** User ID from that Server
- **Password:** Password for that User ID

### **NOTE:**

- *Grandstream provide HTTP API to help third party companies by using HTTP server or VMS to develop further solutions for their customers.*

[http://www.grandstream.com/products/surveillance/general/documents/grandstream\\_http\\_api.pdf](http://www.grandstream.com/products/surveillance/general/documents/grandstream_http_api.pdf)

- *Grandstream IP Camera and Encoder (include GXV3601\_HD) are ONVIF certified.*

## Alarm Event

The GXV3601\_HD supports alarm event input and output. For example, 3<sup>rd</sup> party infrared detector, smoke detector, siren and so on, can be plugged to the Alarm In/Out port if their parameters matching the requirement of the DI/DO Port of GXV3601\_HD:

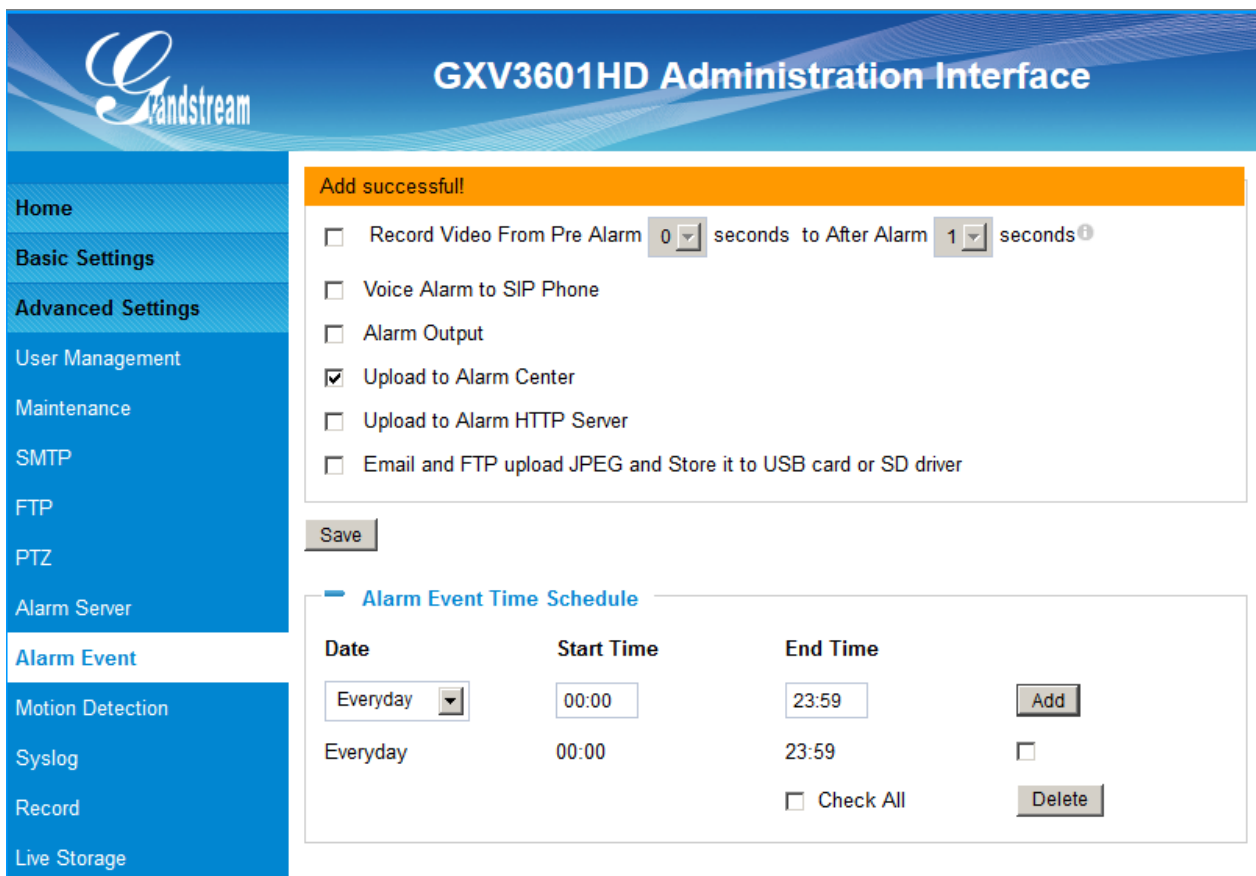

The screenshot shows the 'GXV3601HD Administration Interface' with a left-hand navigation menu. The 'Alarm Event' section is active, showing a list of settings:

- Record Video From Pre Alarm  seconds to After Alarm  seconds ⓘ
- Voice Alarm to SIP Phone
- Alarm Output
- Upload to Alarm Center
- Upload to Alarm HTTP Server
- Email and FTP upload JPEG and Store it to USB card or SD driver

A 'Save' button is located below these settings. Below the settings is the 'Alarm Event Time Schedule' section, which contains a table:

Date	Start Time	End Time	
Everyday <input type="text" value="▼"/>	<input type="text" value="00:00"/>	<input type="text" value="23:59"/>	<input type="button" value="Add"/>
Everyday	00:00	23:59	<input type="checkbox"/>

At the bottom of the schedule section, there is a checkbox for 'Check All' and a 'Delete' button.

**Figure 16: Alarm Event Setting Page**

Follow the steps to make Alarm Input work:

1. Connect alarm input or output equipment to the GXV3601\_HD Alarm In or Out port.
2. Set up the alarm event time schedule from the WebGUI.
3. Configure the alarm actions which you would like the GXV3601\_HD to do when alarm or event is triggered.

## How Alarm\_Input and Alarm\_Output Work

“Alarm\_In” is the alarm input port. Users are able to connect 3<sup>rd</sup> party sensors such as infrared sensor, smoke sensor or light sensor to it.

The detectable signal voltage range for “Alarm-In” is from **1.8V to 15 V**

“Alarm-Out” uses relays as a switch (**30VAC/2A**). Users can connect 3<sup>rd</sup> party devices such as alarm siren or alert light to this port. Under normal circumstances, the circuit is open. When there is an alarm event, the GXV3601\_HD will close the circuit to trigger the alarm.

### **NOTE:**

- *Please do NOT connect a device that has a signal voltage higher than 15V, this will damage the GXV3601\_HD.*

## How to connect an Alarm Output Equipment to GXV3601\_HD

Here is a sample connection diagram. Connect the alarm output equipment to the GXV3601\_HD by following the diagram below.

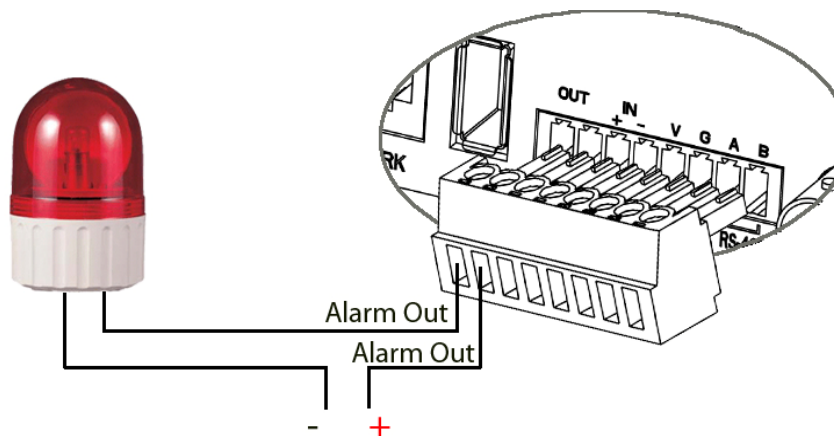

## How to connect an Alarm Input Equipment to GXV3601\_HD

Here are two sample connection diagrams.

Connect the alarm equipment to the GXV3601\_HD by following the diagram below.

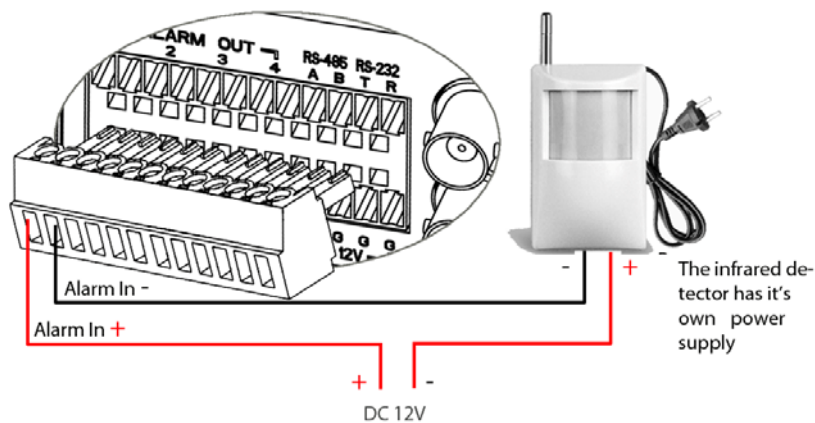
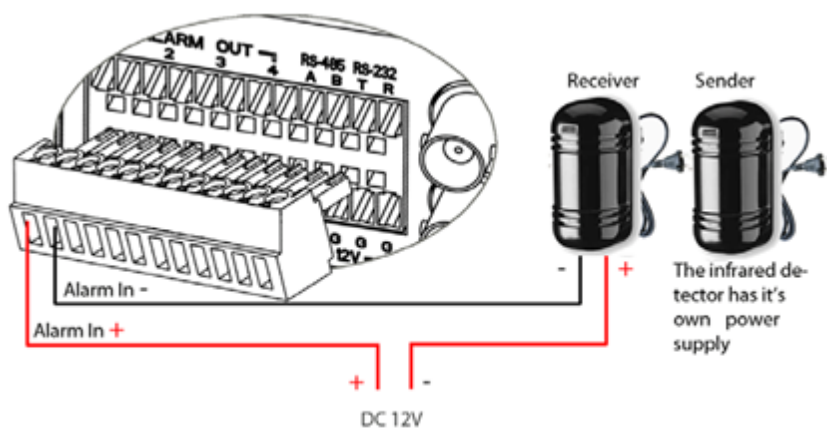

## DI Alarm Action:

This tab configure how the GXV3601\_HD takes action when 3<sup>rd</sup> party DI/DO triggered:

- **Record Video:** Record video based on configured Pre/Pro Alarm intervals to VMS, server or internal SD card if plugged.
- **Voice Alarm to SIP Phone:** Alarm SIP phone call to configured Grandstream Video/Audio phones in the Phone List page using the configured SIP account when an alarm is triggered.
- **Alarm Output:** If checked the alarm will output via the configured method or equipment when alarm is triggered.
- **Upload to Alarm Center:** Integrated with GSurf\_Pro. If checked the GXV3601\_HD will report the alarm event to GSurf\_Pro
- **Upload to Alarm HTTP Server:**
- **Record Video and Upload to FTP Server:**
- **Email and FTP uploaded JPEG and Store it to USB card or SD driver**

**Voice Alarm to SIP Phone** – If this option is selected, the GXV3601\_HD will make calls to the number listed in the **Phone List** page using the configured SIP account when an alarm is triggered. To use this function, the settings in **SIP** page must be configured properly. **Alarm**

**Output** – If this option is selected, the alarm will output via the configured method/equipment when it is triggered.

**Upload to Alarm Center** – This option is an integrated feature with GSurf\_Pro. If this option is checked, the GXV3601\_HD will report the alarm event to GSurf\_Pro.

**Record Video and Upload to FTP server** – If this option is selected, the GXV3601\_HD will record the video and upload it to the FTP server when an alarm is triggered. You must check Record Video and configure the FTP page properly to use this feature.

**Email JPEG and Store it to USB drive or SD card** – If this option is selected, the GXV3601\_HD will capture the image and store it to connected live storage device when an alarm is triggered.

## Alarm Event Time Schedule Setup

This section allows you to configure the time during which the GXV3601 will monitor the Alarm Input. The GXV3601 not only can monitor your settings but also can take actions when the alarm is triggered.

Dropdown list for date

Available

time

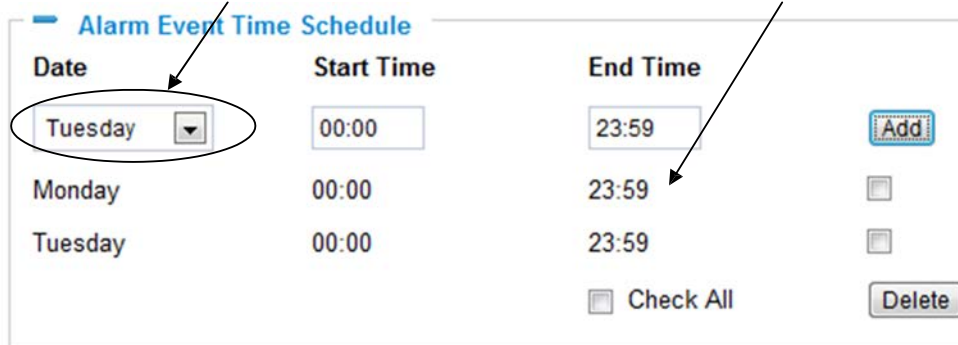

Date	Start Time	End Time	
Tuesday	00:00	23:59	<input type="button" value="Add"/>
Monday	00:00	23:59	<input type="checkbox"/>
Tuesday	00:00	23:59	<input type="checkbox"/>
			<input type="checkbox"/> Check All

To add a schedule, select the *date* from the dropdown list, *Start Time* and *End time* and Click *Add* to add a new time schedule.

To delete a schedule, check the schedule you would like to remove and click *Delete*.

## Motion Detection Configuration Page (Set Alarm)

This page allows user to configure motion detection to trigger alarms:

### Motion Detection Region Settings

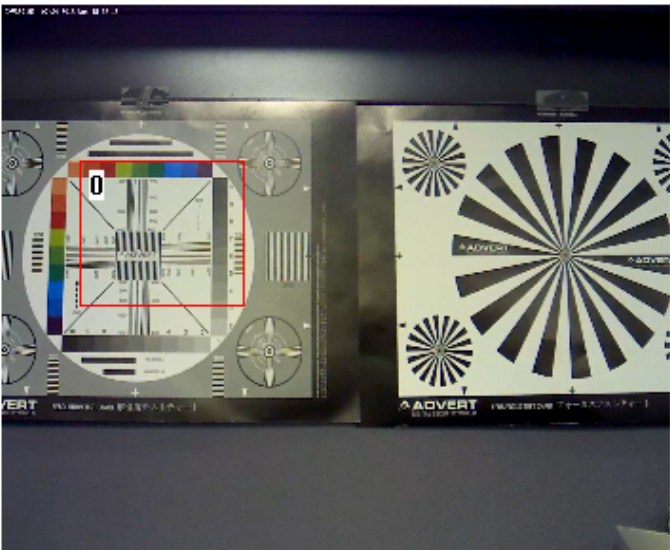

Enable Motion Detection  
 Show Motion Detection Regions  

0 Select a Region

50 Sensitivity Save

Edit
Remove
Save

### Alarm Action

- Record Video From Pre Alarm 10 seconds to After Alarm 15 seconds ⓘ
- Voice Alarm to SIP Phone
- Alarm Output
- Upload to Alarm Center
- Upload to Alarm HTTP Server
- Record Video and Upload to FTP Server
- Email and FTP upload JPEG and Store it to USB card or SD driver

Save

### Motion Detection Time Schedule

Region ID	Date	Start Time	End Time	
0	Everyday	00:00	23:59	<span style="border: 1px solid #ccc; padding: 2px 10px;">Add</span>

**Figure 17-1: Motion Detection Configuration Page**

- **Enable Motion Detection:** When checked, Motion Detection enabled.
- **Show Motion Detection Regions:** When checked, Motion Detection region with number will be displayed in White Rectangle in the screen; when “Edit” clicked, the Rectangle will become Red, as shown in Figure 16-1.
- **Select a Region:** Pull down to select and configure alarm region, altogether 16 alarm region available, from 0 to 15.
- **Sensitivity:** Select configured alarm region number, input number for sensitivity to trigger alarm, 100 is the maximum sensible value.

#### Alarm Action:

- **Record Video From.....:** Allow user to configure how long pre/post alarm trigger moment, the video to be captured by the camera.
- **Voice Alarm to SIP Phone:** When checked and SIP proxy configured and IPCam registered, SIP alarm call will be made to pre-configured number.
- **Upload to Alarm Center:** When checked, the alarm video will be transferred to Alarm Center, like Grandstream free GSurf\_Pro VMS software.
- **Upload to Alarm HTTP Server:** When checked, the alarm will be sent to Alarm HTTP Server. Third Party Server also can be used via GS HTTP API
- **Record Video and Upload...:** When checked and FTP server configured, the recorded video will be FTPed to the configured FTP server.
- **Email and FTP upload JPEG:** When checked, snapshots of trigger moment will be generated and be emailed to pre-configured email account, also upload to FTP server if configured.

#### NOTE:

- Grandstream free GSurf\_Pro VMS software can be downloaded here:  
[http://www.grandstream.com/products/tools/surveillance/gsurf\\_pro.zip](http://www.grandstream.com/products/tools/surveillance/gsurf_pro.zip)

#### Motion Detection Time Schedule:

This page allows user to configure Motion Detection Operation Schedule:

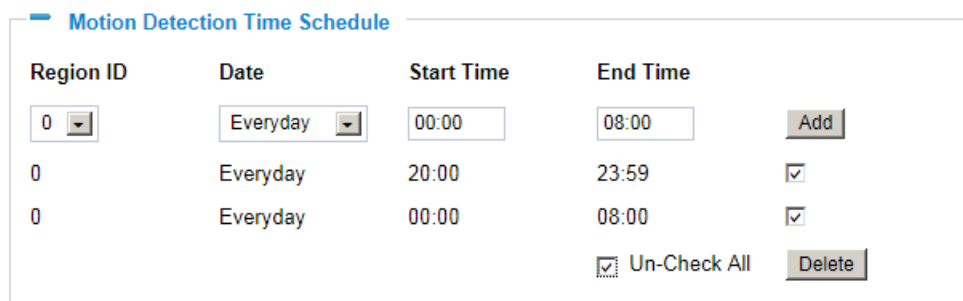

The screenshot shows a table for configuring motion detection schedules. It has columns for Region ID, Date, Start Time, and End Time. There are three rows of data, each with an 'Add' button. The first row has Region ID 0, Date Everyday, Start Time 00:00, and End Time 08:00. The second row has Region ID 0, Date Everyday, Start Time 20:00, and End Time 23:59. The third row has Region ID 0, Date Everyday, Start Time 00:00, and End Time 08:00. There are also 'Un-Check All' and 'Delete' buttons at the bottom.

Region ID	Date	Start Time	End Time	
0	Everyday	00:00	08:00	Add
0	Everyday	20:00	23:59	<input checked="" type="checkbox"/>
0	Everyday	00:00	08:00	<input checked="" type="checkbox"/>
				<input checked="" type="checkbox"/> Un-Check All
				Delete

**Figure 17-2: Motion Detection Schedule Configuration Page**

- As shown in Figure 15-2, user can configure the Motion Detection Region with related Start and Stop time to control the motion detection operation.



## Syslog Settings Page (Troubleshooting)

This page allows user to enable the Syslog to help troubleshooting problems:

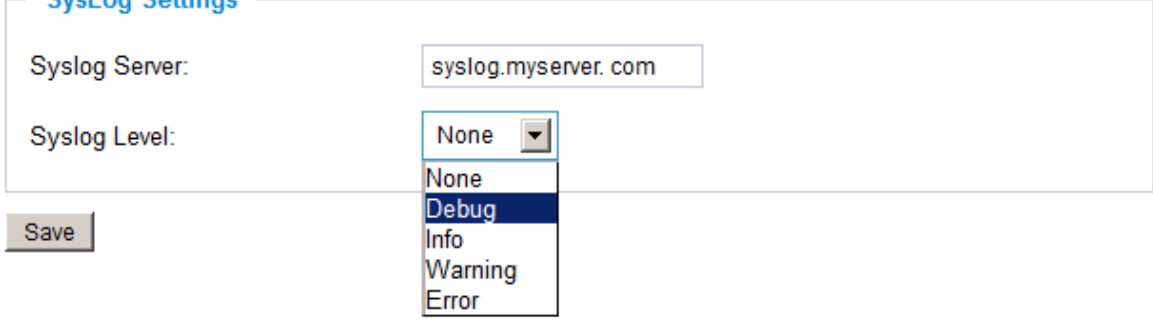

**SysLog Settings**

Syslog Server:

Syslog Level:  ▼

- None
- Debug**
- Info
- Warning
- Error

**Figure 18: Syslog Setting Page**

- **Syslog Server:** Syslog server IP or Domain Name
- **Syslog Lever:** Lever of syslog message sent to the syslog server:  
*None, Debug, Info, Warning, Error.*

## Record Settings Page (Local DVR Record Schedule)

This page allows user to configure SD card Record Schedule:

**Record Settings**

Enable Record Schedule:

	0	1	2	3	4	5	6	7	8	9	10	11	12	13	14	15	16	17	18	19	20	21	22	23	
S																									
M																									
T																									
W																									
T																									
F																									
S																									

Copy: Sunday ▼      To: All ▼      Copy

Save

---

**Manual Recording**

Manual Recording: Start

**Figure 19: Record Time Schedule Setting Page**

- Enable Record Schedule:**  
When checked it will enable Scheduled Recording on SD card.  
Click the related block, the grey colored time block means there is a scheduled recording.
- Manual Recording:**  
When clicked and if there is NO scheduled recording, the GXV3601\_HD will start recording.

## Live Storage Setting Page (SD card File Management)

This page allows user to manage the recorded files in SD card:

**On Disk Full**

Delete the earliest video or image files <sup>?</sup>

Stop storing video and image files <sup>?</sup>

**Format**











Format SD Card:

Format USB Flash Drive:

**Storage Information**

Type	Capacity	Used Space	Free Space	Use(%)	Unmount
SD	30417M	1207M	29209M	3.97%	<input type="button" value="Unmount"/>

**JPEG List**

File Name	Size	View	Check
192.168.1.99_chn1_2013_07_29_13_07_43.jpg	0.577M		<input type="checkbox"/>
192.168.1.99_chn1_2013_07_29_13_07_33.jpg	0.557M		<input type="checkbox"/>
192.168.1.99_chn1_2013_07_29_12_49_10.jpg	0.567M		<input type="checkbox"/>
192.168.1.99_chn1_2013_07_29_12_46_37.jpg	0.655M		<input type="checkbox"/>
192.168.1.99_chn1_2013_07_29_12_46_05.jpg	0.634M		<input type="checkbox"/>
192.168.1.99_chn1_2013_07_29_12_37_14.jpg	0.611M		<input type="checkbox"/>
192.168.1.99_chn1_2013_07_29_12_36_49.jpg	0.551M		<input type="checkbox"/>
192.168.1.99_chn1_2013_07_29_12_30_18.jpg	0.618M		<input type="checkbox"/>
192.168.1.99_chn1_2013_07_29_12_23_13.jpg	0.542M		<input type="checkbox"/>
192.168.1.99_chn1_2013_07_29_12_20_04.jpg	0.597M		<input type="checkbox"/>

Pages:200 Total:1997 Index:1-10 Goto:    Check All

**Video List**

File Name	Size	Download	Check
-----------	------	----------	-------

**Figure 20: Live Storage – SD card File Management Page**

- ***On Disk Full:***  
Select below two different operations when SD card is full
  - Delete the earliest video or image files
  - Stop storing video and image files
  
- ***Storage Information:***  
The SD card information will be displayed in this column.
  
- ***JPEG List:***  
Motion triggered Snapshot JPEG file will be listed here.
  
- ***Video List:***  
Motion triggered video recording clip will be listed here.

## Software Upgrade

Software upgrade can be done via either TFTP, HTTP or HTTPS. The corresponding configuration settings are in the ADVANCED SETTINGS configuration page.

### Software Upgrade via TFTP, HTTP or HTTPS

This page allows user to configure firmware upgrade:

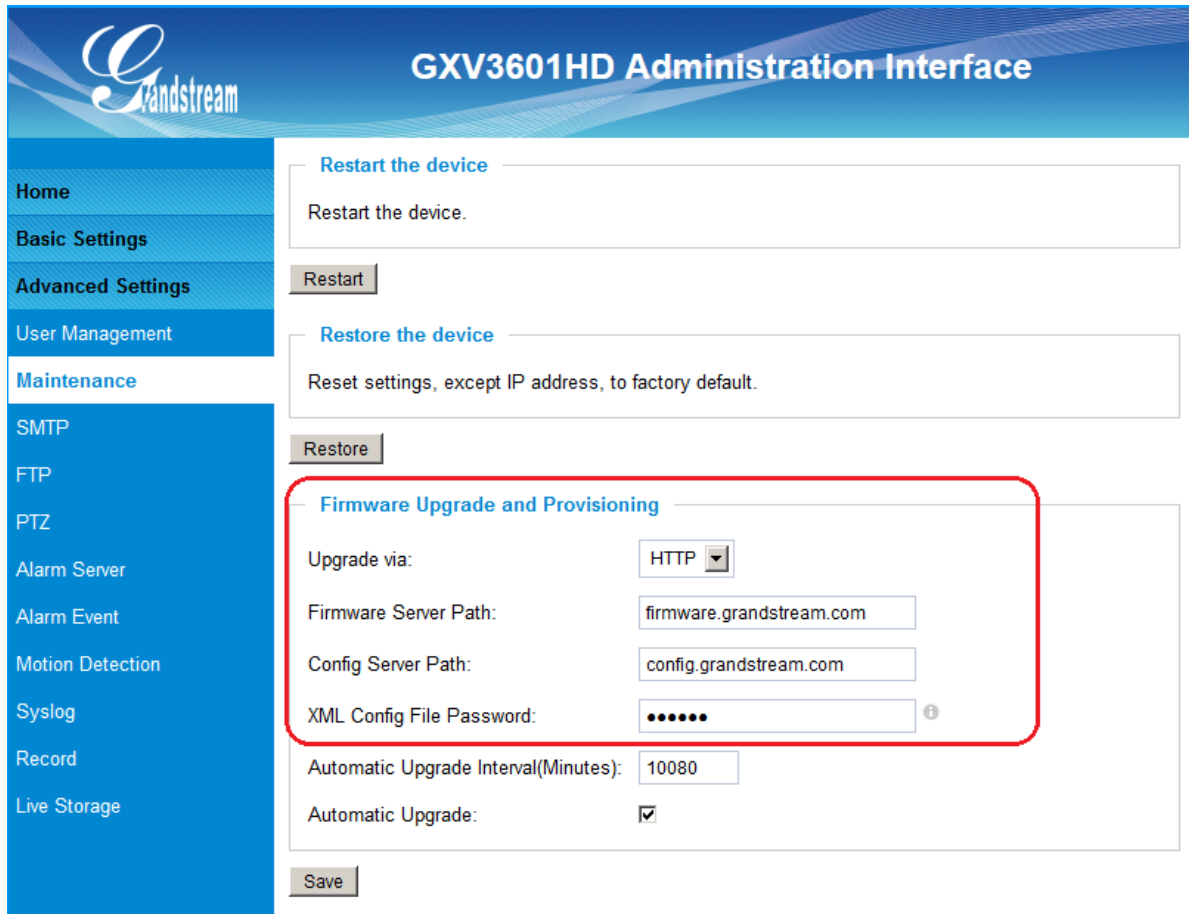

**Figure 21: Firmware Upgrade and Provisioning**

**NOTE:**

- Grandstream recommends end-user use the Grandstream HTTP server.
- Currently the HTTP firmware server is [firmware.grandstream.com](http://firmware.grandstream.com). For large companies or user without Internet connection, we recommend maintaining their own TFTP/ HTTP/HTTPS server for upgrade and provisioning procedures.

## Instructions for local firmware upgrade using TFTP server:

1. Unzip the file and put all of them under the root directory of the TFTP server.
2. Put the PC running the TFTP server and the device in the same LAN segment.
3. Please go to File -> Configure -> Security to change the TFTP server's default setting from "Receive Only" to "Transmit Only" for the firmware upgrade.
4. Start the TFTP server, in the phone's web configuration page
5. Configure the Firmware Server Path with the IP address of the PC
6. Update the change and reboot the unit

End users can also choose to download the free HTTP server from <http://httpd.apache.org/> or use Microsoft IIS web server.

## Configuration File Download

Grandstream SIP Device can be configured via Web Interface as well as via Configuration File through TFTP or HTTP/HTTPS. "Config Server Path" is the TFTP or HTTP/HTTPS server path for configuration file. It needs to be set to a valid URL, either in FQDN or IP address format. The "Config Server Path" can be same or different from the "Firmware Server Path".

A configuration parameter is associated with each particular field in the web configuration page. A parameter consists of a Capital letter P and 1 to 3 (Could be extended to 4 in the future) digit numeric numbers. i.e., P2 is associated with "Admin Password" in the ADVANCED SETTINGS page. For a detailed parameter list, please refer to the corresponding firmware release configuration template.

When Grandstream Device boots up or reboots, it will issue request for configuration file named "cfgxxxxxxxxxxxx.xml", where "xxxxxxxxxxxx" is the MAC address of the device, i.e., "cfg000b820102ab.xml". The configuration file name should be in lower cases.

**Currently GXV3601\_HD only support XML configuration.**

## RESTORE FACTORY DEFAULT SETTING

### WARNING!

Restoring the Factory Default Setting will DELETE all configuration information of the camera. Please BACKUP or PRINT out all the settings before approach to following steps. Grandstream will not take any responsibility if you lose all the parameters of setting or cannot connect to your VoIP service provider.

### FACTORY RESET

### Reset from Web Interface

This page allows user to configure dynamic network related parameters:

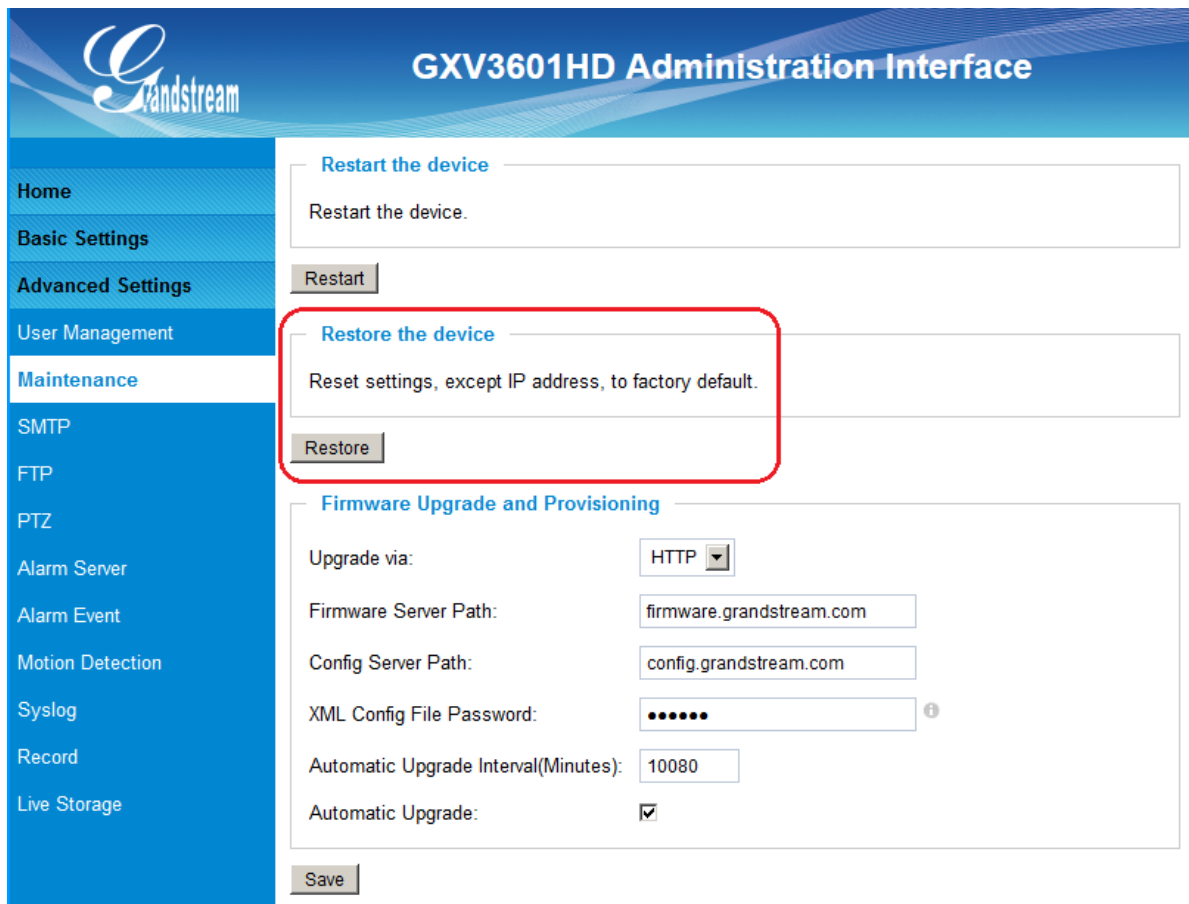

The screenshot displays the 'GXV3601HD Administration Interface' with a blue sidebar on the left containing navigation links: Home, Basic Settings, Advanced Settings, User Management, Maintenance, SMTP, FTP, PTZ, Alarm Server, Alarm Event, Motion Detection, Syslog, Record, and Live Storage. The main content area is divided into three sections: 'Restart the device' with a 'Restart' button, 'Restore the device' (highlighted with a red box) with a 'Restore' button, and 'Firmware Upgrade and Provisioning' with fields for 'Upgrade via' (HTTP), 'Firmware Server Path' (firmware.grandstream.com), 'Config Server Path' (config.grandstream.com), 'XML Config File Password' (masked with dots), 'Automatic Upgrade Interval(Minutes)' (10080), and 'Automatic Upgrade' (checked). A 'Save' button is located at the bottom of the interface.

Figure 22: Factory Reset from Web Interface

## IP SURVEILLANCE FAQ

### **1. What is the default IP address of the GXV3601\_HD?**

A: The default IP configuration is DHCP.

### **2. Why can I not view the live video stream in Microsoft Internet Explorer?**

A: Please double check whether the Grandstream Plug-in/Active-X is installed correctly. Once you log into the GXV3601\_HD web interface, Internet Explorer will indicate that this website wants to install to following add-on: GSViewer. cab' from Grandstream Networks, Inc. Please install this add-on when prompted by IE.

### **3. How do you manually uninstall the Grandstream video viewer add-on for IE?**

Please follow these steps to uninstall the add-on:

1. Delete the *GSViewerX Control* from *C:\WINDOWS\Downloaded Program Files* directory
2. Delete *GSNetClient.dll*, *GS\_Replay.exe*, *GSViewerX.ocx*, *hi\_h264dec\_w.dll*, *lik\_VoiceEngine\_dll.dll* and *GSViewerX.inf* from *C:\WINDOWS\system32*

### **4. Why can't I access the GXV3601\_HD web configuration interface?**

Q 1: Is your internet service down?

A 1: Connect a PC to the internet to test the connection.

Q 2: Are the PC and the device in different subnets?

A 2: Check the subnet mask and default gateway of the device and PC.

Q 3: Is there a conflict with another IP address?

A 3: Try to change the IP address of the device.

Q 4: Has the HTTP port been changed?

A 4: Contact the administrator of the device for more information.

### **5. The GXV3601\_HD web configuration page is not displayed correctly in IE8 ?**

In IE8, Compatibility View might need to be enabled for the GXV3601\_HD web configuration page to load properly. To enable compatibility view, open IE8, click *Tools, Compatibility View Setting*, and add the GXV3601\_HD web configuration pages to the Compatibility View.



**6. Why does IE indicate to install Grandstream Video Viewer add-on after a firmware upgrade? The add-on was properly installed before the firmware upgrade process.**

New firmware will often upgrade the add-on as well. To watch the live video stream, you must install the newest version of the add-on.

**7. How do you watch secondary video stream?**

Login to the home page of the GXV3601\_HD web GUI, click Play to watch the video stream. To watch a secondary video stream, right click on the video, and select *Secondary Stream* on the pop-up menu. Try reinstalling the Grandstream Viewer add-on for IE if you cannot see the video stream.

**8. What is DDNS? Is it important for IP surveillance product to have DDNS support?**

DDNS is an acronym for Dynamic Domain Name Service. It is important to choose an IP network camera that has DDNS support for dynamic IP addresses. Chances are that the network has a dynamic IP address (which changes with every log on). A DDNS service makes sure that the camera's IP address always matches up to the current server address. DDNS also allows a website to be linked to the IP camera that is constantly updated with the correct information and has a reliable feed.

**9. Why is Windows Media Player unable to play the recorded video files?**

The GXV3601\_HD uses the H.264 video codec. Windows Media Player may lack the proper H.264 decoder to play the recorded video. Please download the Microsoft FFDSHOW H.264 decoder from <http://sourceforge.net/projects/ffdshow-tryout/> and install it.

**10. Alarm Triggered Events do not work with GSurf\_Pro?**

Please double check the Alarm Action on your GXV3601\_HD. Login to the web GUI of the GXV3601\_HD, go to the Motion Detection or Alarm Events page, and make sure option Upload to Alarm Center is checked.

**11. Recommended to save the video files in different directories when using GSurf\_Pro?**

It is better to save video files in different directory to prevent accidental deletion of the recorded files you need.

**12. How to use a cell phone to watch the GXV3601\_HD video stream?**

You must set the video resolution to QCIF to watch the GXV3601\_HD video stream from a cell phone. Make sure to set the bit rate to 64kbps to ensure the best video quality.

**13. What Smartphone application should I use to view the video?**

There are free application and paid version application for this, like: IP Cam Viewer

<http://hit-mob.com/>

**14. Why the IP address of the device NOT reset when clicking the “Restore” button?**

The GXV3601\_HD could be installed in areas that are not easy to access. For example, it could be installed on the roof of a building or the ceiling of an office. This makes it difficult to reinstall the device, therefore the “Restore” function will not clear the IP address.

**15. Why can't the live video stream be viewed using a mobile phone or GSurf\_Pro after changing the HTTP Port of the device?**

Make sure that the RTSP port of the device is set to 2000 plus the HTTP Port number. For example, if the HTTP port is 88, then the RTSP port of the device that you configured on GSurf\_Pro or mobile phone should be 2088.

**16. Port forwarding**

Two ports must be forwarded on your router to watch video from a GXV3601\_HD that is located on a private network from a PC in a public network. The web port (HTTP) and the RTSP port. Please make note that the RTSP port number changes according to the web port. If the web port is 80, then the RTSP port is 554. If the web port is not 80, then the RTSP port equals the web port +2000. For example, if the web port is 88, then the RTSP port will be 2088.

**17. Tested PC display adapters.**

<b>Display Adapter</b>	<b>Test Result</b>
SiS 650/651/740/661 FX/741/760 Series	Works normally
Intel® 82945R Express Chipset Family	Works normally

VIA/S3G UniChrome Pro IGP	Works normally
NVIDIA Geforce 7300GS	Works normally
SiS 661FX	Works normally
SiS Mirage Graphics	Works normally
SiS 661 Series	Works normally
Intel® G33/G31 Express	Works normally
SiS Mirage3 Graphics	Works normally
SiS 661FX/GX Mirage Graphics	Works normally
S3 Graphics ProSavageDDR(Microsoft Corporation)	Works normally
XGI Velari Z7/Z9/Z9S V1.08.12	There is some delay when playing videos.
Intel® 965 Express Chipset Family	Works normally
ATI Mobility Radeon X1300	Works normally
Intel® G45/G43 Express Chipset	Works normally
Mobile Intel 965 Express Chipset Family	Works normally
Mobile Intel® 4 Series Express Chipset Family	Works normally
Mobile Intel® 945GM Express Chipset Family	Works normally
Mobile intel® 915GM/GMS, 910GML Express Chipset Family	Works normally
Intel® G45/G43 Express Chipset	Works normally
ATI Technologies, RAGE XL PCI	This display adapter cannot display videos.