

Yealink



Yealink Color-screen Expansion Module EXP50 User Guide

Version 1.0
Apr. 2017

Copyright

Copyright © 2017 YEALINK(XIAMEN) NETWORK TECHNOLOGY CO., LTD.

Copyright © 2017 Yealink(Xiamen) Network Technology CO., LTD. All rights reserved. No parts of this publication may be reproduced or transmitted in any form or by any means, electronic or mechanical, photocopying, recording, or otherwise, for any purpose, without the express written permission of Yealink(Xiamen) Network Technology CO., LTD. Under the law, reproducing includes translating into another language or format.

When this publication is made available on media, Yealink(Xiamen) Network Technology CO., LTD. gives its consent to downloading and printing copies of the content provided in this file only for private use and not for redistribution. No parts of this publication may be subject to alteration, modification or commercial use. Yealink(Xiamen) Network Technology CO., LTD. will not be liable for any damages arising from use of an illegally modified or altered publication.

Warranty

THE SPECIFICATIONS AND INFORMATION REGARDING THE PRODUCTS IN THIS GUIDE ARE SUBJECT TO CHANGE WITHOUT NOTICE. ALL STATEMENTS, INFORMATION, AND RECOMMENDATIONS IN THIS GUIDE ARE BELIEVED TO BE ACCURATE BUT ARE PRESENTED WITHOUT WARRANTY OF ANY KIND, EXPRESS OR IMPLIED. USERS MUST TAKE FULL RESPONSIBILITY FOR THEIR APPLICATION OF PRODUCTS.

YEALINK(XIAMEN) NETWORK TECHNOLOGY CO., LTD. MAKES NO WARRANTY OF ANY KIND WITH REGARD TO THIS GUIDE, INCLUDING, BUT NOT LIMITED TO, THE IMPLIED WARRANTIES OF MERCHANTABILITY AND FITNESS FOR A PARTICULAR PURPOSE. Yealink(Xiamen) Network Technology CO., LTD. shall not be liable for errors contained herein nor for incidental or consequential damages in connection with the furnishing, performance, or use of this guide.

Declaration of Conformity



Hereby, Yealink(Xiamen) Network Technology CO., LTD. declares that this phone is in conformity with the essential requirements and other relevant provisions of the CE, FCC.

CE Mark Warning

This device is marked with the CE mark in compliance with EC Directives 2014/35/EU and 2014/30/EU.

Industry Canada (IC)

This Class [B] digital apparatus complies with Canadian ICES-003 Rules.

Part 15 FCC Rules

This device is compliant with Part 15 of the FCC Rules. Operation is subject to the following two conditions:

1. This device may not cause harmful interference, and
2. This device must accept any interference received, including interference that may cause undesired operation.

Class B Digital Device or Peripheral

Note: This equipment has been tested and found to comply with the limits for a Class B digital device, pursuant to part 15 of the FCC Rules. These limits are designed to provide reasonable protection against harmful interference in a residential installation. This equipment generates, uses and can radiate radio frequency energy and, if not installed and used in accordance with the instructions, may cause harmful interference to radio communications. However, there is no guarantee that interference will not occur in a particular installation. If this equipment does cause harmful interference to radio or television reception, which can be determined by turning the equipment off and on, the user is encouraged to try to correct the interference by one or more of the following measures:

1. Reorient or relocate the receiving antenna.
2. Increase the separation between the equipment and receiver.
3. Connect the equipment into an outlet on a circuit different from that to which the receiver is connected.
4. Consult the dealer or an experienced radio/TV technician for help.

WEEE Warning



To avoid the potential effects on the environment and human health as a result of the presence of hazardous substances in electrical and electronic equipment, end users of electrical and electronic equipment should understand the meaning of the crossed-out wheeled bin symbol. Do not dispose of WEEE as unsorted municipal waste and have to collect such WEEE separately.

Customer Feedback

We are striving to improve our documentation quality and we appreciate your feedback. Email your opinions and comments to DocsFeedback@yealink.com.

About This Guide

Thank you for choosing the Yealink color-screen expansion module EXP50. The EXP50 is designed to improve the power and the flexibility of the advanced Yealink SIP-T52S, SIP-T54S, SIP-T56A, SIP-T58A and SIP-T58V media IP phones. It features a large graphic color LCD screen. Each EXP50 color-screen expansion module provides 20 physical keys with dual-color LEDs and three display pages, supporting a total of 60 keys. Up to three color-screen expansion modules can be daisy-chained to a single SIP-T52S/T54S/T56A/T58A/T58V host phone, offering a maximum of 180 Ext keys per phone.

The Yealink EXP50 is ideal for receptionists, administrative assistants, call center agents, power-users, and executives who need to monitor and manage a large volume of calls on a regular basis.

This guide provides everything you need to quickly set up and use the EXP50 color-screen expansion module. Be sure to read the Packaging Contents in this guide before you set up and use your color-screen expansion module. This guide takes the working together of the Yealink SIP-T54S IP phone running firmware version 81 and the Yealink EXP50 color-screen expansion module as an example for reference.

In This Guide

The topics provided in this guide include:

- Chapter 1 [Getting Started](#)
- Chapter 2 [Customizing the Yealink EXP50 Color-screen Expansion Module](#)
- Chapter 3 [Configuring the Yealink EXP50 Color-screen Expansion Module](#)
- Chapter 4 [Using the Yealink EXP50 Color-screen Expansion Module](#)

Table of Contents

About This Guide	v
In This Guide	v
Table of Contents	vii
Getting Started	1
Packaging Contents	1
Physical Features	3
Icon Instructions	4
LED Instructions	8
Installation	9
Startup	12
Customizing the Yealink EXP50 Color-screen Expansion Module	13
Wallpaper	13
Uploading the Custom Pictures	13
Deleting the Custom Pictures	14
Changing the Wallpaper	15
Power Saving	19
Enabling the Power Saving via Web User Interface	20
Configuring the Office Hour via Web User Interface	20
Configuring the Idle Timeout via Web User Interface	21
Adjusting the Backlight	22
Configuring the Yealink EXP50 Color-screen Expansion Module	25
Line	26
Speed Dial	27
Busy Lamp Field (BLF)	28
Voice Mail	30
Direct Pickup	31
Group Pickup	32
Call Park	33
Intercom	34
DTMF	35
Prefix	36
Local Group	37
XML Group	38
XML Browser	39
LDAP	40
Conference	41
Forward	42
Transfer	43
Hold	44
DND	45
ReCall	46

SMS.....	47
Record	48
URL Record.....	49
Multicast Paging	50
Group Listening	51
Private Hold.....	52
Hot Desking	53
ACD.....	54
Zero Touch	55
URL	56
Phone Lock.....	57
Retrieve Park	58
Directory.....	59
Using the Yealink EXP50 Color-screen Expansion Module.....	61
Using the Line Key	61
Using the Busy Lamp Field	62
Resetting the Yealink EXP50 Color-screen Expansion Module	62

Getting Started

This chapter provides basic installation instructions and information for obtaining the best performance with the EXP50 color-screen expansion module. The topics include:

- [Packaging Contents](#)
- [Physical Features](#)
- [Icon Instructions](#)
- [LED Instructions](#)
- [Installation](#)
- [Startup](#)

Packaging Contents

The following items are included in your package:

- **Expansion Module**

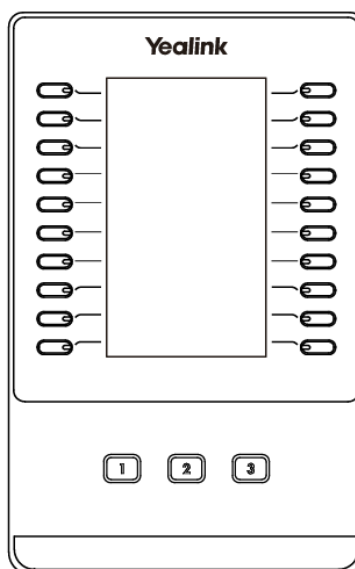

- **Stand**

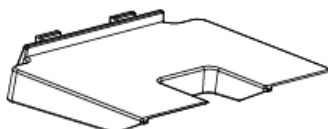

- **Connecting Sheet**

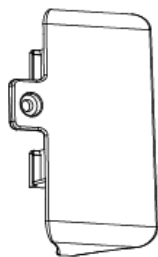

- **USB Cable (USB 2.0)**



- **One Screw**



- **Screwdriver**

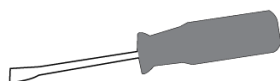

- **Quick Start Guide**



Check the list before installation. If you find anything missing, contact your reseller.

Physical Features

The main physical features of the EXP50 color-screen expansion module are color LCD screen, Ext keys, LED indicators, USB jack, Mini USB jack and power interface.

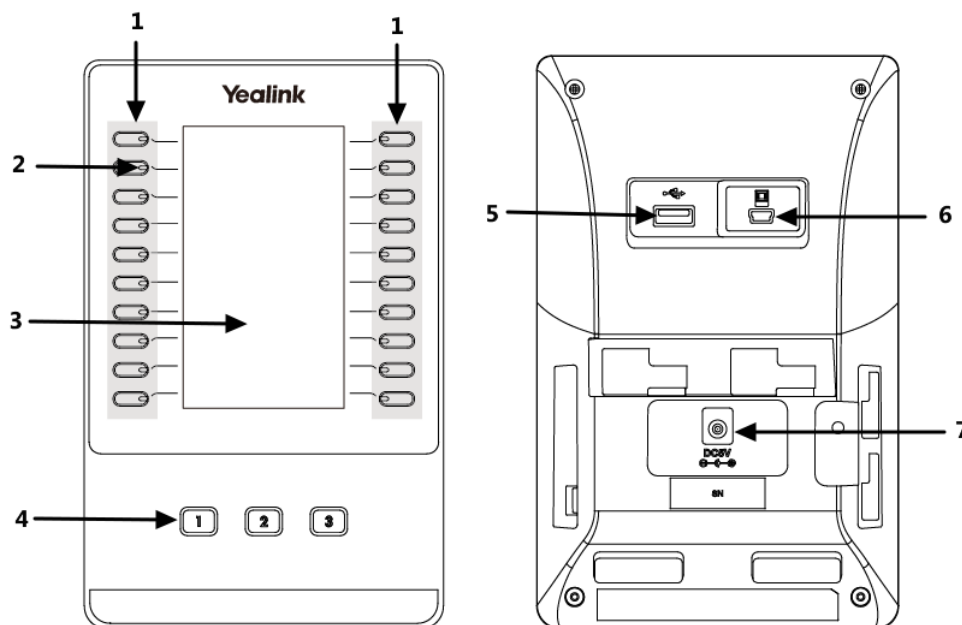























The main physical features of the EXP50 color-screen expansion module are described as below:

	Item	Description
①	Ext Keys	Assign various features to these keys.
②	LED Indicators	Indicate the Ext key status. For more information, refer to LED Instructions on page 8.
③	Color LCD Screen	Shows key feature label and key feature icon. For more information, refer to Icon Instructions on page 4.
④	Page Keys	Press these keys to navigate to corresponding page to view additional keys.
⑤	USB Jack	<ul style="list-style-type: none"> Connects the supplied cable to the Mini USB jack on the next expansion module. Connects the Wi-Fi USB dongle WF40, USB headset or USB flash drive.
⑥	Mini Jack	Connects the supplied cable to the USB jack on the host phone or to the USB jack on the prior expansion module.
⑦	Power Interface	Connects a power adapter to the expansion module. When more than two expansion modules are connected to a single host phone, you need to connect a power adapter to any one of the expansion modules.







Icon Instructions

Icon indicator (associated with line key features)





Icons	Description
	Hold Private Hold
	DND
	Voice Mail
	SMS
	Direct Pickup
	Group Pickup
	DTMF Prefix
	Local Group XML Group LDAP
	XML Browser
	Conference
	Forward
	Transfer
	ReCall
	Record URL Record
	Recording starts successfully (Record/URL Record)
	Multicast Paging Group Listening Paging List
	Hot Desking
	Zero Touch

Icons	Description
	URL
	Phone Lock
	Directory
	Speed Dial

Icon indicator (associated with line)





Icons	Description
	The private line registers successfully
	The shared/bridged line registers successfully
	Registering
	Register failed
	DND is enabled on this line
	Call forward is enabled on this line

Icon indicator (associated with call park/retrieve park)





Icons	Description
	Call Park (Park successfully; Call park idle state)
	Call Park (Park failed)
	Call Park (Call park ringing state)
	Retrieve Park

Icon indicator (associated with ACD)







Icon	Description
	Logged in the ACD system

Icon	Description
	The ACD status is available
	The ACD state is Wrap up
	The ACD status is unavailable
	Logged out of the ACD system

Icon indicator (associated with intercom)











Icons	Description
	Intercom idle state
	Intercom ringing state
	Intercom callout/talking state
	Intercom failed state

Icon indicator (associated with BLF/BLF List)

Icons	Description
	BLF/BLF List idle state
	BLF/BLF list ringing state
	BLF/BLF list callout state
	BLF/BLF list talking state
	BLF hold state
	BLF list call park state
	BLF/BLF List failed state







Icon indicator (associated with a shared line)

The local SCA phone indicates the phone is involved in an SCA call, while the monitoring SCA phone indicates the phone is not involved in the SCA call.

Icon	Description
	The shared line is idle.
 (for monitoring SCA phone)	The shared line is seized.
	The shared line receives an incoming call.
	The shared line is dialing.
	The shared line is in conversation.
	The shared line conversation is placed on public hold.
 (for local SCA phone)  (for monitoring SCA phone)	The shared line conversation is placed on private hold.
	The shared line conversation is barged in by the other shared line party.
	For a multi-party call, all the shared line parties participating in this call place the shared line conversation on hold.

Icon indicator (associated with a bridged line)

The local BLA phone indicates the phone is involved in a BLA call, while the monitoring BLA phone indicates the phone is not involved in the BLA call.

Icon	Description
	The bridged line is idle.
 (for monitoring BLA phone)	The bridged line is seized.
	The bridged line receives an incoming call.
	The bridged line is dialing.
	The bridged line is in conversation.
	The bridged line conversation is placed on hold.

LED Instructions

Page key LED

LED Status	Description
Solid green	Current page.
Off	Non-current page.
Fast-flashing Red	The BLF monitored user receives an incoming call on the non-current page.

Ext key LED (configured as a line key)

LED Status	Description
Solid green	The line is in conversation. The line is seized.
Fast-flashing green	The line receives an incoming call.
Slow-flashing green	The call is placed on hold.
Off	The line is inactive.

Ext key LED (configured as a BLF key)

LED Status	Description
Solid green	The monitored user is idle.
Fast-flashing red	The monitored user receives an incoming call.
Solid red	The monitored user is talking. The monitored user's conversation is placed on hold. The monitored user is dialing. The call is parked against the monitored user's phone number.
Off	The monitored user does not exist.

Installation

The EXP50 color-screen expansion module applies to Yealink T52S/T54S/T56A/T58A/T58V media IP phones. To easily connect the EXP50 to the phone, please unplug the phone stand from the IP phone.

Note

Up to three expansion modules can be connected to a media IP phone.

To unplug the stand from the IP phone:

1. Unplug the power adapter and Ethernet cable from the IP phone.
2. Unplug the handset attached to the IP phone.
3. Turn the IP phone over and lay it on a non-slip, flat surface.
4. Unplug the stand from the IP phone.

To connect the EXP50 color-screen expansion module:

1. Turn over the phone and expansion module, and lay them on a flat, non-flat, non-slip surface.
2. (Optional.) The slots of IP phone may be plugged up by silica gel. You can pull out the silica gel.

3. Connect the EXP50 color-screen expansion module and the IP phone using the supplied connecting sheet and screw.

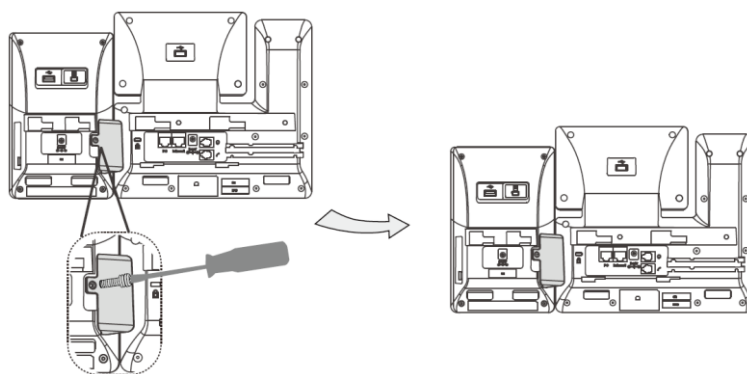

If you want to connect two or more expansion modules, pull out the silica gel and connect two expansion modules as below.

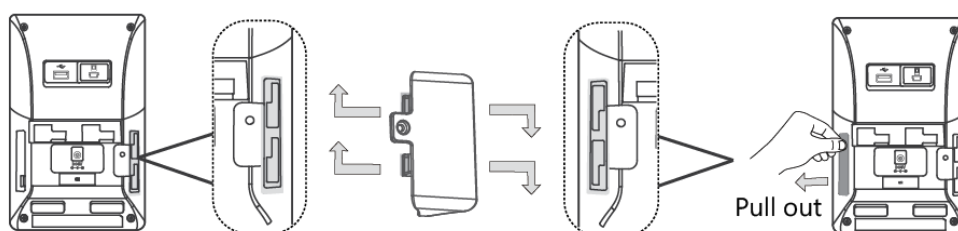

Connecting two expansion modules on a single host phone is shown as below:

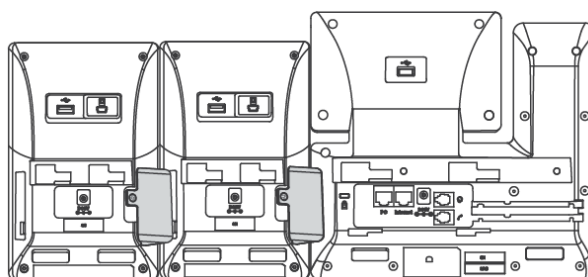

4. Connect the USB jack on the host phone and the mini USB jack on the expansion module using one supplied cable.

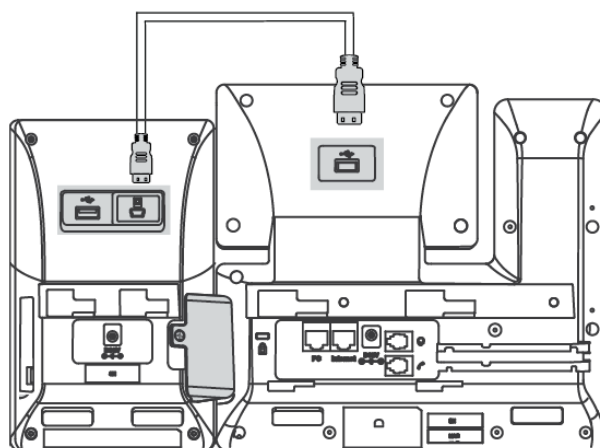

If you connect two expansion modules, connect the USB jack on the prior expansion module and the mini USB jack on the next expansion module using another supplied cable. Connecting two expansion modules on a single host phone is shown as below:

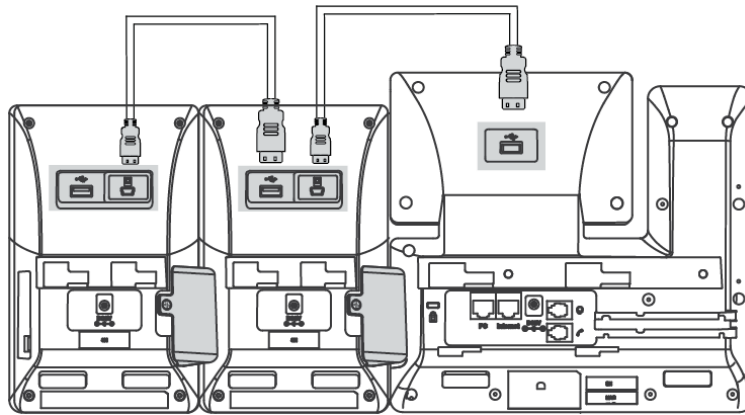
**Note**

Power is automatically transferred from the host phone to the expansion module(s) upon connection. If you want to use more than one expansion modules on a single phone, you need to connect an additional Yealink power adapter (5V/2A) to any one of the expansion modules.

The power adapter should be purchase separately.

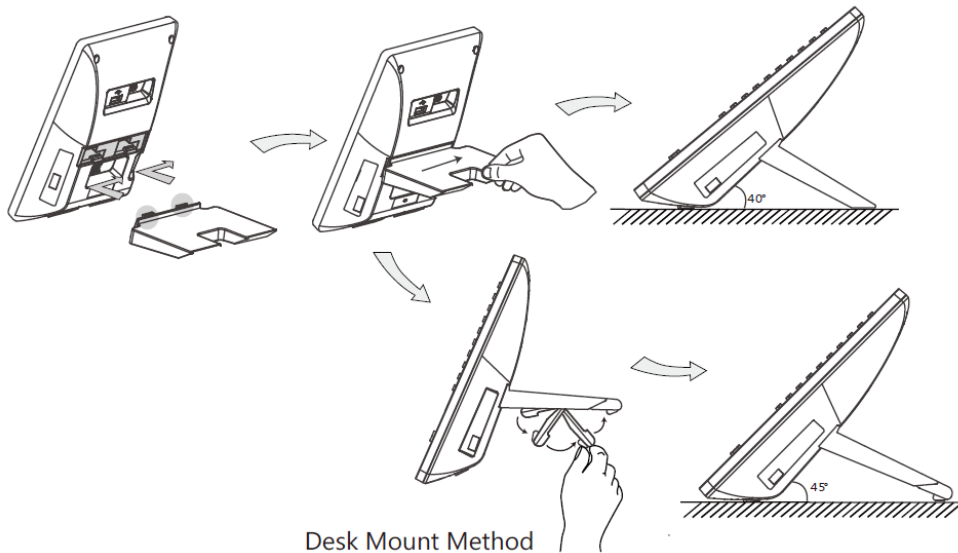
To attach the stand of the expansion module:

Startup

After the EXP50 color-screen expansion module is powered on, the LCD screen of the EXP50 color-screen expansion module will display "Welcome Loading...Please wait".

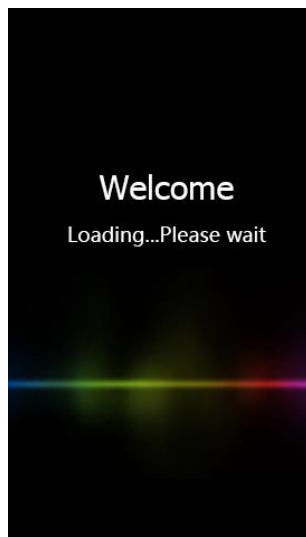

After a short time, the loading screen will disappear, and then you can assign the desired feature to the EXP50 color-screen expansion module.

Customizing the Yealink EXP50 Color-screen Expansion Module

You can customize EXP50 color-screen expansion module by personally configuring certain settings.

This chapter provides basic operating instructions for customizing EXP50 color-screen expansion module. Topics include:

- [Wallpaper](#)
- [Screen Saver](#)
- [Power Saving](#)
- [Adjusting the Backlight](#)

Wallpaper

You can customize the wallpaper expansion module EXP50 when connected to the media IP phone. The wallpaper can be changed via host phone user interface or web user interface. You can use a picture that is stored on your USB flash drives as wallpaper on your phone. When you set one of your pictures as the wallpaper, the picture will display on the wallpaper list. You can only upload custom pictures as wallpaper images via web user interface.

Uploading the Custom Pictures

The color-screen expansion module EXP50 supports the file format of pictures in the following table:

Format	Resolution	File Size
.jpg/.png/*.bmp/*.jpeg	≤4.2 megapixels	2MB of space should be reserved for the phone

You can upload the custom picture via web user interface.

To upload the custom picture via web user interface:

1. Click on **Settings->Preference**.

- In the **Upload Wallpaper(480*272)** field, click **Browse** to select the desired picture from your local system.

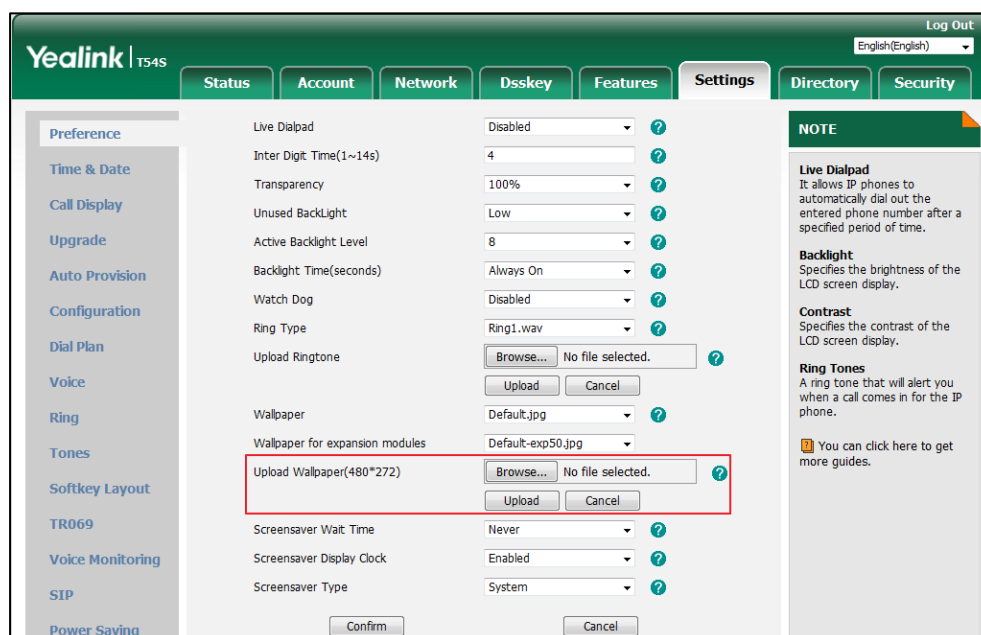



- Click **Upload** to upload the file.

The uploaded custom picture will apply to media IP phone and expansion module EXP50, and appears in the pull-down lists of **Wallpaper** and **Wallpaper for expansion modules** synchronously.

Deleting the Custom Pictures

You can delete the custom wallpaper via phone user interface or via web user interface.

To delete the custom picture via phone user interface:

- Press **Menu->Basic->Display->EXP Wallpaper**.
- Press  or , or the **Switch** soft key to select the desired picture.



- Press the **Delete** soft key to delete the corresponding picture.
The LCD screen prompts "Delete selected images?".
- Press the **OK** soft key to accept the change.

You can also delete the custom wallpaper by clicking **Del** when selecting the desired custom wallpaper in the **Wallpaper** or **Wallpaper for expansion modules** field. As shown below:

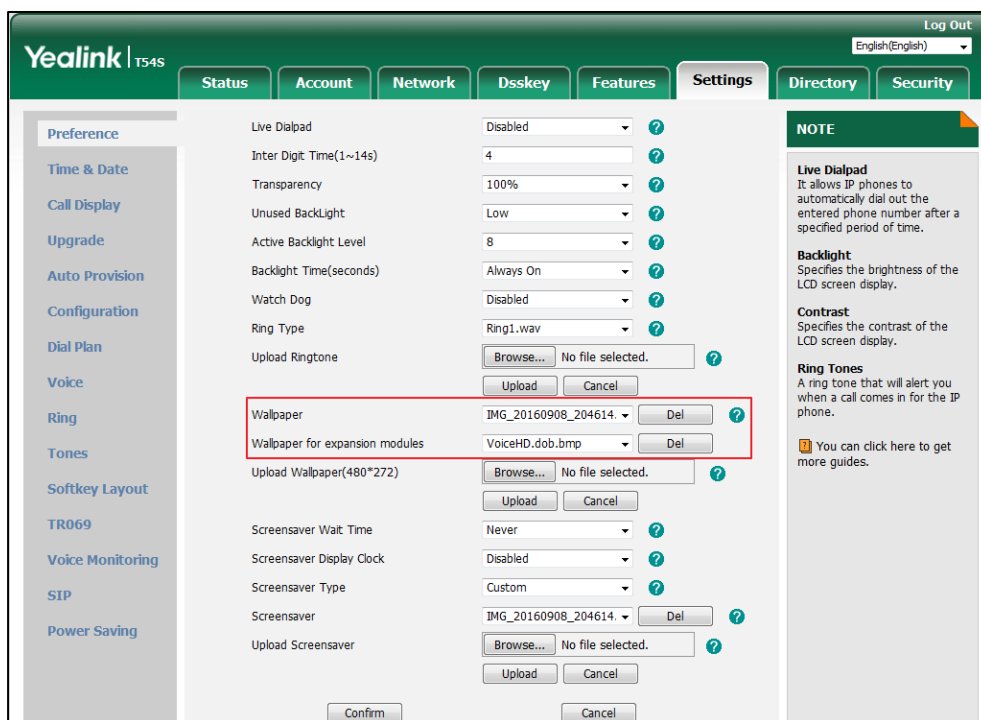

The custom wallpaper will disappear from the pull-down lists of **Wallpaper** and **Wallpaper for expansion modules** synchronously.

Changing the Wallpaper

You can change the wallpaper via phone user interface or web user interface.

To change the EXP wallpaper via phone user interface:

1. Press **Menu**->**Basic**->**Display**->**EXP Wallpaper**.
2. Press or , or the **Switch** soft key to select the desired wallpaper image.



3. Press the **Save** soft key to accept the change or the **Back** soft key to cancel.

If the wallpaper from the USB flash drive has been uploaded, you can change the desired wallpaper directly. Or you can set the custom wallpaper from the USB flash drive directly.

To add the custom picture from a USB flash drive via phone user interface:

1. Press **Menu->Record->Browse Photo**.
2. Press ◀ or ▶, or the **Switch** soft key to select the desired picture.
3. Press the **Preview** soft key.
4. Press the **Set as** soft key, and then select **Set as EXP wallpaper**.



5. Press the **OK** soft key to accept the change.

The EXP wallpaper will change to the corresponding picture.

Note

Before uploading the custom picture from the USB flash drive, please make sure that the USB flash drive has been connected to expansion module EXP50 successfully, and the picture is stored in the root folder on the USB flash drive and not stored in a specific folder.

Wallpaper for expansion modules is configurable via web user interface at the path **Settings->Preference**.

Note

The EXP50 color-screen expansion module screen size is 4.3 inches (Resolution: 272x480). If the size of the custom wallpaper doesn't meet the IP phone screen size, the wallpaper will be stretched or zoomed out according to the screen size.

For more information on wallpaper, refer to the *Wallpaper* section of [Yealink phone-specific user guide](#).

Screen Saver

The screen saver will automatically start when the IP phone is idle for the preset waiting time. The screen saver is used to blank the screen or fill it with moving images or patterns. If you connect a color-screen expansion module EXP50 to the IP phone, the screensaver will start or stop on the phone and EXP50 synchronously.

The screen saver will be stopped if one of the following phone events occurs:

- Press any key.
- Pick up/hang up the handset.
- There is an incoming call.
- A new prompt (e.g., missed call, new voice mail or forwarded call).
- The status of BLF key changes.

If your phone and EXP50 is idle again for a specified period of time, the screen saver will start again. The time & date and certain feature status icons (e.g., a new text message, auto answer, DND) will also display on the screen saver. For more information on the icons, refer to [Icon Instructions](#) on page 4. You can configure the phone whether to display the time & date on the screen saver or not.

You can configure the screen saver of SIP-T54S media IP phone, and upload custom pictures to set up a screen saver of your picture via web user interface. You can configure the screen saver wait time, screen saver type and screen saver display clock via phone user interface or web user interface.

Uploading the Custom Picture

The SIP-T54S media IP phone supports the file format of custom pictures in the following table:

Format	Resolution	File Size
.jpg/.png/*.bmp/*.jpeg	≤4.2 megapixels	2MB of space should be reserved for the phone

To upload a custom picture via web user interface:

1. Click on **Settings**->**Preference**.
2. Select **Custom** from the pull-down list of **Screensaver** Type.
3. In the **Upload Screensaver** field, click **Browse** to locate the custom picture from your local system, and then click **Upload**.

This field appears only if **Screensaver Type** is set to **Custom**.

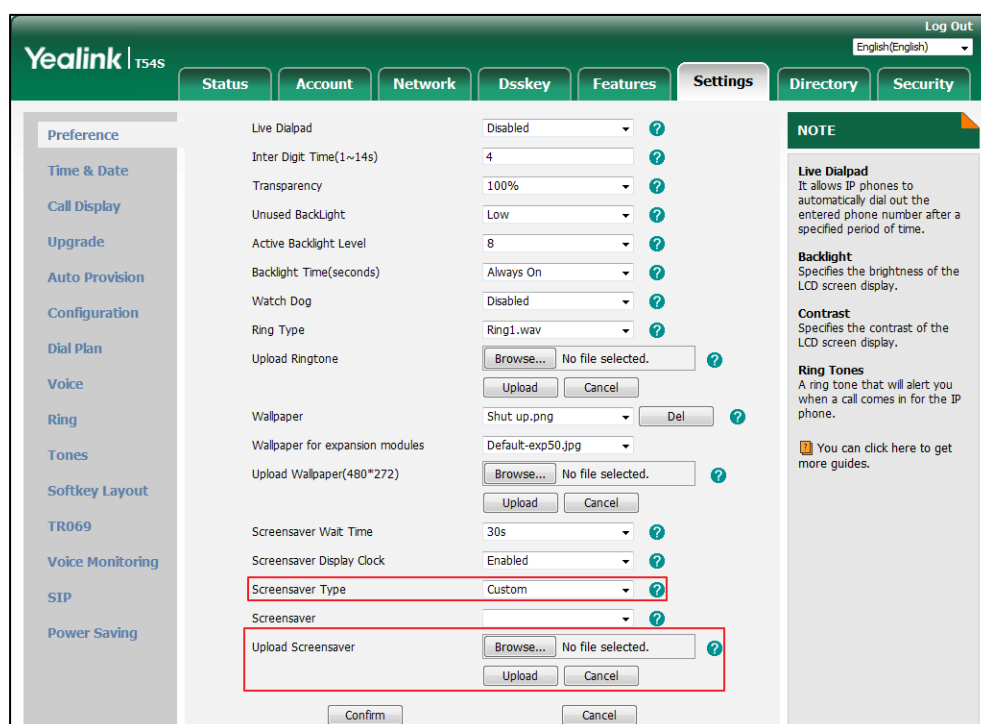

The custom picture appears in **Screensaver** list. You can only delete the custom picture by clicking **Del** when the desired custom picture is selected in the **Screensaver** field.

To upload a custom picture from USB flash drive via phone user interface:

1. Press **Menu**->**USB Record**->**Browse Photo**.
2. Press **▲** or **▼** , or the **Switch** soft key to select the desired picture.
3. Press the **Preview** soft key.
4. Press the **Set as** soft key, and then select **Set as screensaver**.



5. Press the **OK** soft key to accept the change.

Note

Before uploading the custom picture from the USB flash drive, please make sure that the USB flash drive has been connected successfully, and the picture is stored in the root folder on the USB flash drive and not stored in a specific folder.

Configuring the Screen Saver

To configure the screen saver via phone user interface:

1. Press **Menu**->**Basic**->**Display**->**Screensaver**.
2. Press ◀ or ▶, or the **Switch** soft key to select the desired wait time from the **Wait Time** field.
3. Press ◀ or ▶, or the **Switch** soft key to select the desired value from the **Display Clock** field.
4. Press ◀ or ▶, or the **Switch** soft key to select the desired screen saver type from the **Screensaver Type** field.

This field is configurable only if you have uploaded a custom picture via web user interface.

- If you select **System**.
The IP phone will automatically set the built-in picture as the screen saver.
- If you select **Custom**.
The IP phone will automatically set the custom pictures you upload as the screen saver, and display these pictures alternately.

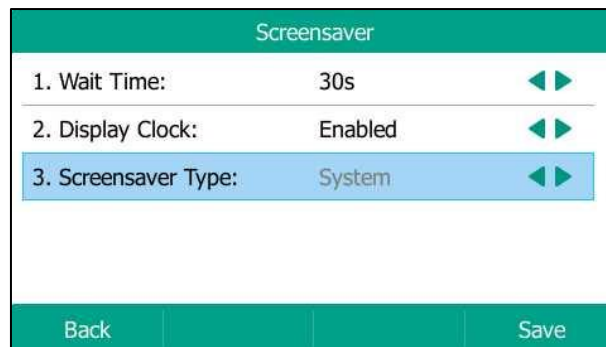

5. Press the **Save** soft key to accept the change or the **Back** soft key to cancel.

Screen Saver is configurable via web user interface at the path **Settings**->**Preference**.

Power Saving

The power saving feature is used to turn off the backlight and screen to conserve energy. The EXP50 color-screen expansion module enters power-saving mode after it has been idle for a certain period of time.

The EXP50 color-screen expansion module will exit power-saving mode if one of the following phone events occurs:

- Press any key on the host phone or EXP50.
- Pick up/hang up the handset on the host phone.

- There is an incoming call.
- A new prompt (e.g., missed call, new voice mail or forwarded call) on the host phone.
- The status of BLF key changes.

You can configure the following power-saving settings:

- Office Hour
- Idle Timeout (minutes)

The office hour and idle timeout (minutes) settings work only if the power saving feature is enabled.

Note Power saving is configurable via web user interface only.

Enabling the Power Saving

To enable the power saving feature via web user interface:

1. Click on **Settings->Power Saving**.
2. Select **Enabled** from the pull-down list of **Power Saving**.

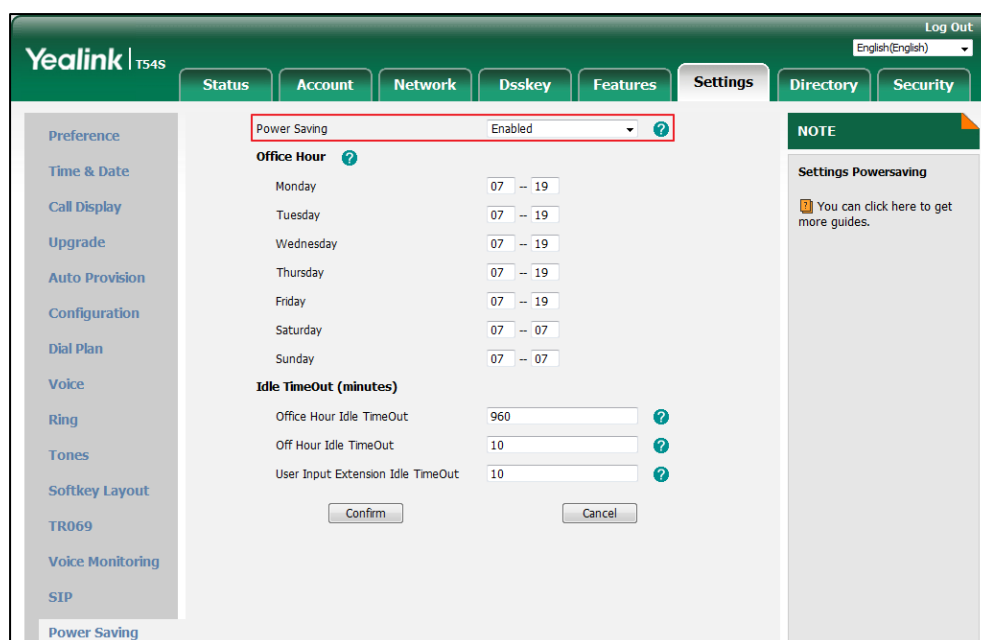

3. Click **Confirm** to accept the change.

Configuring the Office Hour

Office Hour specifies the starting time and ending time in the office each day.

To configure the office hour via web user interface:

1. Click on **Settings**->**Power Saving**.
2. Enter the starting time and ending time respectively in the desired day field.

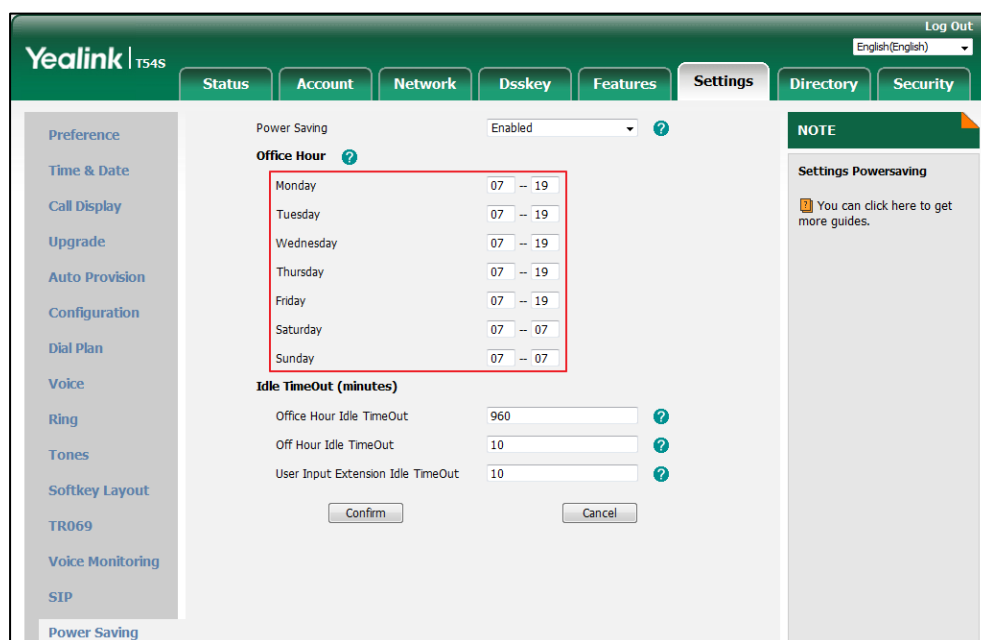

3. Click **Confirm** to accept the change.

Configuring the Idle Timeout

Idle Timeout specifies the period of time before the IP phone enters power-saving mode. The following three types of idle timeout you can configure:

- **Office Hours Idle TimeOut:** Configures the idle timeout for office hours.
- **Off Hours Idle TimeOut:** Configures the idle timeout for non-office hours.
- **User Input Extension Idle TimeOut:** Configures idle timeout that applies after you use the IP phone (for example, press a key on the phone or pick up/hang up the handset).

By default, the Office Hours Idle TimeOut is much longer than the Off Hours Idle TimeOut. If you use the IP phone, the idle timeout that applies (User Input Extension Idle TimeOut or Office Hours/Off Hours Idle TimeOut) is the timeout with the highest value. If the phone has an incoming call or new message, the User Input Extension Idle TimeOut is ignored.

To configure the idle timeout via web user interface:

1. Click on **Settings**->**Power Saving**.
2. Enter the desired value in the **Office Hours Idle TimeOut** field.
The default value is 960 can set to 1-960.
3. Enter the desired value in the **Off Hours Idle TimeOut** field.
The default value is 10, you can set to 1-10.

- Enter the desired value in the **User Input Extension Idle TimeOut** field.
The default value is 10, you can set to 1-30.

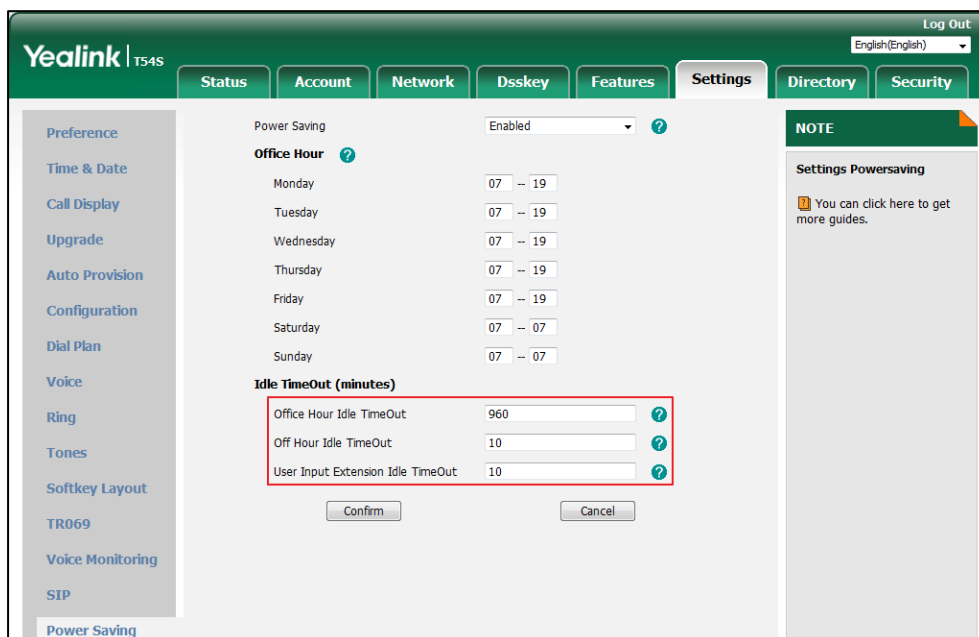

- Click **Confirm** to accept the change.

For more information on power saving, refer to the *Power Saving* section of [Yealink phone-specific user guide](#).



Adjusting the Backlight

You can adjust the backlight level on the LCD screen of the EXP50 color-screen expansion module via the host phone. The backlight level on the LCD screen of the EXP50 color-screen expansion module is synchronized with that of the host phone.

To adjust the backlight via phone user interface:

- Press **Menu->Basic->Display->Backlight** on the host phone.



- Press  or , or the **Switch** soft key to select the desired level from the **Active Level** field on the host phone.

3. Press the **Save** soft key to accept the change or the **Back** soft key to cancel on the host phone.

For more information on adjusting the backlight on the phone, refer to the *Backlight* section of [Yealink phone-specific user guide](#).

Configuring the Yealink EXP50 Color-screen Expansion Module

The EXP50 color-screen expansion module supports 60 Ext keys. You can access the 60 Ext keys via three page keys. Each key can be assigned a feature using the configuration files, via phone user interface or web user interface. For more information on using the configuration files to assign a feature, refer to [Yealink Auto Provisioning Guide](#).

Phone User Interface

Long press the desired key, the phone will enter the setting screen of this key.

Web User Interface

To log into the web user interface, you should obtain the IP address of the host phone in advance. Press the OK key when the phone is idle, and the host phone will display the IP address and some other information. Enter the IP address (e.g., <http://192.168.0.10> or 192.168.0.10) in the address bar of the web browser on your PC. The default user name and password are both "admin" (case-sensitive).

This chapter provides you with instructions of assigning a feature to an Ext key via web user interface. The topics include:

- [Line](#)
- [Speed Dial](#)
- [Busy Lamp Field \(BLF\)](#)
- [Busy Lamp Field \(BLF\) List](#)
- [Voice Mail](#)
- [Direct Pickup](#)
- [Group Pickup](#)
- [Call Park](#)
- [Intercom](#)
- [DTMF](#)
- [Prefix](#)
- [Local Group](#)
- [XML Group](#)
- [XML Browser](#)
- [LDAP](#)
- [Conference](#)

- [Forward](#)
- [Transfer](#)
- [Hold](#)
- [DND](#)
- [ReCall](#)
- [SMS](#)
- [Record](#)
- [URL Record](#)
- [Multicast Paging](#)
- [Group Listening](#)
- [Private Hold](#)
- [Hot Desking](#)
- [ACD](#)
- [Zero Touch](#)
- [URL](#)
- [Phone Lock](#)
- [Retrieve Park](#)
- [Directory](#)

Note

Quick access features like intercom and voice mail should be configured on your SIP server in advance to make sure they will work on your phone. Contact your system administrator for more information.

If more than one expansion module is connected, select the desired expansion module from the pull-down list of **Expansion Key**.

Feature codes may vary between different servers.

The available key features may vary between different phone firmware versions. This guide introduces key features available on the SIP-T54S IP phone running firmware version 81 or later.

Line

You can configure an Ext key as the line key. You can press this key to enter the pre-dialing screen when the phone is idle. You can also press this key to place a new call during an active call, and then the original call is placed on hold. For more information on using the line key, refer to [Using the Line Key](#) on page 61.

To configure an Ext key as the line key:

1. Click on **Dsskey->Ext Key**.
2. In the desired Ext key field, select **Line** from the pull-down list of **Type**.
3. Enter the desired value in the **Label** field or leave it blank.
If you leave this field blank, the LCD screen of the EXP50 color-screen expansion module will display the number specified in the **Value** field.
4. Select the desired line to apply this key from the pull-down list of **Line**.

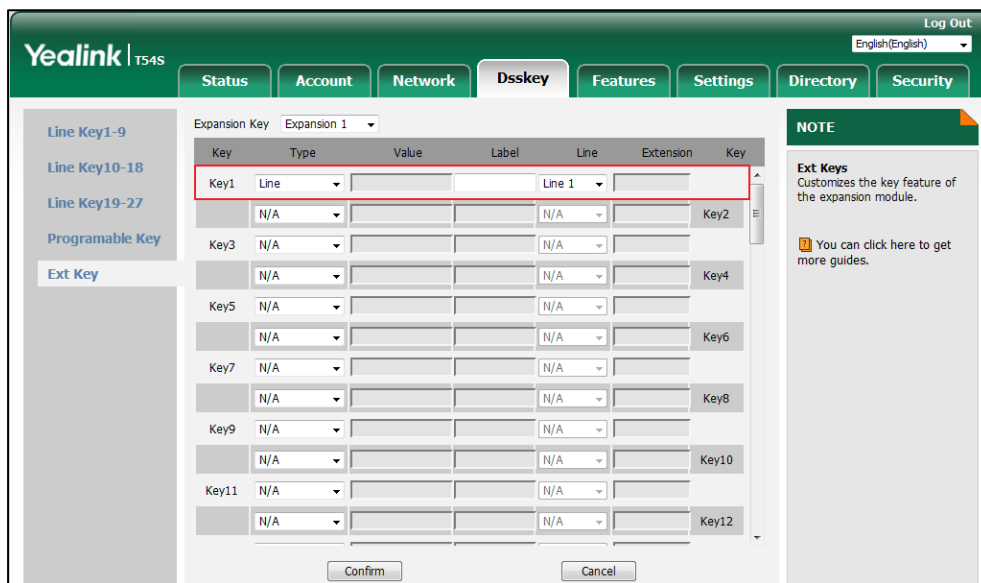

5. Click **Confirm** to accept the change.

Speed Dial

You can configure an Ext key as the speed dial key. Then you can quickly dial out the pre-defined number using the specified line by pressing the speed dial key.

To configure an Ext key as the speed dial key:

1. Click on **Dsskey->Ext Key**.
2. In the desired Ext key field, select **SpeedDial** from the pull-down list of **Type**.
3. Enter the desired number you want to dial out directly in the **Value** field (e.g., 1003).
4. Enter the desired value in the **Label** field or leave it blank.

If you leave this field blank, the LCD screen of the EXP50 color-screen expansion module will display the number specified in the **Value** field.

- Select the desired line to apply this key from the pull-down list of **Line**.

The screenshot shows the Yealink T54S web interface with the 'Dsskey' tab selected. The 'Expansion Key' is set to 'Expansion 1'. A table of keys is displayed with the following columns: Key, Type, Value, Label, Line, Extension, and Key. Key1 is highlighted with a red box and has 'Speed Dial' selected in the 'Type' dropdown, '1003' in the 'Value' field, and 'Line 1' selected in the 'Line' dropdown. Other keys (Key2 through Key12) have 'N/A' in the 'Type' dropdown. A 'NOTE' box on the right states: 'Ext Keys Customizes the key feature of the expansion module. You can click here to get more guides.'

Key	Type	Value	Label	Line	Extension	Key
Key1	Speed Dial	1003		Line 1		
	N/A			N/A		Key2
Key3	N/A			N/A		
	N/A			N/A		Key4
Key5	N/A			N/A		
	N/A			N/A		Key6
Key7	N/A			N/A		
	N/A			N/A		Key8
Key9	N/A			N/A		
	N/A			N/A		Key10
Key11	N/A			N/A		
	N/A			N/A		Key12

- Click **Confirm** to accept the change.

Busy Lamp Field (BLF)

Busy Lamp Field (BLF) allows you to monitor the status changes of a user. You can configure an Ext key as the BLF key, which allows you to monitor the status (idle, ringing or busy) of the pre-defined phone user. You can also pick up the incoming call of the monitored user directly by pressing the BLF key. For more information on using the Busy Lamp Field, refer to [Using the Busy Lamp Field](#) on page 62.

To configure an Ext key as the BLF key:

- Click on **Dsskey** -> **Ext Key**.
- In the desired Ext key field, select **BLF** from the pull-down list of **Type**.
- Enter the phone number you want to monitor in the **Value** field (e.g., 1001).
- Enter the desired value in the **Label** field or leave it blank.

If you leave this field blank, the LCD screen of the EXP50 color-screen expansion module will display the value specified in the **Value** field.

- Select the desired line to apply to this key from the pull-down list of **Line**.

- Enter the directed call pickup code in the **Extension** field (e.g., *30).

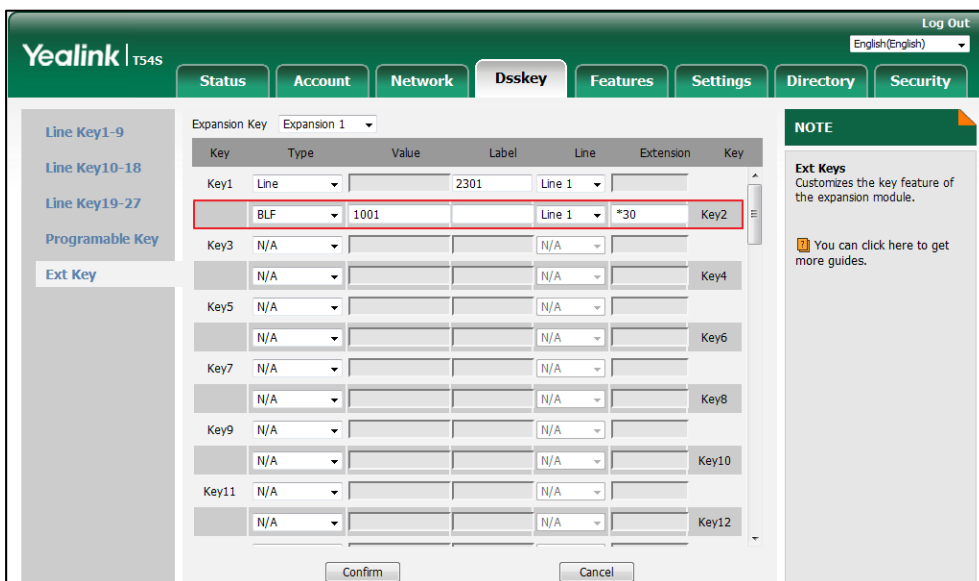

- Click **Confirm** to accept the change.

Busy Lamp Field (BLF) List

Busy Lamp Field (BLF) List allows you to monitor a list of users defined by your system administrator. For example, your system administrator enables BLF List, and creates a BLF List URI (e.g., BLFList@example.com) including a list of user1, user2 on the server. The BLF List keys on the IP phone can present the status of user1 and user2.

Note Before configuring a BLF list key, make sure auto BLF list feature is disabled on the phone. Contact your system administrator for more information.

To configure an Ext key as the BLF list key:

- Click on **Dsskey->Ext Key**.
- In the desired Ext key field, select **BLF List** from the pull-down list of **Type**.

3. Select the desired line to apply to this key from the pull-down list of **Line**.

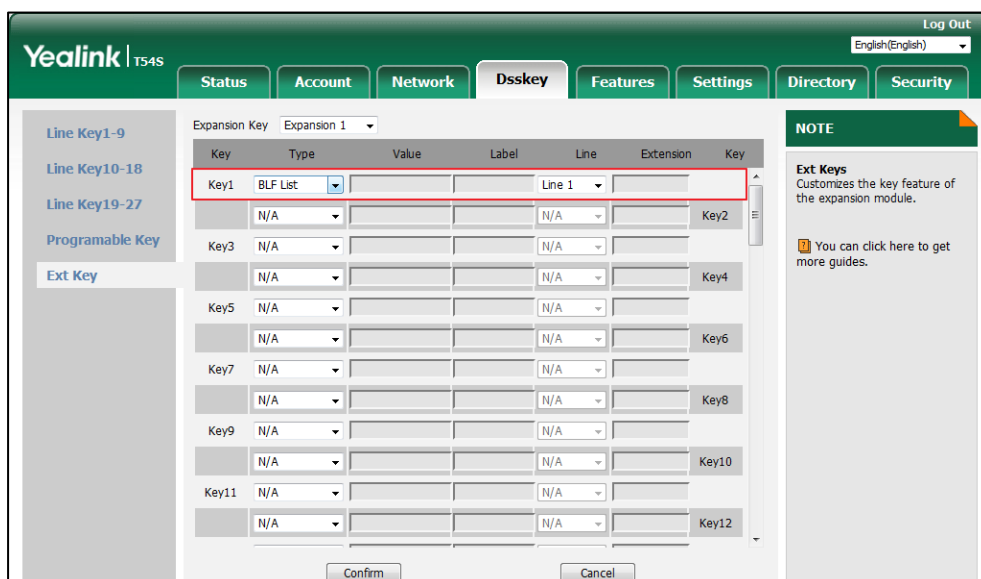

4. Click **Confirm** to accept the change.

Voice Mail

You can configure an Ext key as the voice mail key. Then you can press the voice mail key when the phone is idle to dial out the pre-defined voice mail access code, and follow the voice prompt to listen to the voice mails.

To configure an Ext key as the voice mail key:

1. Click on **Dsskey->Ext Key**.
2. In the desired Ext key field, select **Voice Mail** from the pull-down list of **Type**.
3. Enter the voice mail access code in the **Value** field (e.g., *4).
4. Enter the desired value in the **Label** field or leave it blank.

If you leave this field blank, the LCD screen of the EXP50 color-screen expansion module will display the default label "Voice Mail".

5. Select the desired line to apply this key from the pull-down list of **Line**.

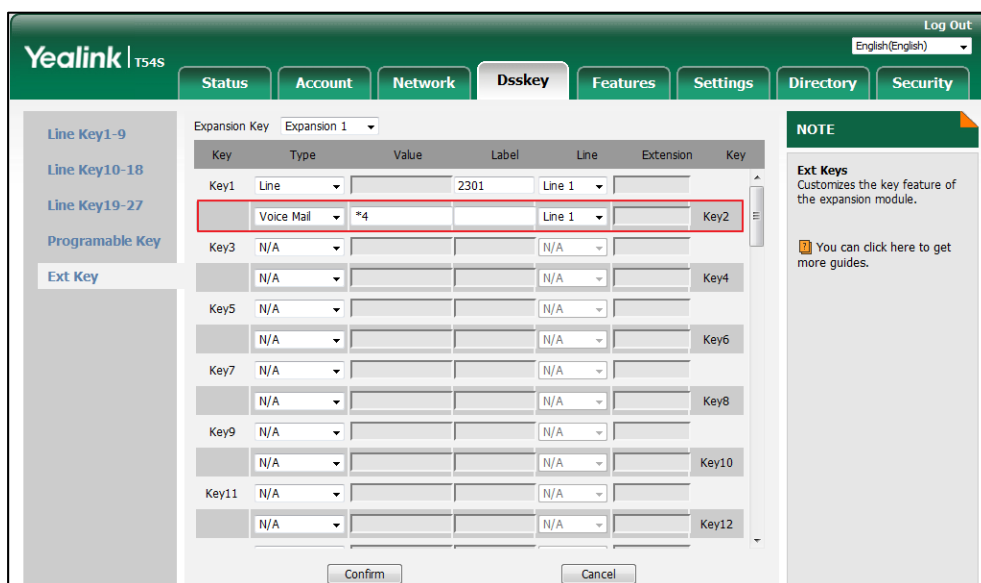

6. Click **Confirm** to accept the change.

Direct Pickup

You can configure an Ext key as the direct pickup key. If you press the direct pickup key when the specified phone number receives an incoming call, the call will be answered on your phone.

To configure an Ext key as the direct pickup key:

1. Click on **Dsskey**-> **Ext Key**.
2. In the desired Ext key field, select **Direct Pickup** from the pull-down list of **Type**.
3. Enter the directed call pickup code followed by the specific extension you want to pickup calls from in the **Value** field (e.g., *971003).
4. Enter the desired value in the **Label** field or leave it blank.

If you leave this field blank, the LCD screen of the EXP50 color-screen expansion module will display the default label "DPickup".

- Select the desired line to apply this key from the pull-down list of **Line**.

Key	Type	Value	Label	Line	Extension	Key
Key1	Line	2301		Line 1		
Key2	Direct Pickup	*971003		Line 1		Key2
Key3	N/A			N/A		
Key4	N/A			N/A		Key4
Key5	N/A			N/A		
Key6	N/A			N/A		Key6
Key7	N/A			N/A		
Key8	N/A			N/A		Key8
Key9	N/A			N/A		
Key10	N/A			N/A		Key10
Key11	N/A			N/A		
Key12	N/A			N/A		Key12

- Click **Confirm** to accept the change.

Group Pickup

Group pickup allows you to pick up incoming calls within a pre-defined group of phone numbers.

You can configure an Ext key as the group pickup key. When any number within the group receives an incoming call, you can press the group pickup key to pick up the incoming call. If the numbers within the group receive multiple incoming calls, the first incoming call will be picked up.

To configure an Ext key as the group pickup key:

- Click on **Dsskey** -> **Ext Key**.
- In the desired Ext key field, select **Group Pickup** from the pull-down list of **Type**.
- Enter the group call pickup code in the **Value** field (e.g., *98).
- Enter the desired value in the **Label** field or leave it blank.

If you leave this field blank, the LCD screen of the EXP50 color-screen expansion module will display the default label "GPickup".

- Select the desired line to apply this key from the pull-down list of **Line**.

The screenshot shows the Yealink T54S web interface with the 'Dsskey' tab selected. Under 'Expansion Key', a table lists keys from Key1 to Key12. Key 2 is highlighted with a red border. The table has columns for Key, Type, Value, Label, Line, Extension, and Key. Key 2 has 'Group Pickup' as Type, '*98' as Value, and 'Line 1' as Line. Other keys have 'N/A' for Type and Line. A 'NOTE' box on the right explains that 'Ext Keys' customize the key feature of the expansion module and provides a link to more guides.

Key	Type	Value	Label	Line	Extension	Key
Key1	Line	2301		Line 1		
Key2	Group Pickup	*98		Line 1		Key2
Key3	N/A			N/A		
Key4	N/A			N/A		Key4
Key5	N/A			N/A		
Key6	N/A			N/A		Key6
Key7	N/A			N/A		
Key8	N/A			N/A		Key8
Key9	N/A			N/A		
Key10	N/A			N/A		Key10
Key11	N/A			N/A		
Key12	N/A			N/A		Key12

- Click **Confirm** to accept the change.

Call Park

The call park feature allows you to park a call at a special extension and then retrieve it on any other phone in the system.

You can configure an Ext key as the call park key. Then you can park a call at an extension by pressing the call park key. The current call is placed on hold and can be retrieved on another IP phone.

To configure an Ext key as the call park key:

- Click on **Dsskey**-> **Ext Key**.
- In the desired Ext key field, select **Call Park** from the pull-down list of **Type**.
- Enter the call park feature code in the **Value** field (e.g., *68).
- Enter the desired value in the **Label** field or leave it blank.

If you leave this field blank, the LCD screen of the EXP50 color-screen expansion module will display the default label "Call Park".

- Select the desired line to apply this key from the pull-down list of **Line**.

Key	Type	Value	Label	Line	Extension	Key
Key1	Line	2301		Line 1		
Key2	Call Park	*68		Line 1		Key2
Key3	N/A			N/A		
Key4	N/A			N/A		Key4
Key5	N/A			N/A		
Key6	N/A			N/A		Key6
Key7	N/A			N/A		
Key8	N/A			N/A		Key8
Key9	N/A			N/A		
Key10	N/A			N/A		Key10
Key11	N/A			N/A		
Key12	N/A			N/A		Key12

- Click **Confirm** to accept the change.

Intercom

You can configure an Ext key as the intercom key. This is especially helpful in an office environment as you can connect to the operator or the secretary more quickly by pressing the intercom key.

To configure an Ext key as the intercom key:

- Click on **Dsskey->Ext Key**.
- In the desired Ext key field, select **Intercom** from the pull-down list of **Type**.
- Enter the remote extension number in the **Value** field (e.g., 1006).
- Enter the desired value in the **Label** field or leave it blank.

If you leave this field blank, the LCD screen of the EXP50 color-screen expansion module will display the default label "Intercom".

- Select the desired line to apply this key from the pull-down list of **Line**.
- Enter the directed call pickup code in the **Extension** field.

If it is configured, when the target extension receives an incoming call, the supervisor can press the intercom key to pick up the call directly. Contact your system administrator for more information.

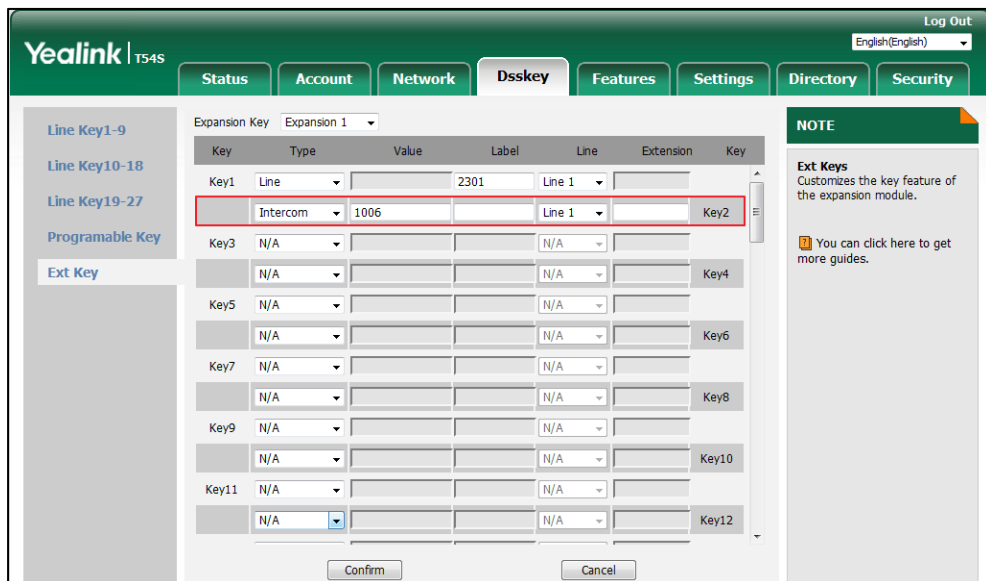

7. Click **Confirm** to accept the change.

DTMF

You can configure an Ext key as the DTMF key. If you press the DTMF key during an active call, the phone will send the pre-defined DTMF digits.

To configure an Ext key as the DTMF key:

1. Click on **Dsskey**->**Ext Key**.
2. In the desired Ext key field, select **DTMF** from the pull-down list of **Type**.
3. Enter the desired DTMF digits in the **Value** field (e.g., 123A).
4. Enter the desired value in the Label field or leave it blank.

If you leave this field blank, the LCD screen of the EXP50 color-screen expansion module will display the default label "DTMF".

Key	Type	Value	Label	Line	Extension	Key
Key1	Line	2301		Line 1		
Key2	DTMF	123A		N/A		Key2
Key3	N/A			N/A		
Key4	N/A			N/A		Key4
Key5	N/A			N/A		
Key6	N/A			N/A		Key6
Key7	N/A			N/A		
Key8	N/A			N/A		Key8
Key9	N/A			N/A		
Key10	N/A			N/A		Key10
Key11	N/A			N/A		
Key12	N/A			N/A		Key12

5. Click **Confirm** to accept the change.

Prefix

You can configure an Ext key as the prefix key. If you press the prefix key when the phone is idle, the phone will enter into the dialing screen and display the prefix number which you specified. You can enter other digits and then dial out.

To configure an Ext key as the prefix key:

1. Click on **Dsskey**->**Ext Key**.
2. In the desired Ext key field, select **Prefix** from the pull-down list of **Type**.
3. Enter the prefix number you want to add before the entered number in the **Value** field (e.g., 0592).
4. Enter the desired value in the **Label** field or leave it blank.

If you leave this field blank, the LCD screen of the EXP50 color-screen expansion module will display "Prefix: 'the value specified in the Value field' " (e.g., Prefix: 0592).

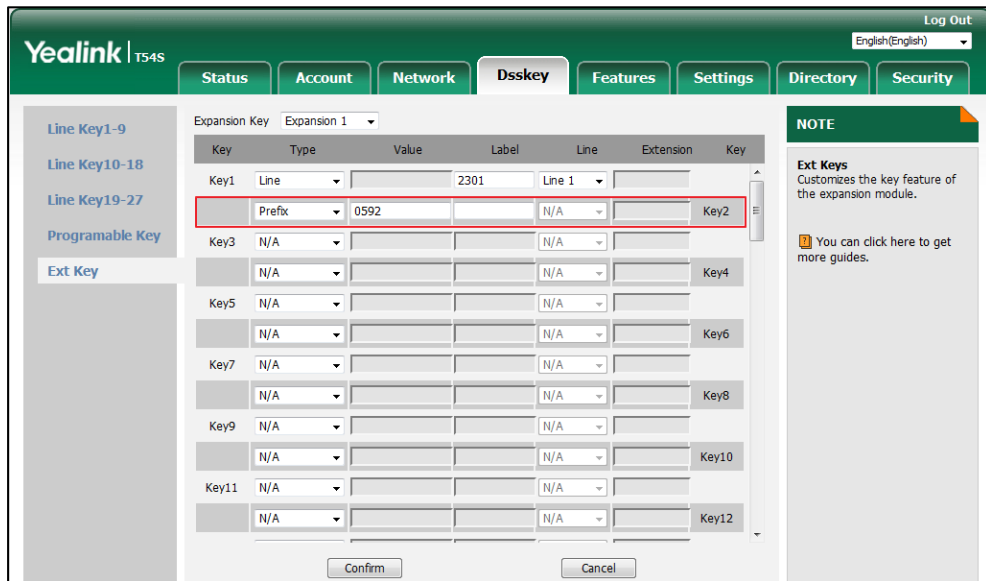

5. Click **Confirm** to accept the change.

Local Group

You can configure an Ext key as the local group key. Then you can press the local group key to access the pre-defined contact group in the local directory quickly.

To configure an Ext key as the local group key:

1. Click on **Dsskey**->**Ext Key**.
2. In the desired Ext key field, select **Local Group** from the pull-down list of **Type**.
3. Enter the desired value in the **Label** field or leave it blank.

If you leave this field blank, the LCD screen of the EXP50 color-screen expansion module will display the selected group name.

4. Select the desired contact group name from the pull-down list of **Line**.

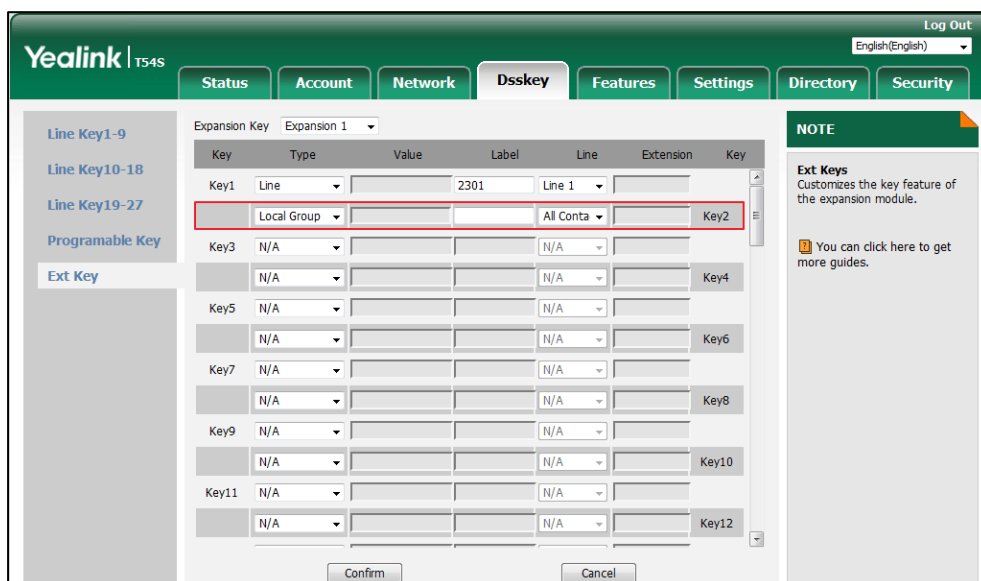

5. Click **Confirm** to accept the change.

XML Group

You can configure an Ext key as the XML group key. If you press the XML phonebook key when the phone is idle, the phone will automatically download the corresponding phone book from the server and display the entries of the phone book on the LCD screen of the phone. To use this key feature, you need to configure remote phonebook on the phone in advance.

To configure an Ext key as the XML group key:

1. Click on **Dsskey** -> **Ext Key**.
2. In the desired Ext key field, select **XML Group** from the pull-down list of **Type**.
3. Enter the desired value in the **Label** field or leave it blank.

If you leave this field blank, the LCD screen of the EXP50 color-screen expansion module will display the selected XML group name.

- Select the desired XML group name from the pull-down list of **Line**.

The screenshot shows the Yealink T54S web interface with the 'Dsskey' tab selected. The 'Expansion Key' is set to 'Expansion 1'. A table lists keys from Key1 to Key12. Key2 is highlighted with a red box, showing 'XML Group' in the 'Type' column, an empty 'Value' field, and 'N/A' in the 'Line' column. A 'NOTE' panel on the right explains that 'Ext Keys' customize key features.

Key	Type	Value	Label	Line	Extension	Key
Key1	Line	2301		Line 1		
	XML Group			N/A		Key2
Key3	N/A			N/A		
	N/A			N/A		Key4
Key5	N/A			N/A		
	N/A			N/A		Key6
Key7	N/A			N/A		
	N/A			N/A		Key8
Key9	N/A			N/A		
	N/A			N/A		Key10
Key11	N/A			N/A		
	N/A			N/A		Key12

- Click **Confirm** to accept the change.

XML Browser

XML browser is a simple browser feature, which is based on xml language and http/https service. Users can use tools such as PHP, JavaScript, etc., accordance with the established syntax, to generate server-side features dynamically to meet the needs of the user xml file, and then download the xml file to a SIP phone by http/https, so as to realize a simple browser feature. Using XML browser, users can achieve the personalized features, such as weather information, stock information, date of inquiry, access to address book, configuration of the terminal parameters and so on.

To configure an Ext key as the XML browser key:

- Click on **Dsskey**->**Ext Key**.
- In the desired Ext key field, select **XML Browser** from the pull-down list of **Type**.
- Enter the URL you want to set as the XML Browser in the **Value** field (e.g., `http://10.3.6.20/xmlBro.xml`).
- Enter the desired value in the **Label** field or leave it blank.

If you leave this field blank, the LCD screen of the EXP50 color-screen expansion module will display the default label "XML Browser".

The screenshot shows the Yealink T54S web interface with the 'Dsskey' tab selected. The 'Expansion Key' is set to 'Expansion 1'. A table lists 12 keys (Key1 to Key12) with columns for Key, Type, Value, Label, Line, Extension, and Key. Key2 is highlighted in red and has 'XML Browser' selected in the Type dropdown and 'http://10.3.6.20/' in the Value field. A 'NOTE' section on the right states: 'Ext Keys Customizes the key feature of the expansion module. You can click here to get more guides.' Buttons for 'Confirm' and 'Cancel' are at the bottom.

Key	Type	Value	Label	Line	Extension	Key
Key1	Line	2301		Line 1		
	XML Browser	http://10.3.6.20/		N/A		Key2
Key3	N/A			N/A		
	N/A			N/A		Key4
Key5	N/A			N/A		
	N/A			N/A		Key6
Key7	N/A			N/A		
	N/A			N/A		Key8
Key9	N/A			N/A		
	N/A			N/A		Key10
Key11	N/A			N/A		
	N/A			N/A		Key12

5. Click **Confirm** to accept the change.

LDAP

LDAP (Lightweight Directory Access Protocol) is an application protocol for accessing and maintaining information services of the distributed directory over an IP network. The IP phone can be configured to interface with a corporate directory server that supports LDAP.

You can configure an Ext key as the LDAP key. If you press the LDAP key when the phone is idle, the IP phone will download and display the LDAP entries on the LCD screen of the phone. For more information on LDAP, refer to [LDAP Phonebook on Yealink IP Phones](#).

Note

Before configuring a LDAP key, you should enable the LDAP feature on the phone. Contact your system administrator for more information.

To configure an Ext key as the LDAP key:

1. Click on **Dsskey**->**Ext Key**.
2. In the desired Ext key field, select **LDAP** from the pull-down list of **Type**.
3. Enter the desired value in the **Label** field or leave it blank.

If you leave this field blank, the LCD screen of the EXP50 color-screen expansion module will display the default label "LDAP".

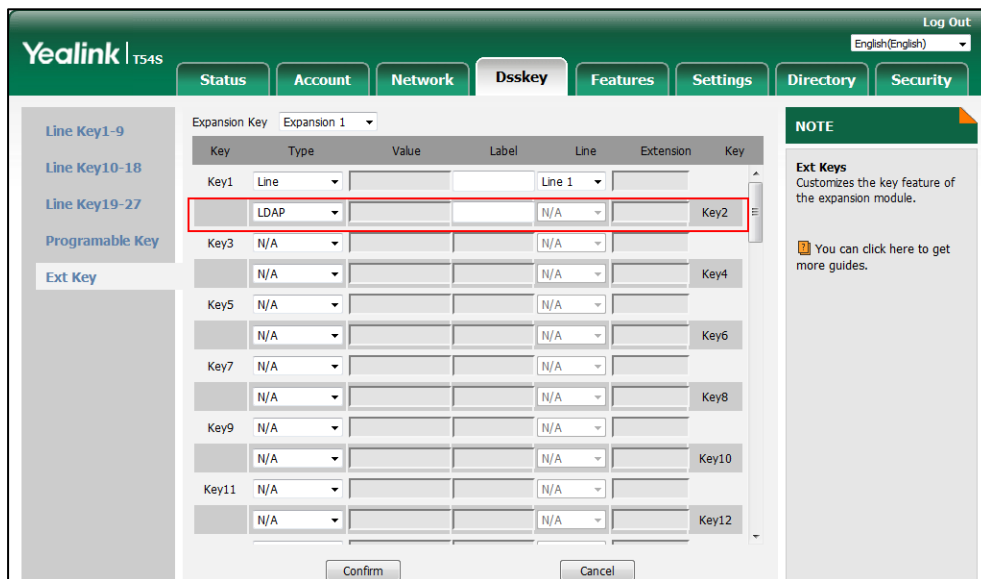

4. Click **Confirm** to accept the change

Conference

You can configure an Ext key as the conference key. When you are in a call, you can press the conference key to invite a third party to join a conference.

To configure an Ext key as the conference key:

1. Click on **Dsskey->Ext Key**.
2. In the desired Ext key field, select **Conference** from the pull-down list of **Type**.
3. Enter the phone number or extension of the destination party in the **Value** field or leave it blank.

If a phone number is configured, you can dial out the number by pressing the conference key when the phone is idle or during a call.

4. Enter the desired value in the **Label** field or leave it blank.

If you leave this field blank, the LCD screen of the EXP50 color-screen expansion module will display the default label "Conference".

The screenshot shows the Yealink T54S web interface with the 'Dsskey' tab selected. The 'Expansion Key' is set to 'Expansion 1'. The 'Ext Key' section is active, and the 'Type' dropdown for Key2 is set to 'Conference'. The 'Value' field is empty, and the 'Label' field contains '2301'. The 'Line' dropdown is set to 'Line 1'. A red box highlights the 'Type' dropdown and the 'Value' field. A 'NOTE' section on the right explains that 'Ext Keys' customize the key feature of the expansion module and provides a link to more guides.

Key	Type	Value	Label	Line	Extension	Key
Key1	Line		2301	Line 1		
	Conference			N/A		Key2
Key3	N/A			N/A		
	N/A			N/A		Key4
Key5	N/A			N/A		
	N/A			N/A		Key6
Key7	N/A			N/A		
	N/A			N/A		Key8
Key9	N/A			N/A		
	N/A			N/A		Key10
Key11	N/A			N/A		
	N/A			N/A		Key12

5. Click **Confirm** to accept the change.

Forward

You can configure an Ext key as the forward key. When the phone is idle, you can press the forward key to enter the setting screen of the call forward feature. When the phone receives an incoming call, you can press the forward key to forward the incoming call to the pre-defined number (if configured).

To configure an Ext key as the forward key:

1. Click on **Dsskey**->**Ext Key**.
2. In the desired Ext key field, select **Forward** from the pull-down list of **Type**.
3. Enter the destination number you want to forward the incoming calls to in the **Value** field or leave it blank.
4. Enter the desired value in the **Label** field or leave it blank.

If you leave this field blank, the LCD screen of the EXP50 color-screen expansion module will display the default label "Forward".

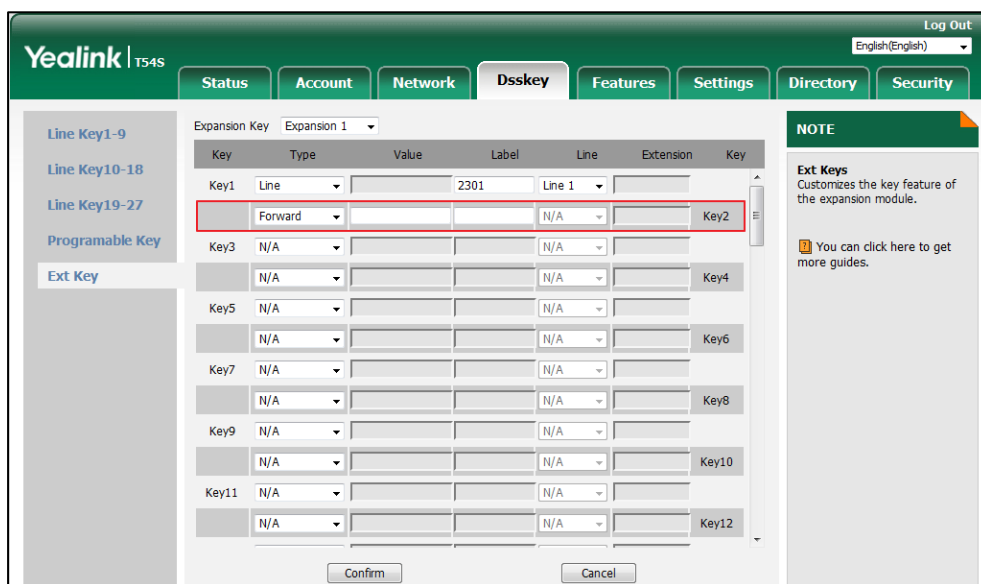

5. Click **Confirm** to accept the change.

Transfer

You can configure an Ext key as the transfer key. Then you can perform a Blind, Semi-Attended or Attended Transfer by pressing the transfer key during a call.

To configure an Ext key as the transfer key:

1. Click on **Dsskey**->**Ext Key**.
2. In the desired Ext key field, select **Transfer** from the pull-down list of **Type**.
3. Enter the phone number you want to transfer the call to in the **Value** field or leave it blank.
4. Enter the desired value in the **Label** field or leave it blank.

If you leave this field blank, the LCD screen of the EXP50 color-screen expansion module will display the default label "Transfer".

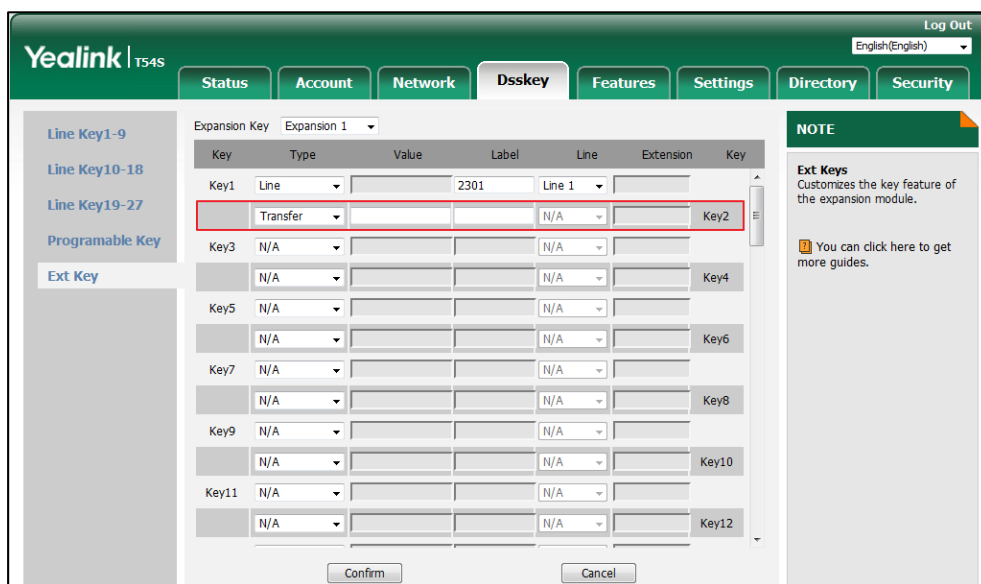

5. Click **Confirm** to accept the change.

Hold

You can configure an Ext key as the hold key. You can hold a call or retrieve a held call by pressing the hold key.

To configure an Ext key as the hold key:

1. Click on **Dsskey**->**Ext Key**.
2. In the desired Ext key field, select **Hold** from the pull-down list of **Type**.
3. Enter the desired value in the **Label** field or leave it blank.

If you leave this field blank, the LCD screen of the EXP50 color-screen expansion module will display the default label "Hold".

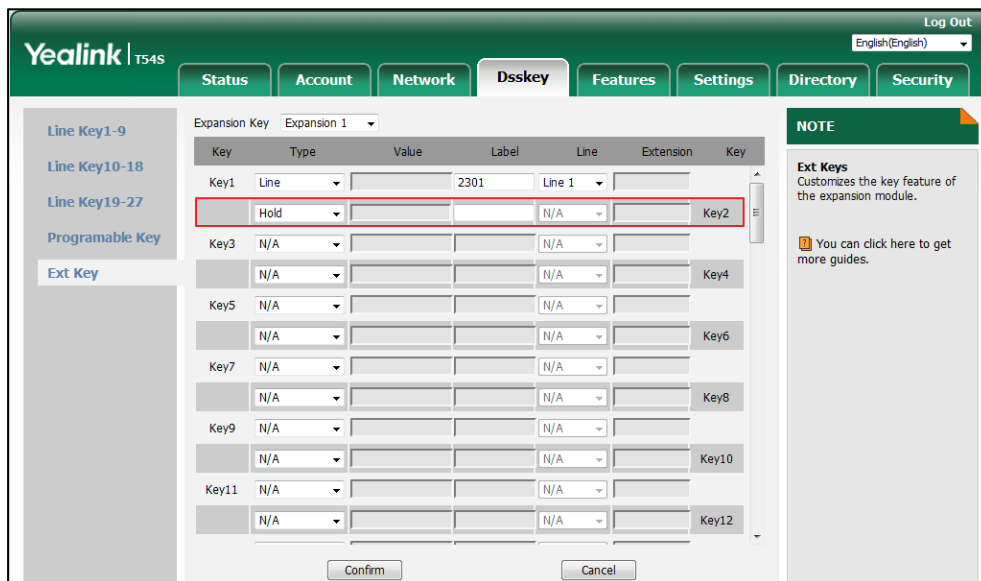

4. Click **Confirm** to accept the change.

DND

You can configure an Ext key as the DND key. If the DND key mode is configured to "phone", press the DND key when the phone is idle to activate or deactivate DND on a per-phone basis. If the DND key mode is configured to "custom", press the DND key when the phone is idle to enter the DND setting screen. For more information on DND mode, refer to the *DND* section of [Yealink phone-specific user guide](#).

To configure an Ext key as the DND key:

1. Click on **Dsskey**->**Ext Key**.
2. In the desired Ext key field, select **DND** from the pull-down list of **Type**.
3. Enter the desired value in the **Label** field or leave it blank.

If you leave this field blank, the LCD screen of the EXP50 color-screen expansion module will display the default label "DND".

The screenshot shows the Yealink T54S web interface with the 'Dsskey' tab selected. The 'Expansion Key' dropdown is set to 'Expansion 1'. A table lists keys from Key1 to Key12. Key2 is highlighted with a red border and has 'DND' selected in the 'Type' column. The 'Value' column is empty, and the 'Label' column contains 'N/A'. The 'Line' column is set to 'Line 1' and the 'Extension' column is empty. A 'NOTE' section on the right states: 'Ext Keys Customizes the key feature of the expansion module. You can click here to get more guides.' At the bottom, there are 'Confirm' and 'Cancel' buttons.

Key	Type	Value	Label	Line	Extension	Key
Key1	Line	2301		Line 1		
	DND		N/A			Key2
Key3	N/A			N/A		
	N/A			N/A		Key4
Key5	N/A			N/A		
	N/A			N/A		Key6
Key7	N/A			N/A		
	N/A			N/A		Key8
Key9	N/A			N/A		
	N/A			N/A		Key10
Key11	N/A			N/A		
	N/A			N/A		Key12

4. Click **Confirm** to accept the change.

ReCall

You can configure an Ext key as the ReCall key. Then you can place a call back to the caller of the last incoming call by pressing the ReCall key when the phone is idle.

To configure an Ext key as the ReCall key:

1. Click on **Dsskey**->**Ext Key**.
2. In the desired Ext key field, select **ReCall** from the pull-down list of **Type**.
3. Enter the desired value in the **Label** field or leave it blank.

If you leave this field blank, the LCD screen of the EXP50 color-screen expansion module will display the default label "ReCall".

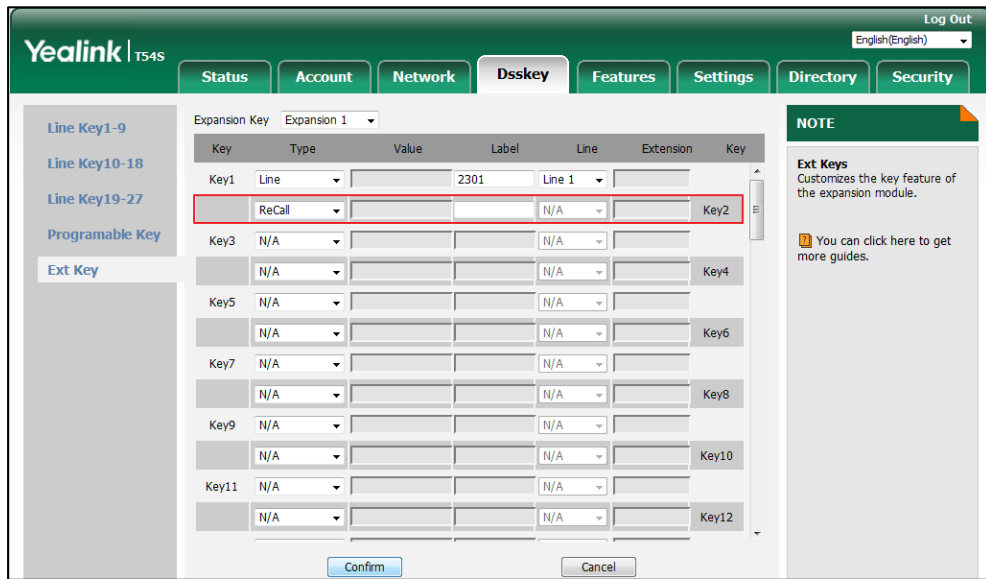

4. Click **Confirm** to accept the change.

SMS

You can configure an Ext key as the SMS key. Then you can access the text message screen more quickly and easily by pressing the SMS key.

To configure an Ext key as the SMS key:

1. Click on **Dsskey**->**Ext Key**.
2. In the desired Ext key field, select **SMS** from the pull-down list of **Type**.
3. Enter the desired value in the **Label** field or leave it blank.

If you leave this field blank, the LCD screen of the EXP50 color-screen expansion module will display the default label "SMS".

Key	Type	Value	Label	Line	Extension	Key
Key1	Line	2301		Line 1		
	SMS			N/A		Key2
Key3	N/A			N/A		
	N/A			N/A		Key4
Key5	N/A			N/A		
	N/A			N/A		Key6
Key7	N/A			N/A		
	N/A			N/A		Key8
Key9	N/A			N/A		
	N/A			N/A		Key10
Key11	N/A			N/A		
	N/A			N/A		Key12

4. Click **Confirm** to accept the change.

Record

Call recording allows users to record calls. Normally, there are 2 main methods to trigger a recording on a certain server. We call them record and URL record. Record is for the phone to send the server a SIP INFO message containing a specific header. URL record is for the phone to send an HTTP URL to the server. The server processes these messages and decides to start or stop a recording.

You can configure an Ext key as the record key. Then you can record calls using the record method by pressing the record key. For more information on URL record, refer to [URL Record](#) on page 49.

To configure an Ext key as the record key:

1. Click on **Dsskey**->**Ext Key**.
2. In the desired Ext key field, select **Record** from the pull-down list of **Type**.
3. Enter the desired value in the **Label** field or leave it blank.

If you leave this field blank, the LCD screen of the EXP50 color-screen expansion module will display the default label "Record"

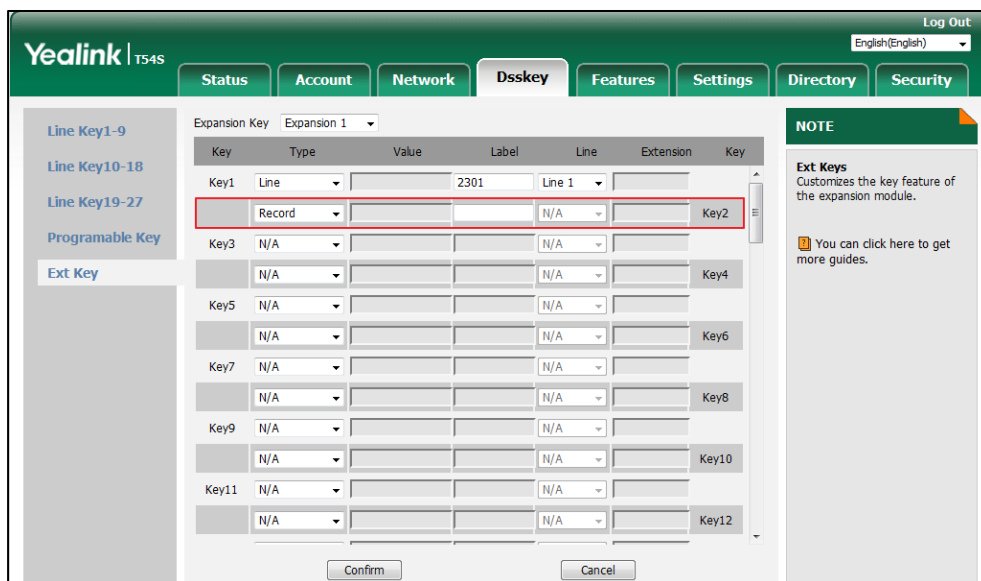

4. Click **Confirm** to accept the change.

URL Record

You can configure an Ext key as the URL record key. Then you can record calls using the URL record method by pressing the call record key.

To configure an Ext key as the URL record key:

1. Click on **Dsskey->Ext Key**.
2. In the desired Ext key field, select **URL Record** from the pull-down list of **Type**.
3. Enter the URL in the **Value** field (e.g., http://10.2.1.65).
4. Enter the desired value in the **Label** field or leave it blank.

If you leave this field blank, the LCD screen of the EXP50 color-screen expansion module will display the default label "URL Record".

Key	Type	Value	Label	Line	Extension	Key
Key1	Line	2301		Line 1		
	URL Record	http://10.2.1.65		N/A		Key2
Key3	N/A			N/A		
	N/A			N/A		Key4
Key5	N/A			N/A		
	N/A			N/A		Key6
Key7	N/A			N/A		
	N/A			N/A		Key8
Key9	N/A			N/A		
	N/A			N/A		Key10
Key11	N/A			N/A		
	N/A			N/A		Key12

5. Click **Confirm** to accept the change.

Multicast Paging

Multicast paging feature allows you to quickly and easily announce time sensitive announcements to people within the multicast group. You can configure a multicast paging key on the phone, which allows you to send a Real Time Transport Protocol (RTP) stream to the pre-configured multicast address(es) without involving SIP signaling.

To configure an Ext key as the multicast paging key:

1. Click on **Dsskey**->**Ext Key**.
2. In the desired Ext key field, select **Paging** from the pull-down list of **Type**.
3. Enter the multicast IP address and port number in the **Value** field (e.g., 224.5.6.20:10008).

The valid multicast IP addresses range from 224.0.0.0 to 239.255.255.255.

4. Enter the desired value in the **Label** field or leave it blank.

If you leave this field blank, the LCD screen of the EXP50 color-screen expansion module will display "the value specified in the Value field" (e.g., 224.5.6.20:10008).

5. Enter the desired channel in the **Extension** field.

The valid channel ranges from 0 to 30.

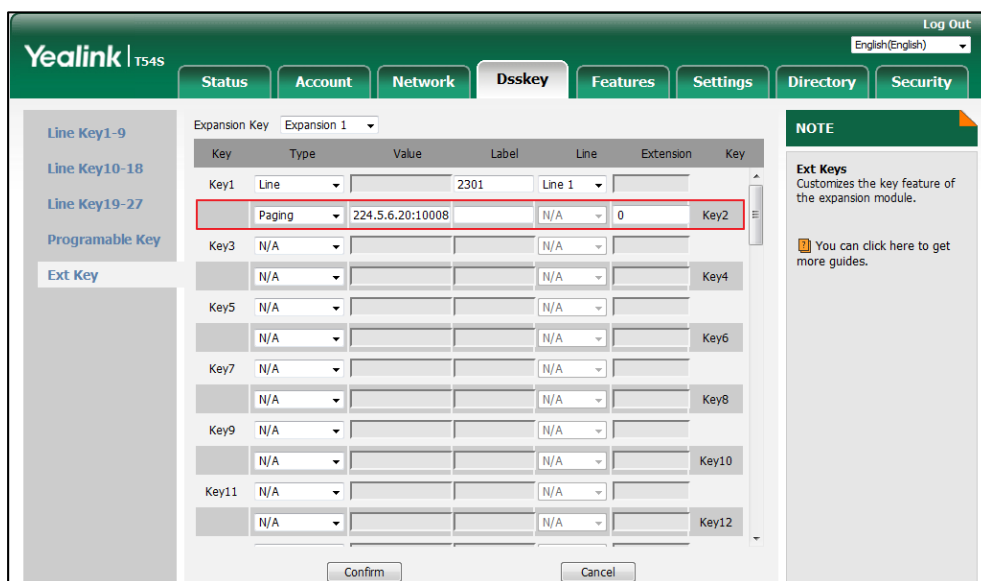

6. Click **Confirm** to accept the change.

Group Listening

You can configure an Ext key as the group listening key. Then you can activate the Speakerphone mode and Handset/Headset mode at the same time by pressing the group listening key. It is suitable for the group conversation which has more than one person at one side. You are able to speak and listen using the handset/headset; meanwhile the others nearby can only listen using the speaker. You can get back to the previous mode by pressing the group listening key again.

To configure an Ext key as the group listening key:

1. Click on **Dsskey**->**Ext Key**.
2. In the desired Ext key field, select **Group Listening** from the pull-down list of **Type**.
3. Enter the desired value in the **Label** field or leave it blank.

If you leave this field blank, the LCD screen of the EXP50 color-screen expansion module will display the default label "Group Listening".

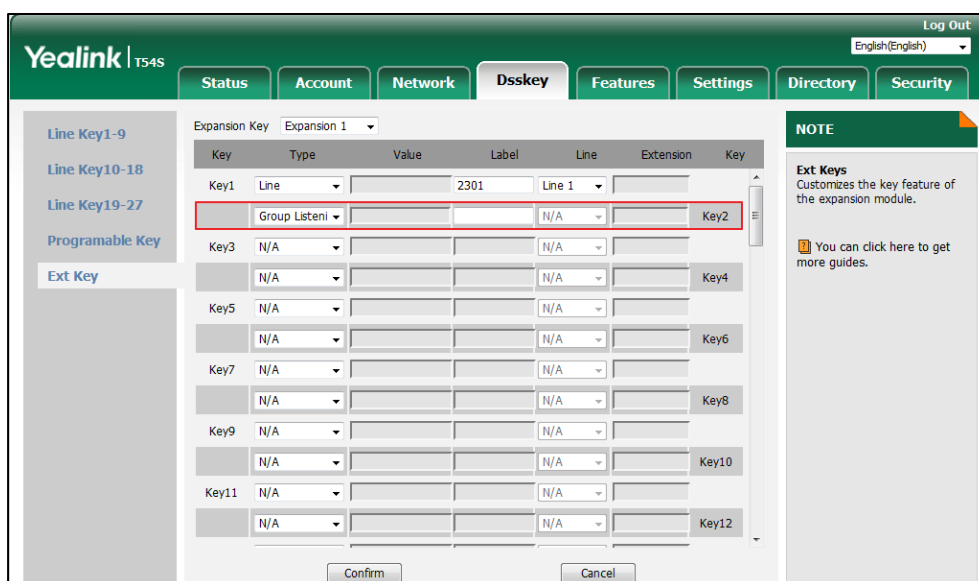

4. Click **Confirm** to accept the change.

Private Hold

You can configure an Ext key as the private hold key. Then you can private hold a shared call by pressing the Private hold key when using Shared Call Appearance.

To configure an Ext key as the private hold key:

1. Click on **Dsskey->Ext Key**.
2. In the desired Ext key field, select **Private Hold** from the pull-down list of **Type**.
3. Enter the desired value in the **Label** field or leave it blank.

If you leave this field blank, the LCD screen of the EXP50 color-screen expansion module will display the default label "Private Hold".

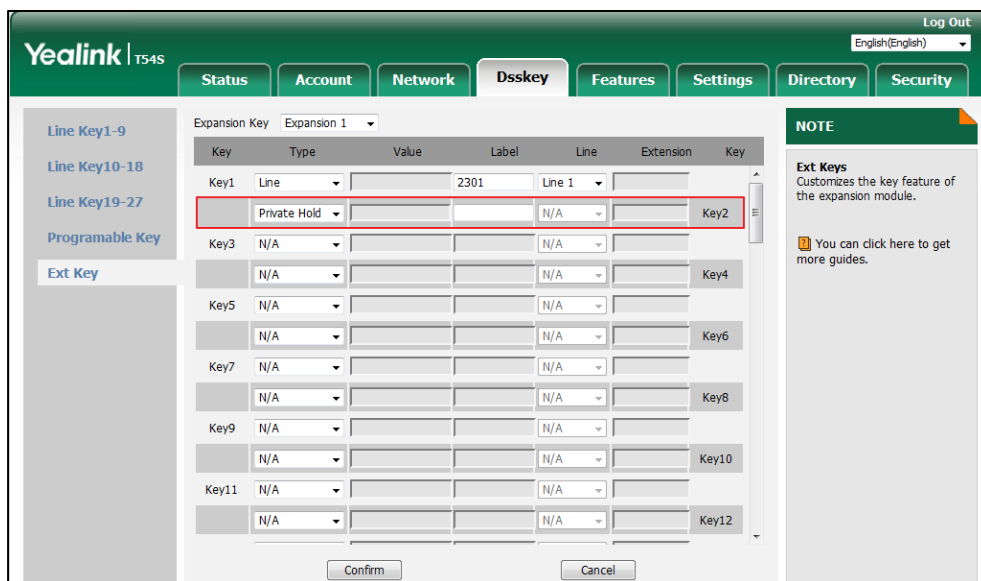

4. Click **Confirm** to accept the change.

Hot Desking

Hot Desking is regularly used in places where not all the employees are in the office at the same time, or not in the office for a very long time, which means actual personal offices would be often vacant, consuming valuable space and resources.

Hot Desking is a phone feature that allows users to login or logout an IP phone. You can configure an Ext key as the hot desking key. Press the hot desking key to delete all accounts on the IP phone, and then register your account on line 1.

To configure an Ext key as the hot desking key:

1. Click on **Dsskey->Ext Key**.
2. In the desired Ext key field, select **Hot Desking** from the pull-down list of **Type**.
3. Enter the desired value in the **Label** field or leave it blank.

If you leave this field blank, the LCD screen of the EXP50 color-screen expansion module will display the default label "Hot Desking".

The screenshot shows the Yealink T54S web interface with the 'Dsskey' tab selected. The 'Expansion Key' is set to 'Expansion 1'. A table lists keys from Key1 to Key12. Key2 is highlighted with a red box, showing 'Hot Desking' selected in the 'Type' dropdown and an empty 'Label' field. Other keys have 'N/A' in the 'Type' dropdown. A 'NOTE' section on the right explains that 'Ext Keys' customize the key feature and provides a link to guides. 'Confirm' and 'Cancel' buttons are at the bottom.

Key	Type	Value	Label	Line	Extension	Key
Key1	Line	2301		Line 1		
Key2	Hot Desking			N/A		Key2
Key3	N/A			N/A		
Key4	N/A			N/A		Key4
Key5	N/A			N/A		
Key6	N/A			N/A		Key6
Key7	N/A			N/A		
Key8	N/A			N/A		Key8
Key9	N/A			N/A		
Key10	N/A			N/A		Key10
Key11	N/A			N/A		
Key12	N/A			N/A		Key12

4. Click **Confirm** to accept the change.

ACD

ACD feature is often used in offices for customer service, such as call center. The ACD system handles large volumes of incoming calls from callers who have no need to talk to a specific person but who require assistance from any of multiple persons at the earliest opportunity. The ACD feature on the IP phone allows the ACD system to distribute calls from large volumes of incoming calls to the registered IP phone users.

To use the ACD feature, you should configure an Ext key as the ACD key in advance. You can press the ACD key to log in the ACD system.

To configure an Ext key as the ACD key:

1. Click on **Dsskey**-> **Ext Key**.
2. In the desired Ext key field, select **ACD** from the pull-down list of **Type**.
3. Enter the desired value in the **Label** field.

If you leave this field blank, the LCD screen of the EXP50 color-screen expansion module will display the default label "ACD".

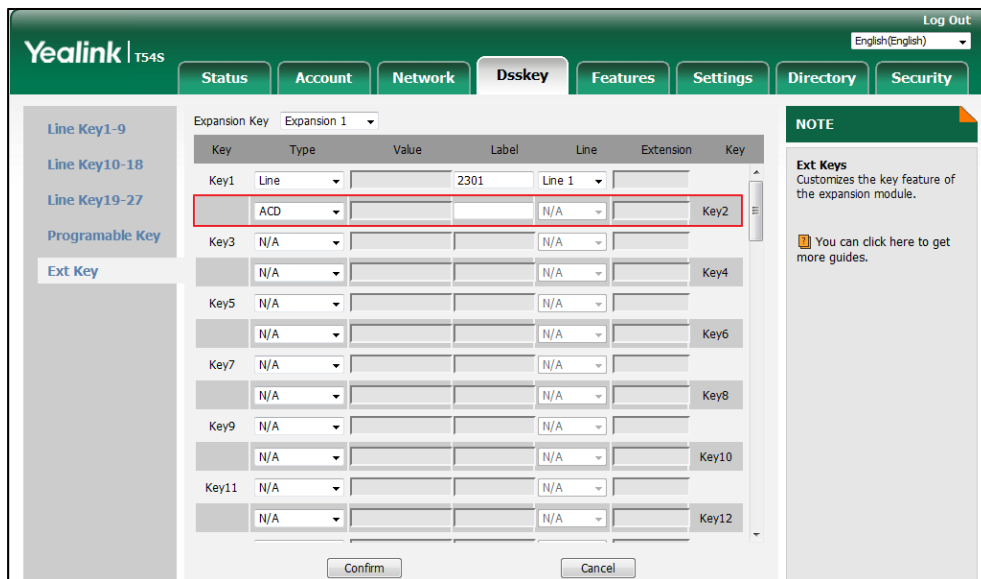

4. Click **Confirm** to accept the change.

Zero Touch

You can configure an Ext key as the zero touch key. Then you can configure auto provision and network parameters quickly by pressing the zero touch key when the phone is idle.

To configure an Ext key as the zero touch key:

1. Click on **Dsskey**->**Ext Key**.
2. In the desired Ext key field, select **Zero Touch** from the pull-down list of **Type**.
3. Enter the desired value in the **Label** field or leave it blank.

If you leave this field blank, the LCD screen of the EXP50 color-screen expansion module will display the default label "Zero Touch".

Key	Type	Value	Label	Line	Extension	Key
Key1	Line	2301		Line 1		
	Zero Touch		N/A			Key2
Key3	N/A		N/A			
	N/A		N/A			Key4
Key5	N/A		N/A			
	N/A		N/A			Key6
Key7	N/A		N/A			
	N/A		N/A			Key8
Key9	N/A		N/A			
	N/A		N/A			Key10
Key11	N/A		N/A			
	N/A		N/A			Key12

4. Click **Confirm** to accept the change.

URL

You can configure an Ext key as the URL key. If you press the URL key, the phone will send HTTP requests to a web server.

To configure an Ext key as the URL key:

1. Click on **DSSKEY->Ext Key**.
2. In the desired Ext key field, select **URL** from the pull-down list of **Type**.
3. Enter the URL of the web server you want to access in the **Value** field (e.g., `http://192.168.0.1`).
4. Enter the desired value in the **Label** field or leave it blank.

If you leave this field blank, the LCD screen of the EXP50 color-screen expansion module will display the default label "URL".

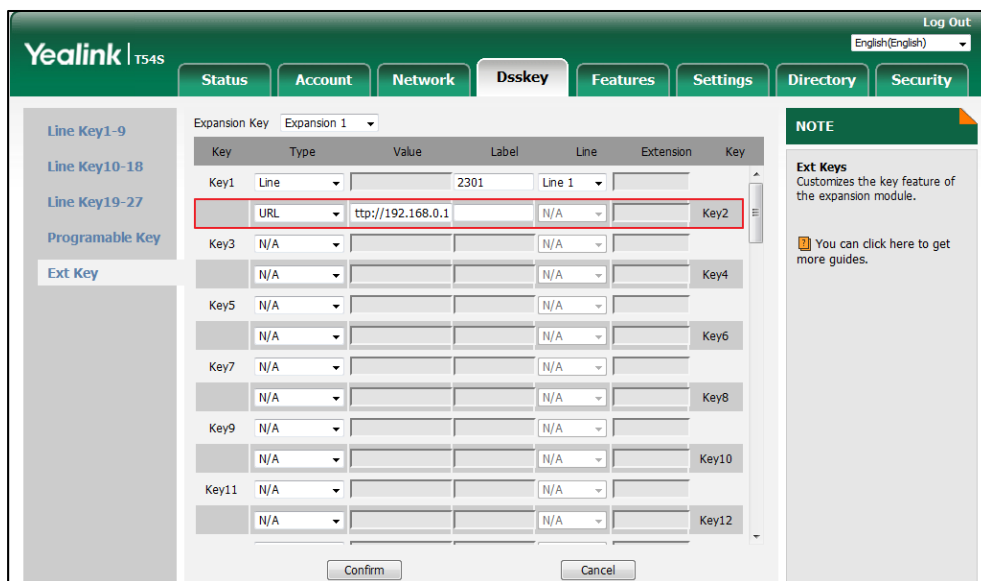

5. Click **Confirm** to accept the change.

Phone Lock

You can configure an Ext key as the phone lock key. Then you can press the phone lock key to immediately lock the keypad of your phone instead of long pressing the pound key.

To configure an Ext key as the phone lock key:

1. Click on **Dsskey**->**Ext Key**.
2. In the desired Ext key field, select **Phone Lock** from the pull-down list of **Type**.
3. Enter the desired value in the **Label** field or leave it blank.

If you leave this field blank, the LCD screen of the EXP50 color-screen expansion module will display the default label "Phone Lock".

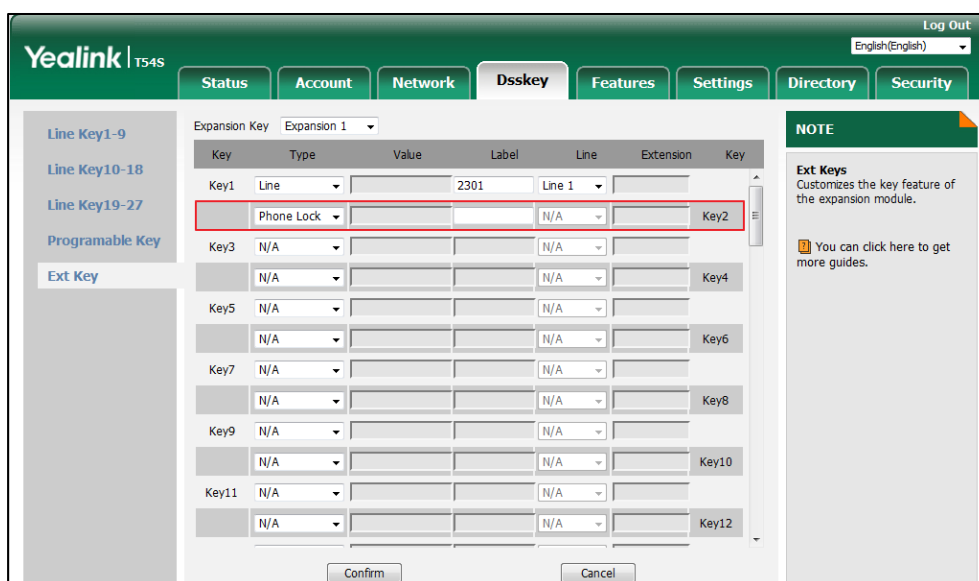

4. Click **Confirm** to accept the change.

Retrieve Park

You can configure an Ext key as the retrieve park key. You can press the retrieve park key to retrieve a parked call.

To configure an Ext key as the retrieve park key:

1. Click on **Dsskey**->**Ext Key**.
2. In the desired Ext key field, select **Retrieve Park** from the pull-down list of **Type**.
3. Enter the desired value in the **Label** field or leave it blank.

If you leave this field blank, the LCD screen of the EXP50 color-screen expansion module will display the default label "Retrieve Park".

- Select the desired line to apply this key from the pull-down list of **Line**.

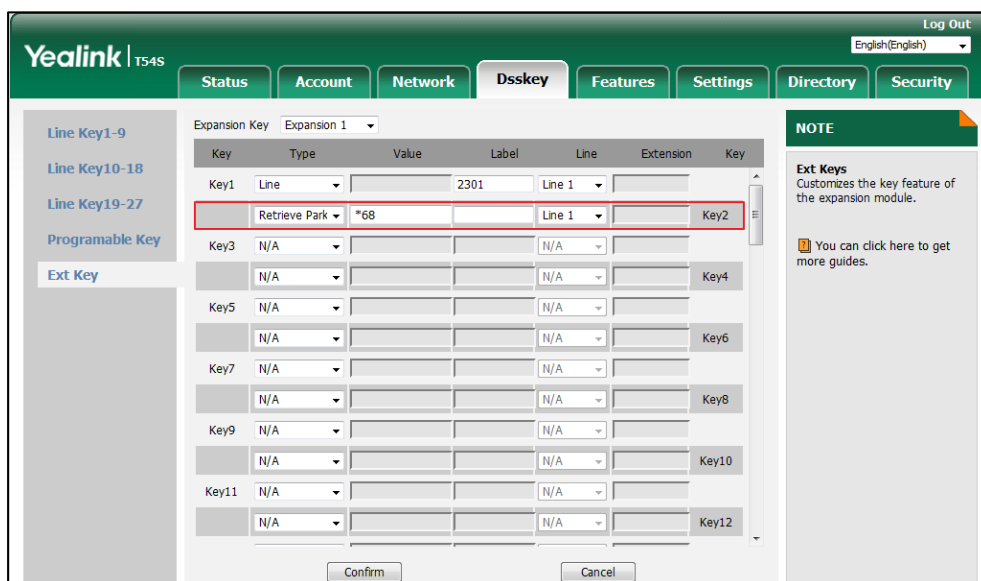

- Click **Confirm** to accept the change.

Directory

You can configure an Ext key as the directory key. You can press the directory key to quickly access the local directory, call history, LDAP and remote phone book.

To configure an Ext key as the directory key:

- Click on **Dsskey->Ext Key**.
- In the desired Ext key field, select **Directory** from the pull-down list of **Type**.
- Enter the desired value in the **Label** field or leave it blank.

If you leave this field blank, the LCD screen of the EXP50 color-screen expansion module will display the default label "Directory".

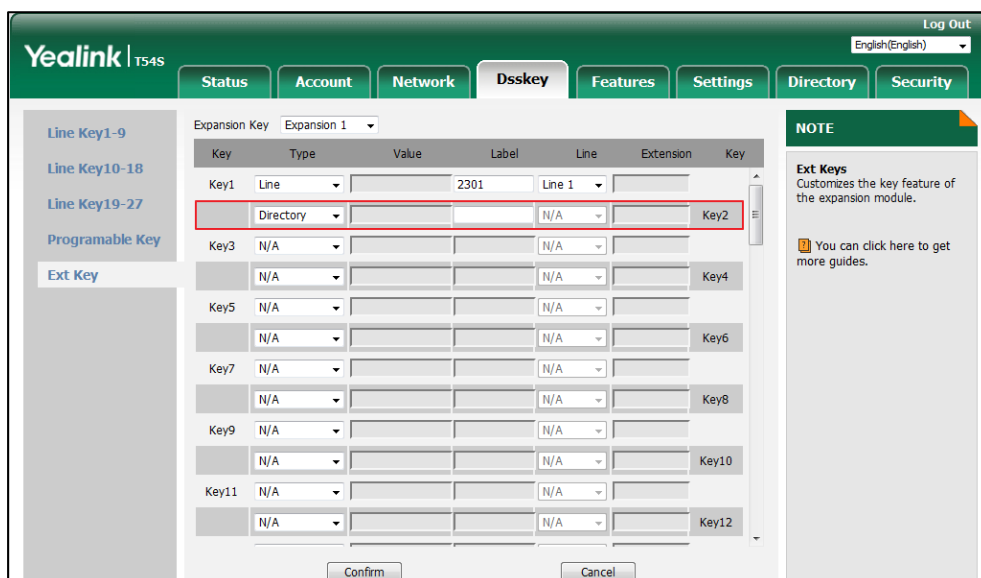

4. Click **Confirm** to accept the change.

Using the Yealink EXP50 Color-screen Expansion Module

The use of Ext keys on the EXP50 color-screen expansion module and DSS keys on the IP phone are almost the same. For more information on using DSS keys on the IP phone, refer to [Yealink phone-specific user guide](#).

This chapter provides you the following operating instructions for the EXP50 color-screen expansion module. Topics include:

- [Using the Line Key](#)
- [Using the Busy Lamp Field](#)
- [Resetting the Yealink EXP50 Color-screen Expansion Module](#)



Using the Line Key

You can configure line keys to associate with a line for the connected EXP50 color-screen expansion module. Incoming calls to the line can be distributed evenly among the available line keys both on the host phone and the connected EXP50 color-screen expansion module. Each line key on the connected EXP50 color-screen expansion module can only handle one call. For more information on configuring an Ext key as the line key, refer to [Line](#) on page 26.

You can use a line key to do the following:

- Placing a call
- Answering a call
- Placing an active call on hold
- Resuming a held call

To place a call using the line key:

1. Press the line key on the EXP50 color-screen expansion module, the host phone will enter the pre-dialing screen.
2. Enter the desired number using the keypad on the host phone.
3. Press  ,  or the **Send** soft key on the host phone.

For more information on placing a call, refer to the *Placing Calls* section of [Yealink phone-specific user guide](#).

To answer a call using the line key:

1. Press the line key with the fast-flashing green LED indicator on the EXP50 color-screen expansion module.

Note

The line configured on the phone takes precedence over that configured on the color-screen expansion module. Only if the line configured on the phone is being used, the LED indicator of the line key corresponding to this line on the color-screen expansion module will fast flash green when this line receives a new incoming call.

To place an active call on hold using the line key:

1. Press the line key corresponding to line with the active call you want to place on hold.

To resume a held call using the line key:

1. Press the line key corresponding to line with the held call you want to resume.

You can also view the line status through LED indicators. For more information on line key LED indications, refer to [LED Instructions](#) on page 8.

Using the Busy Lamp Field

The busy lamp field (BLF) feature allows you to monitor the status change of users through BLF LED indicators. For example, you can configure a BLF key on the connected EXP50 color-screen expansion module to monitor the status of a friend's line (busy or idle). For more information on configuring an Ext key as the BLF key, refer to [Busy Lamp Field \(BLF\)](#) on page 28.

The BLF key LED illuminates solid red when the monitored line is in use. The BLF key LED illuminates solid green when the monitored line is idle. For more information on BLF key LED indications, refer to [LED Instructions](#) on page 8.

You can press a BLF key to dial out the monitored phone number when the monitored line is idle and pick up calls that are received on the monitored line. When there is an active call on the host phone, you can transfer the active call to the monitored phone number directly by pressing the BLF key.

For more information on using BLF feature on the phone, refer to the *Busy Lamp Field (BLF)* section of [Yealink phone-specific user guide](#).

Resetting the Yealink EXP50 Color-screen Expansion Module

You can reset the EXP50 color-screen expansion module to clear all configurations by resetting the host phone. The reset process of the EXP50 color-screen expansion module is synchronized with the host phone.

To reset the EXP50 color-screen expansion module via phone user interface:

1. Press **Menu->Advanced** (password: admin) ->**Reset Config->Reset to Factory** on the host phone.
2. Press the **Reset** soft key on the host phone.

The LCD screen of the host phone prompts the following warning:



3. Press the **OK** soft key on the host phone.

The LCD screen of the host phone prompts "Welcom Initializing...Please wait".

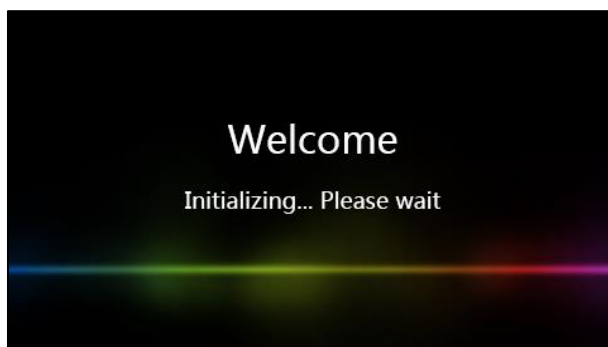

The host phone and the EXP50 color-screen expansion module will be reset to factory settings successfully after startup.

Note

Reset of the EXP50 color-screen expansion module can lead to resetting the host phone. And then all custom settings on the host phone and the EXP50 color-screen expansion module will be overwritten after resetting.