

Handset Operations Manual

RTX 8830

Contents

Handset Operations Manual.....	1
Contents.....	2
1 About This Document	5
1.1 Audience	5
1.2 Abbreviations.....	5
1.3 References/Related Documentations.....	5
1.4 Document History	5
2 Making Handset Ready	6
2.1 Package - Contents/Damage Inspection	6
2.1.1 Before Package Is Opened	6
2.1.2 Contents of Package	6
2.1.3 Damage Inspection	7
2.2 Before Using the Phone	7
2.2.1 Installing the Battery.....	7
2.2.2 Using the Charger	7
2.2.3 Handset in the Charger	7
2.2.4 How to Open Back Cover	8
2.2.5 How to Replace Battery	8
2.2.6 Handset IPEI Number and SD Card	8
3 Phone Overview.....	9
3.1 Handset Front View and Top View	9
3.2 Handset – Rear View.....	10
4 Display.....	11
4.1 Icons and Text in the Display	11
4.2 Menu icons	12
4.3 Keys and Buttons	13
4.3.1 Navigation Keys/Selection Key	13
4.3.2 Softkeys.....	13
4.3.3 Speaker Key.....	14
4.3.4 Activity Menu Key	14
4.3.5 Off-hook Key	14
4.3.6 On-hook, and On/Off Key	14
4.3.7 Speed Dial Keys.....	14
4.3.8 Volume Button.....	14
4.3.9 Mute Button	14
4.4 The Keypad	15
4.4.1 Idle Mode, and Number Input Mode.....	15
4.4.2 In Text Input Mode	15
4.4.3 Silent Mode from #-Key	16

5	Basic Operation.....	17
5.1	How to Switch the Handset On/Off.....	17
5.2	Lock/Unlock the Keypad.....	17
5.3	Entering a number in idle.....	17
6	Menu Operation.....	18
6.1	Contacts.....	18
6.1.1	Add Contact.....	19
6.1.2	Call/Edit a Contact.....	19
6.1.3	More Contacts Options.....	20
6.1.4	Speed dial/One Touch Dial.....	20
6.2	Central Directory.....	22
6.2.1	LDAP Mode and Local Mode.....	22
6.2.2	Calling a Contact in the Central Directory.....	24
6.2.3	Line.....	24
6.3	Calls.....	24
6.3.1	Call.....	26
6.3.2	View.....	26
6.3.3	More Calls Options.....	27
6.4	Connectivity.....	28
6.4.1	Register.....	28
6.4.2	Deregister.....	29
6.4.3	Select Network.....	29
6.5	Settings.....	30
6.5.1	Audio settings.....	30
6.5.2	Time & Date.....	38
6.5.3	Language.....	39
6.5.4	LED Signal.....	39
6.5.5	Power Save.....	40
6.5.6	Security.....	41
6.5.7	Handset Name, Line, Reset Settings, Status.....	41
6.5.8	Auto Answer.....	43
6.5.9	Silent Charging.....	44
6.5.10	Do Not Disturb.....	45
6.5.11	Hide Number.....	45
6.5.12	Call Forward.....	46
6.5.13	Idle Screen Saver.....	47
6.5.14	Bluetooth.....	47
6.6	Messaging.....	50
6.6.1	How to Setup Text Messaging.....	51
6.6.2	How to Write a New Message.....	52
6.6.3	How to Send a New Message.....	53
6.6.4	How to Open and Reply to a Message.....	54
6.6.5	Four Messaging Submenus.....	54
6.6.6	Drafts.....	55
6.6.7	Inbox.....	56
6.6.8	Sent messages.....	57
6.6.9	Settings.....	58
6.7	Alarms.....	59

6.8 F-Keys.....	61
6.9 Alarm List	62
6.9.1 How to Trigger Alarms on the Handset	62
6.9.2 How to Control the Emergency Settings on the Base Station Web Interface	63
6.9.1 The Alarm List Menu.....	66
6.9.2 An Incoming Alarm	66
7 Calls Operations.....	68
7.1 Incoming call.....	68
7.1.1 Answering an Incoming Call.....	68
7.1.2 Reject an Incoming Call.....	68
7.1.3 Silencing an Incoming Call	69
7.1.4 Ending a Call.....	69
7.2 Initiating a Call	69
7.2.1 Initiating a Call from Idle.....	69
7.2.2 Initiating a Call from Contacts	70
7.2.3 Initiating a Call from Calls	70
7.2.4 Initiating a Call from the Central Directory.....	70
7.3 Call Holding/Retrieving	71
7.4 Attended and Unattended Transfer of a Call.....	71
7.4.1 Attended Transfer.....	71
7.4.2 Unattended Transfer	72
7.5 Swap between Two Calls	73
7.6 Call Waiting	74
7.7 Conference Call.....	75
7.7.1 Establishing a Conference Call.....	75
7.7.2 Terminating a Conference Call.....	76
8 SD Card.....	78
8.1 How to Insert the SD Card in the Handset.....	78
8.2 Inserting a SD Card With or Without Information	78
8.2.1 Inserting an Empty SD Card	78
8.2.2 Inserting an SD Card Containing Information	78
8.3 SD Card White List	79
9 Accessories.....	80
10 Troubleshooting.....	81
10.1 Operational problems.....	81

1 About This Document

This document describes the features and functionalities available in the RTX SME VoIP DECT 8830 Handset. We describe how to operate the handset without going into details of its mechanical features.

1.1 Audience

This guide is intended for everyday users as well as system administrators.

1.2 Abbreviations

For the purpose of this document, the following abbreviations hold:

DECT:	Digital Enhanced Cordless Telecommunications
IPEI:	International Portable Equipment Identity
MAC:	Media Access Control
PBX:	Private Branch Exchange

1.3 References/Related Documentations

[1]:	Adding Multiple Base Stations to Network V0.2 Document
[2]:	How to Initiate Force Handover Procedure V0.2
[3]:	SME VoIP System Guide, Version 2.0

1.4 Document History

Revision	Author	Issue Date	Comments
1.0	KMH	24-July-2014	New version
1.2	KMH	22-July-2014	Updated with handset pictures

2 Making Handset Ready

In this chapter we briefly describe how to prepare the handset for use, install, and how to insert and charge new batteries.

2.1 Package - Contents/Damage Inspection

2.1.1 Before Package Is Opened

Examine the shipping package for evidence of physical damage or mishandling prior to opening. If there is proof of mishandling prior to opening, you must report it to the relevant support center of the regional representative or operator.

2.1.2 Contents of Package

Make sure all relevant components are available in the package before proceeding to the next step. In principle, every shipped base unit package/box contains the following items:

- 1 x Handset Unit
- 1 x Battery
- 1 x Charger
- 1 x A/C Adaptor
- 1 x Belt Clip Cover
- 1 x Pull Cord Cover
- 1 x Belt Clip
- 1 x Svirvel for belt clip
- 2 x Mounting Screws

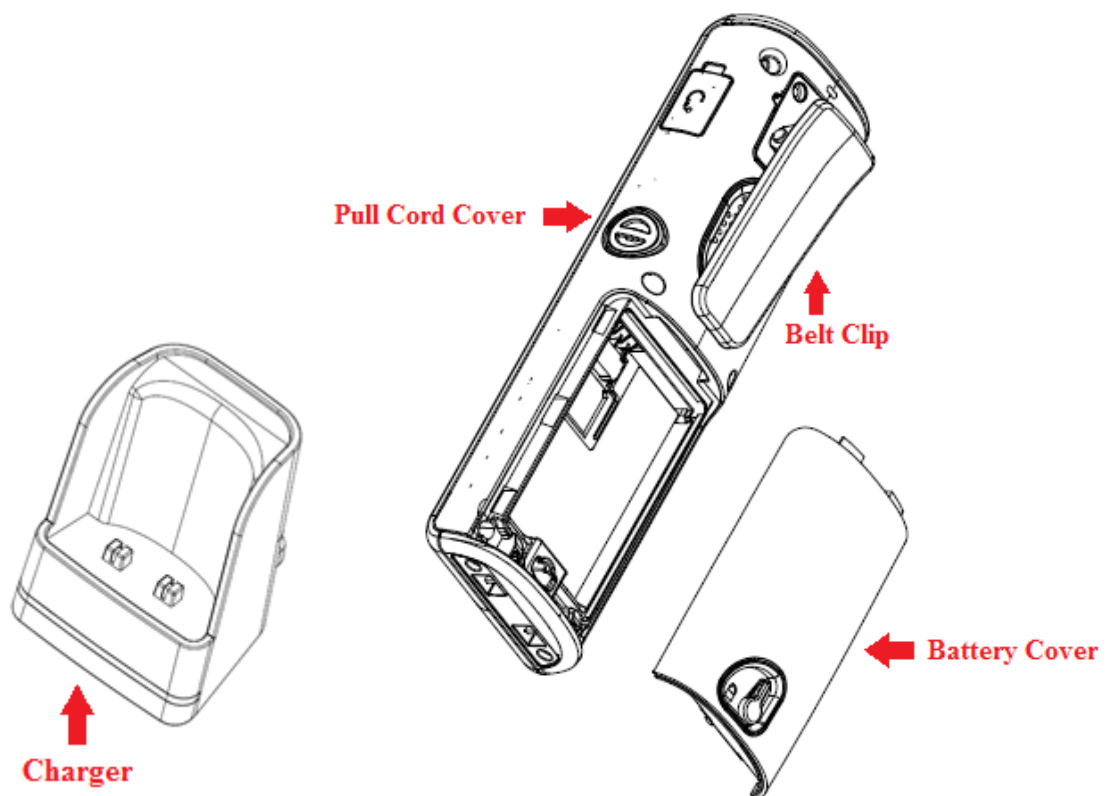

2.1.3 Damage Inspection

The following are the recommended procedure for you to use for damage inspection:

1. Examine all relevant components for damage.
2. Make a “defective on arrival - DOA” report or RMA to the operator. Do not move the shipping carton until it has been examined by the operator. The operator/regional representative will initiate the necessary procedure to process this RMA. They will guide the network administrator on how to return the damaged package if necessary.
3. If no damage is found then unwrap all the components and dispose of empty package/carton(s) in accordance with country specific environmental regulations.

2.2 Before Using the Phone

The following are the precautions users should read before using the handset:

2.2.1 Installing the Battery

1. Never dispose battery in fires, otherwise it will explode.
2. Never replace the batteries in potentially explosive environments, e.g. close to inflammable liquids/gases.
3. ONLY use approved batteries and chargers from the vendor or operator.
4. Do not disassemble, customize or short circuit the battery

2.2.2 Using the Charger

Each handset is charged through the use of a handset charger. The charger is a compact desktop unit designed to charge and automatically maintain the correct battery charge levels and voltage. The handset charger is powered by AC supply from 110-240VAC that supplies 5.5VDC at 600mA. When charging the battery for the first time, it is necessary to leave the handset in the charger for at least 10 hours before the battery is fully charged, and the handset is ready for use.

2.2.3 Handset in the Charger

For correct charging, ensure that the room temperature is between 0°C and 25°C / 32°F and 77°F. Do not place the handset in direct sunlight. The battery has a built-in heat sensor which will stop charging if the battery temperature is too high.

If the handset is turned off when placed in charger, the handset turns on and shows (shortly) the charging message “The battery is charging”. After a while the display backlight first dim and then turns off (if demo mode is not enabled). There will be response for e.g. incoming calls.

If the handset is turned on when placed in charger, the display shows (shortly) the charging message “The battery is charging”. After a while the display backlight first dim and then turns off if unless “Idle Screen Saver” is switched on.

2.2.4 How to Open Back Cover

1. Twist the back-cover lock to open position and lift back cover away from the handset.
2. Remove Back Cover from Handset

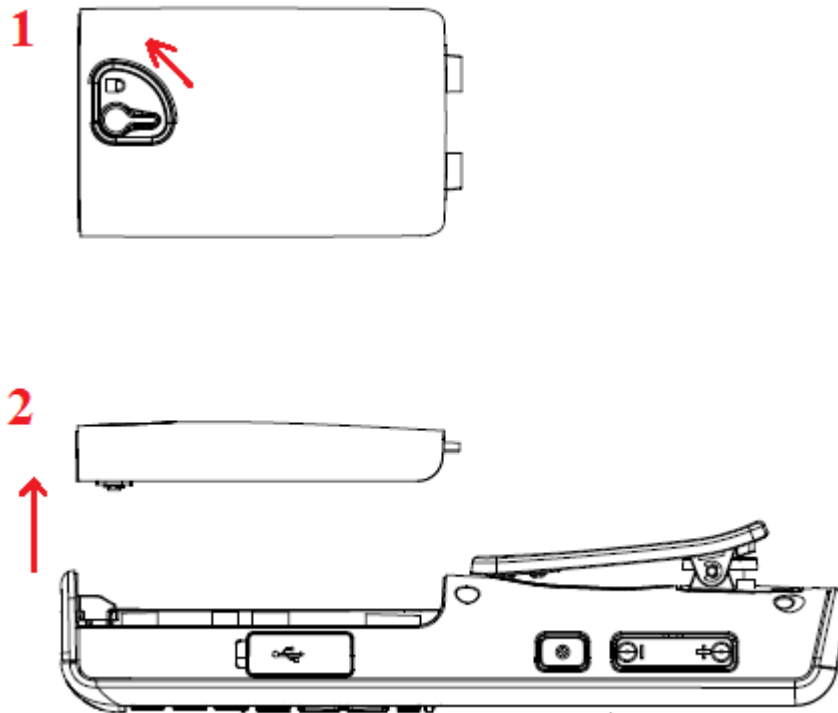

2.2.5 How to Replace Battery

Remove the back cover from the handset as showed in section 2.2.4 *How to Open Back Cover* above. Then remove the old battery and replace with a new one.

2.2.6 Handset IPEI Number and SD Card

The serial number and IPEI/IPUI number of each handset is found either on a label, which is placed behind the battery, or on the packaging label. First, lift off handset back cover and lift the battery and read the serial number.

An SD Card can be inserted behind the battery as well.

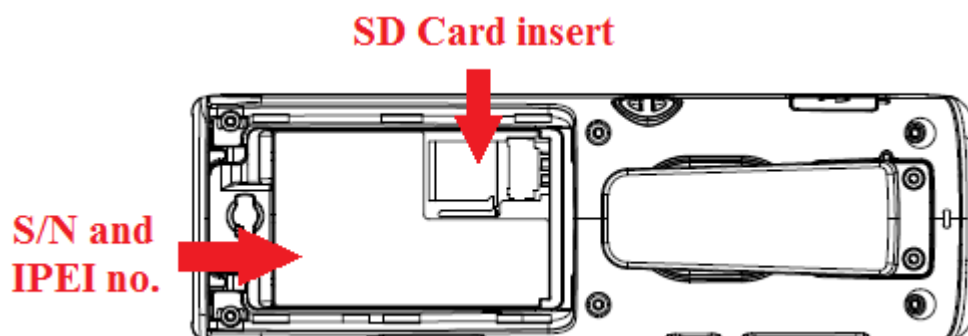

3 Phone Overview

This section contains an overview of the handset from a front and a rear view.

3.1 Handset Front View and Top View

1. **Earpiece Speaker**
2. **Screen**
3. **Navigation Keys (Up/Down/Right/left)**
4. **Selection Key (Centre of Navigation Keys)**
5. **Call Key/ Accept Call Key (Off-hook key)**
To answer a call, and functions as a short cut to the Call list.
6. **End, ON/OFF Key, Back Key (On-hook key)**
To end call, to return to a previous menu, and to switch the handset on/off by long press.
7. **Activity Menu Key**
To enter all the menus available on the handset.
8. **Speaker Key**
To enable/disable speaker mode during call.
9. **3 Softkeys**
Are used for different commands in the different menus on the handset, and changes according to what is displayed on the screen.
10. **LED**
Indicates incoming call, missed call, messaging, low battery, and charging.
11. **Emergency Button**

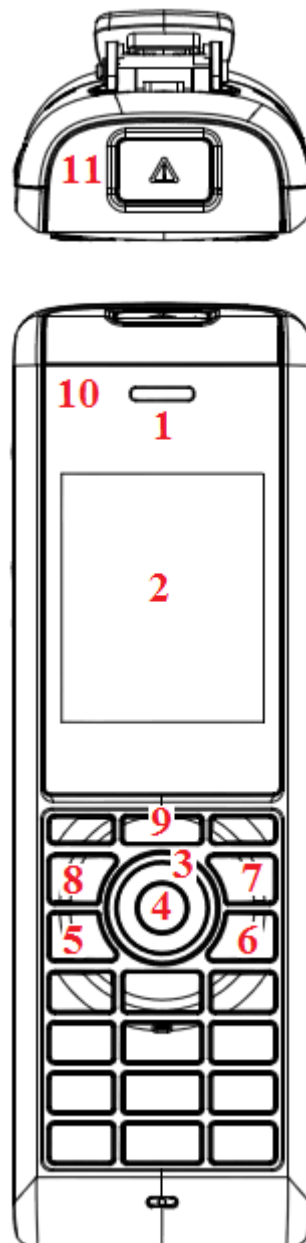

3.2 Handset – Rear View

12. Headset connector (3.5mm)

This is for connecting a headset. The connector is protected against dust by the headset connector cover.

13. Belt Clip

14. Pull Cord

For using a magnetic pull cord to activate the pull cord alarm.

15. Volume Up/Down Key (Side Key)

To increase/decrease the volume during call.

16. Mute Key (Side Key)

To turn off the microphone in call, so that the counterpart is muted.

17. External Speaker

Is used for ringing, alarms, and when speaker mode is enabled in call.

18. Battery

19. Back Cover Lock

Can be switched from open/locked position according to if the back cover should be able to be removed or not

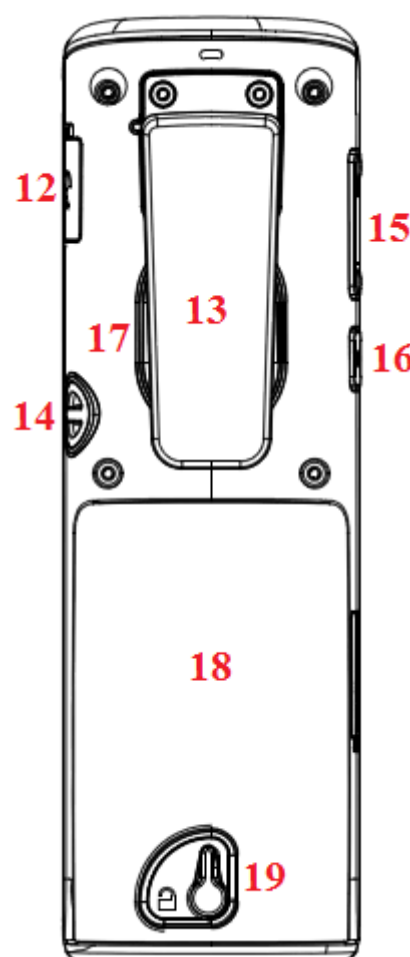

4 Display

This section contains a description of the different icons seen in the idle and in the menu.

4.1 Icons and Text in the Display

All functions and settings available to the handset user are shown as icons and text in the display. The icons and text in the display indicate functions and settings to which you have access.

The picture below shows a typical idle screen that displays the time and date, display name which is set on the web interface of the base station, registration number, and handset name which is set locally on the handset. This active area is also the area for dialog window text if there has been a missed call, or an action needs to be confirmed.



In the softkey bar at the bottom of the idle screen it is possible to access from the left: Contacts, Central Directory, and Calls.

The status bar at the top of the idle screen is always visible in all screens. This displays icons which give the user information about signal strength, missed call, new message, phone lock, key lock, sound off, time, and battery status. These icons are shown and explained shortly in the following:

 "Signal strength" icon is always visible in the upper left corner. The number of green staples is displayed according to the strength of the signal.

 "Battery" icon is always visible in the upper right corner, and shows how much battery that is left on the handset.

 "Full battery" icon is displayed when the handset is fully charged.

 This battery icon is displayed when there is 20% to 32% battery left on the handset.

 "Low battery" icon is displayed when there is 10% to 20% battery left on the handset.

 "Missed call" icon is displayed in the status bar, and indicates that there has been a missed call which can be seen in the call list.

 “Voice mail message” icon is displayed in the status bar when there are voice mails that have not been listened to. This icon remains until the voice mail has been listened to.

 “Message” icon is displayed in the status bar when there are messages on the handset that have not been read.

 “Bluetooth Enabled” icon is displayed when Bluetooth is enabled on the handset, but the handset is not paired with any Bluetooth device.

 “Bluetooth Enabled and Paired” icon is displayed when the handset is paired with a Bluetooth device.

 “Alarm” icon is displayed in the status bar and indicates that an alarm has been set on the handset.

 “Silent Alarm” icon is displayed in the status bar when the handset is in silent mode, or if the volume is set to the mute and an alarm is enabled.

 “Sound off”/”Silent” icon is displayed in the status bar when silent mode is enabled on the handset.

 “Keylock” icon indicates when the keypad is locked, and the user needs to long press the *-key to be able to use the handset again.

 “Do not disturb” icon is displayed in the status bar when this feature is enabled; in this case the handset does not react on any incoming calls.

HD “HD” icon is displayed during a call if the quality of the call is “High Definition” and hereby using the 722 codec (also called a wideband call).

4.2 Menu icons

All the menus available on the handset are displayed when the menu key is pressed from idle. The available menus are seen in the screen below.

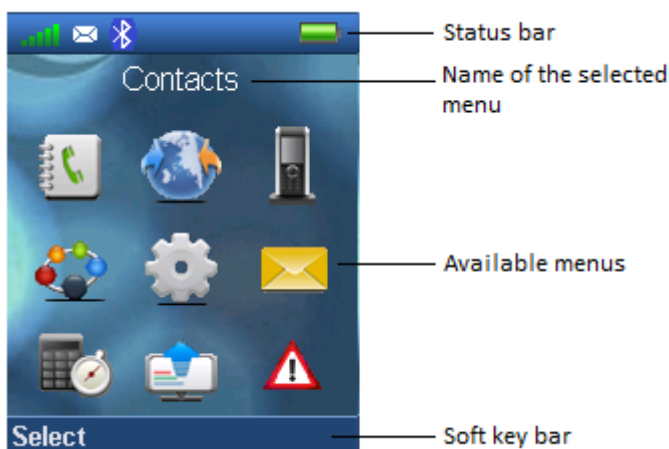

The status bar at the top of the display is always displayed independent of which menu is selected, and the softkey bar gives the possible options to select in every menu. In the active area of the screen the name of the menu selected is displayed at top, and all the available menus to select are displayed.

During navigation across the different menus the highlighted icon is moving to indicate where the navigation key is. The menu icons are showed and shortly explained in the following:



The “Contacts” menu contains all names/numbers in the local phonebook.



The “Central directory” menu contains all names/numbers in the central directory of the system. This is set up in the web interface of the base system (see the additional base station manual document for further information on this via [3])



The “Calls” menu contains call lists and call times.



The “Connectivity” menu contains options to register/deregister the handset and network options.



The “Settings” menu contains personal handset settings such as time/date, language, handset name, etc.



The “Messaging” menu contains messages received on and sent from the handset along with the available messaging settings.



The “Alarms” menu contains personal handset settings for the alarm.



The “F-Keys” menu contains personal handset settings for the F-Keys.



The “Alarm List” menu contains alarms received on the handset

4.3 Keys and Buttons

4.3.1 Navigation Keys/Selection Key

Use this key when navigating in menus, and to move the cursor when writing some text or a number.

The navigation keys  are used for stepping left/right and up/down when navigating in the menus. When selecting or entering a menu use the selection key in the middle of the navigation keys.

4.3.2 Softkeys

The handset has three softkeys  located just beneath the display, and the function of these is indicated by text in the display just above each softkey according to the respective screen.

4.3.3 Speaker Key

The speaker key  is used to shift between speaker mode and normal mode during call. When the handset is set to speaker mode during call the speaker key lights up in red, and the sound comes from the speaker on the back of the handset.

4.3.4 Activity Menu Key

When using this key  from idle the activity menu is opened from which all the different menus available on the handset can be opened.

4.3.5 Off-hook Key

This key  is used for answering an incoming call, or dialing a number either directly from the idle, or from the contact list, call list, or central directory. Pressing this key in idle opens the call list.

4.3.6 On-hook, and On/Off Key

The On-hook key  is used for disconnecting calls, and returning to the previous menus when navigating in any menu. A long-press in idle will switch the handset off, and a long-press when the handset is switched off will switch the handset on.

4.3.7 Speed Dial Keys

Any key from “2” – “9” can be set as a speed dial key. A long press on any of these numbers when the handset is in idle can be set to a short cut to calling any contact in the contact list, or in the F-Key list. For additional information on this feature see *7.1.4 Speed Dial/On Touch Dial*.

4.3.8 Volume Button

These two volume buttons placed on the upper left side of the handset are used for increasing/decreasing the volume during a call.

NOTE: These buttons are used to control the volume when using the earpiece, a headset, and the loudspeaker. The lowest volume will not mute the handset.

4.3.9 Mute Button

The mute button is placed under the volume buttons on the left side of the handset. This button is used during call to mute the call so that the microphone in the handset is turned off, and the counterpart cannot hear you, but you are still able to hear the counterpart of the call.

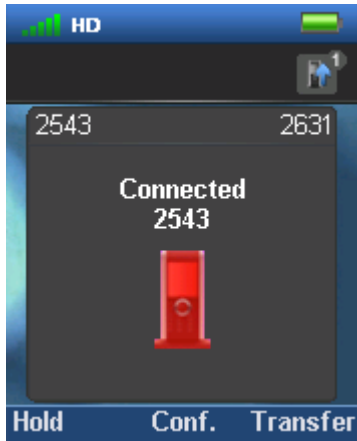

When the mute function is enabled during a call it is indicated on the “Connected” screen with the image of the handset that is red as seen above. Mute is turned off by pressing the mute button again.

4.4 The Keypad

The keypad is used when entering a name or number, and the sketch below shows the available characters on the handset.

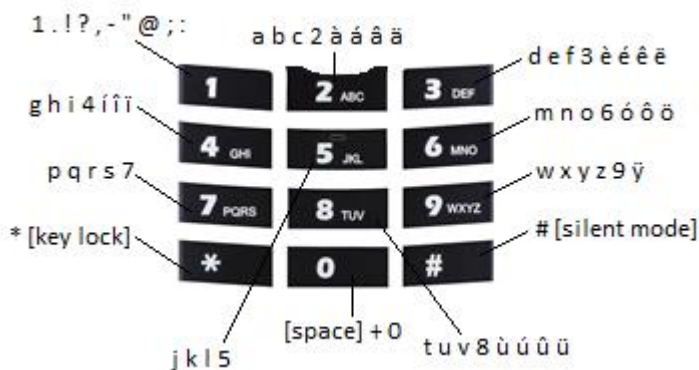

NOTE: Depending on the selected menu language, other characters can be available. Therefore the character order can differ from the table above.

4.4.1 Idle Mode, and Number Input Mode

When in idle a short press on a key enters the digits “0” – “9” and the characters * and #.

In number input mode, a long press on “0” generates a +.

4.4.2 In Text Input Mode

While in text input mode a short press on a key 0-9 displays the first available character on that specific key. The marked character is then selected after a timeout, or when another key is pressed.

By pressing the *-key it is possible to change the text to be upper/lower case or only numeric (Abc, abc, ABC, or 123).

Use the 0 to add a space in the text.

4.4.3 Silent Mode from #-Key

By long-pressing the #-key when the handset is in idle, the handset will turn to silent mode, and a “Sound Off” icon  will be shown in the status bar. This feature enables that the user rapidly can turn on silent mode. To turn off silent mode again long press the #-key in idle, or enter “Audio settings” and disable the “Silent” profile.

NOTE: When this mode is enabled it is possible to switch on the vibrator on the handset in Audio Settings > Vibrator (see 7.6.3 *Vibrator* for further information). Please note that all the other audio settings will be greyed out when the handset is in this silent mode.

5 Basic Operation

The following explain three basic operations of the handset: How to switch the handset on/off, how to lock/unlock the keypad, and the available options when entering a number in idle.

5.1 How to Switch the Handset On/Off

Switching on the handset

To switch the handset on long press the on-hook key  to switch the handset on. When the handset is on, it will display “Searching” for a short while until a signal is detected, and then the handset is showing the registration number and is ready for use.



Switching off the handset

To switch the handset off return to the idle screen and long press the on-hook button , and the handset will turn off.

5.2 Lock/Unlock the Keypad

To prevent accidentally pressing keys and making a call the keypad can be locked.

Locking the keypad

To lock the keypad long press the  in idle, and a text message is displayed “Press and hold *”. When the keypad is locked, the “Key Lock” icon  is displayed in the status bar.

Unlocking the keypad

To unlock the keypad long press  until the text message “Press and hold *” disappears.

NOTE: It is possible to answer/reject an incoming call while the keypad is locked.

5.3 Entering a number in idle

When entering a number in idle it is possible to call the number by pressing the off-hook key .

Otherwise, the following three different options are available when a number is entered in idle.

Save

With this option the number can be added as a local contact by pressing the left softkey “Save”.

Line

Using this option, by pressing the middle softkey “Line”, you can choose which line the call should be initiated from if the handset is set up to using different lines (see the base station manual for additional information on this; reference [3])

Clear

Using the right softkey “Clear” deletes one character at a time to the left of the cursor.

6 Menu Operation

In the following a description of the different menus and submenus on the handset will be given. Before the functions of every menu are explained a menu tree will be showed at top to give an overview of how to enter the different menus.

From idle it is possible to enter some of the menus directly via the three softkeys as displayed on the image below. By pressing the left softkey the menu 'Contacts' is entered, via the middle softkey 'Central Directory' is entered, and using the right softkeys enters 'Calls' to see the different calls lists.



To enter the menu from idle press the menu activity key  on the keypad, and all the different menus can be entered:



6.1 Contacts

In this menu all the local contacts on the handset are displayed. Below both a full and an empty local phonebook is displayed.

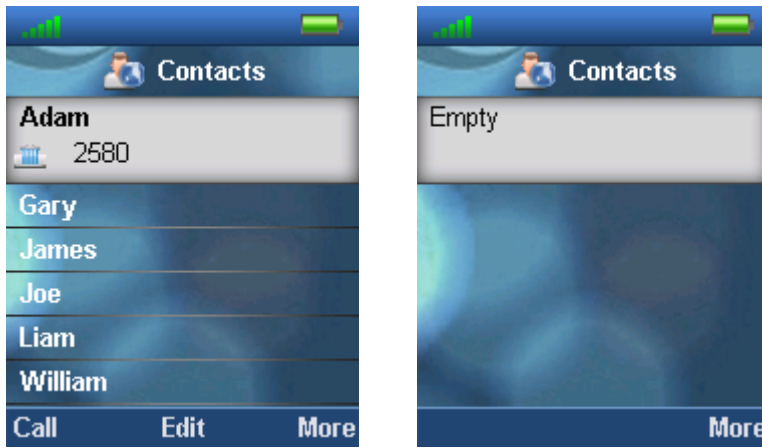

6.1.1 Add Contact

To add a new contact press the right softkey “More”, select “Add contact”, and the information displayed in the menu tree below can be filled out for the contact.

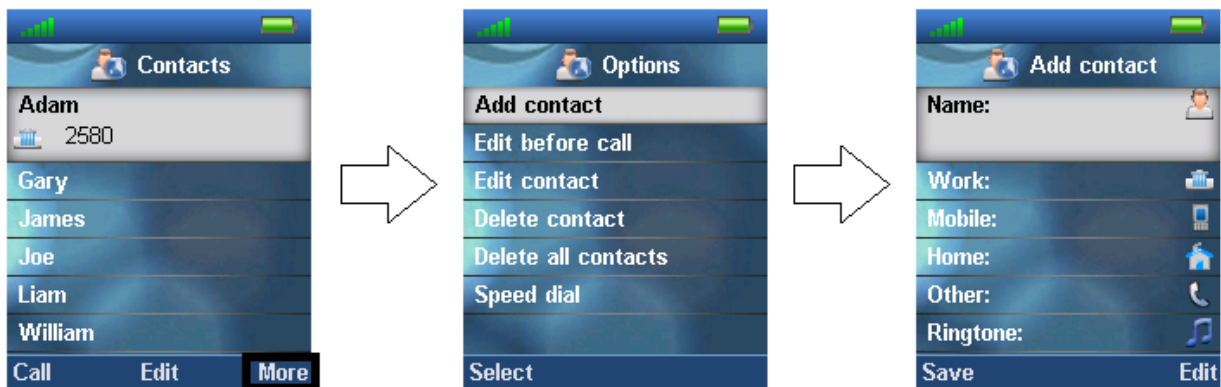

Hereby, it is possible to edit the name, add different phone numbers (work, mobile, home, and other), and add a specific ringtone to be used for exactly this contact.

To save a new contact, press the left softkey “Safe”.

6.1.2 Call/Edit a Contact

When the “Contacts” menu contains contacts it is possible to “Call” or “Edit” each contact with the left and middle softkey, respectively.



Pressing “Call” initiates a call to this contact.

When pressing “Edit” it is possible to edit the name, work, mobile, home, other, or ringtone for the highlighted contact.

6.1.3 More Contacts Options

When a specific contact is highlighted, pressing “More” in the “Contacts” menu enables the features seen below.

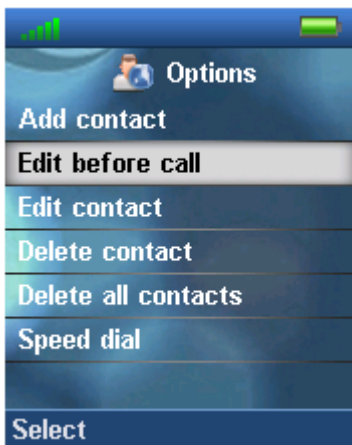

Edit before call

This function makes it possible to edit the number of the contact before calling the contact.

Edit contact

This has the same function as pressing “Edit” directly from the “Contacts” menu, and makes it possible to edit the name, work, mobile, home, other, or ringtone for the contact.

Delete contact

By selecting this feature, the following text message is displayed: “Delete current contact from local contact list?”

To delete the selected contact press the left softkey “Yes”.

To go back to the “More” menu, press the right softkey “No”.

Delete all contacts

With this function all the contacts in the local contact list can be deleted, and by selecting this option the following text message is displayed: “Delete entire local contact list?”

To delete all contacts in the local contact list press the left softkey “Yes”.

To go back to the “More” menu, press the right softkey “No”.

6.1.4 Speed dial/One Touch Dial

With this feature it is possible to add a contact to the speed dial. Hereby, this contact can be called directly from idle by long pressing the speed dial number that the contact is added to. The speed dial feature allows the user to assign a speed dial number (2 – 9) to a contact. This enables the user to call a contact by making a single long press on one of the number keys (2 – 9) when in idle.

A contact can only be assigned to one speed dial number at a time. The first defined number of the contact will be dialed when the speed dial key is pressed. This means that if all numbers (work, mobile, home, and other) are defined for the contact then the work number will be dialed. If the work number is not defined then the mobile number is dialed etc.

NOTE: The '1' key is reserved for voicemail. Long key press on '0' is used for starting a normal dial string with '+'.

6.1.4.1 How to setup speed dial

Prerequisite: There must be at least one contact in the contact list.

Steps:

1. Go to the contact list > Move to the contact that you want to assign a speed dial number to.
2. Select "More" > Select "Speed dial"
3. Move to the speed dial number (2 – 9) that you want to assign the contact number to.
4. Select "Add". The contact name should be appended to the speed dial number.
5. Leave speed dial list by pressing the red "On-hook" key > Press "On-hook" key to exit "More" menu > Exit contacts list by pressing "On-hook" key.

In the picture below it is showed how the local contact 'Adam' is added as a speed dial number to 2.

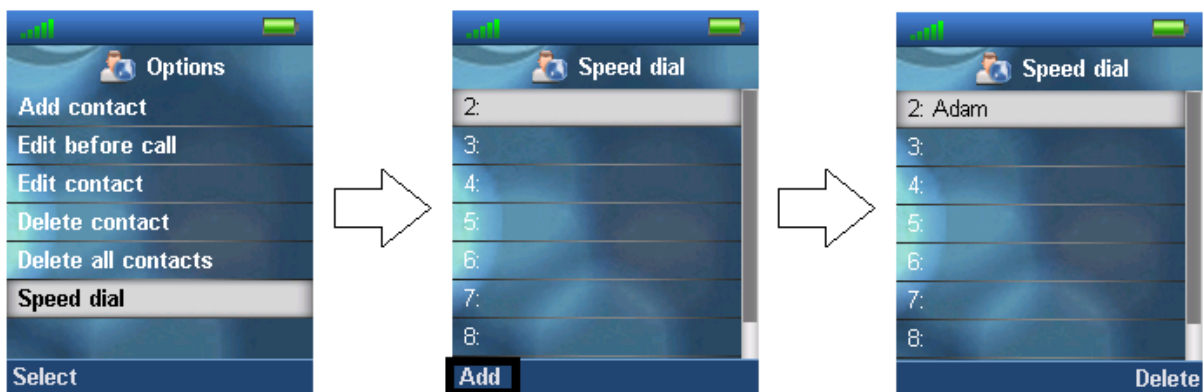

7.1.4.2 How to call a speed dial number

Prerequisite: The handset is in idle and the key lock is not active.

Steps:



1. Make a long key press (> 2 seconds) on a speed dial key that is assigned to a contact. The first number defined is dialed.

Hereby, the local contact 'Adam' can be called directly from idle by long-pressing  as displayed below:



NOTE: The speed dial function can also be set up for the F-Keys (for additional information on this see section 7.8 F-Keys)

6.2 Central Directory

In the “Central directory” menu different contacts can be called according to which list the system administrator has setup in the base system. This menu can be entered directly from idle with the middle softkey , or from the menu by pressing the menu activity key  and choosing “Central directory”.

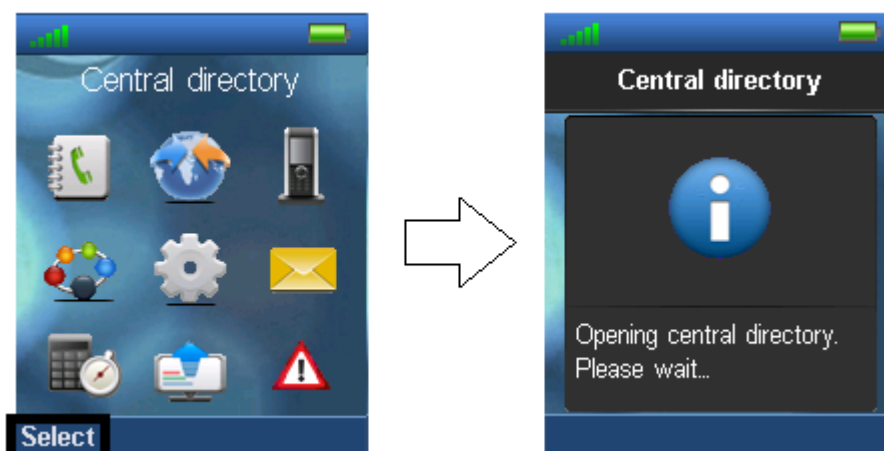

6.2.1 LDAP Mode and Local Mode

The “Central directory” can be set to LDAP Mode or Local Mode via the web interface of the base station (see [3] for additional information on this).

When set to LDAP mode, opening the central directory will show a search screen as displayed in the following. By leaving the search field empty and pressing the middle softkey “Search” all the contacts in the central directory will be displayed.

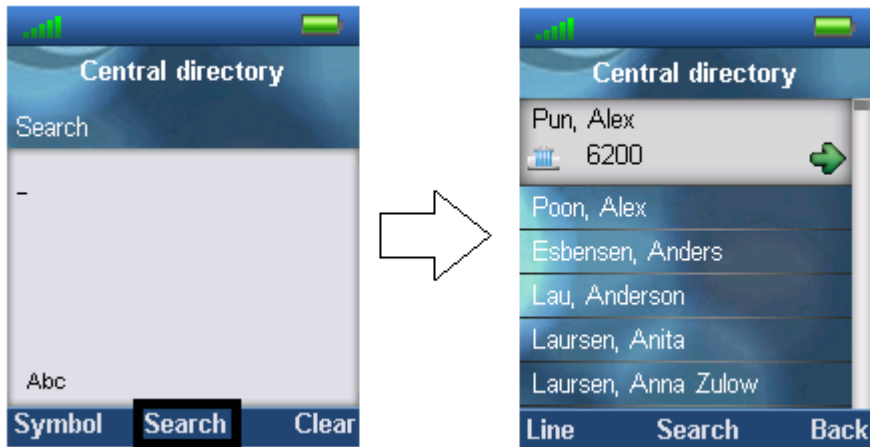

NOTE: When the central directory is in LDAP mode pressing right softkey “Back” the handset will return to the “Search” field, and a new search for a contact can be made. Pressing the red “On-hook” button, in the central directory, will send the user back to idle.

If the central directory instead of LDAP Mode is set to Local mode, opening the central directory will get you directly to browsing mode, and to enter the search mode press the middle softkey as displayed below.

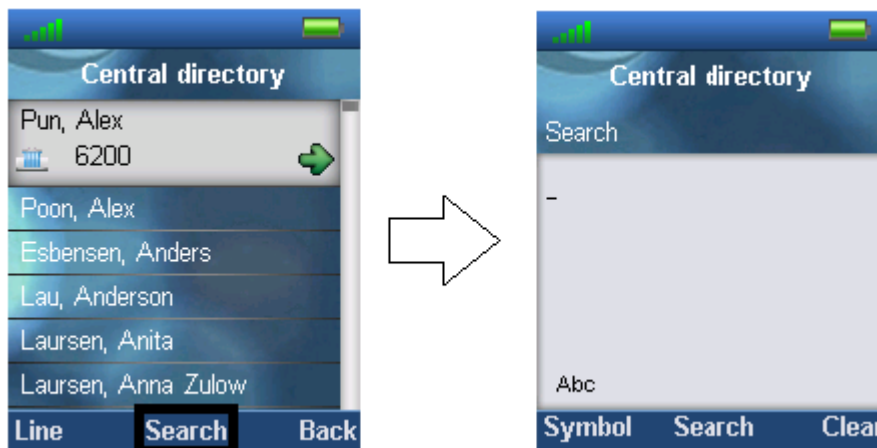

The search function is similar in these two modes. When typing something in the search field, and pressing search the results of the search will be displayed. This is showed in the following images.



To scroll through the search results use the navigation keys up and down and you will scroll through the list. If a green arrow is seen to the right of a contact (as seen above), this contact has more than one number added, and to scroll through these different numbers use the left/right navigation keys.

6.2.2 Calling a Contact in the Central Directory

To call a contact from the central directory press the green “Off-hook” button, and the contact number that currently appears on the screen will be called.

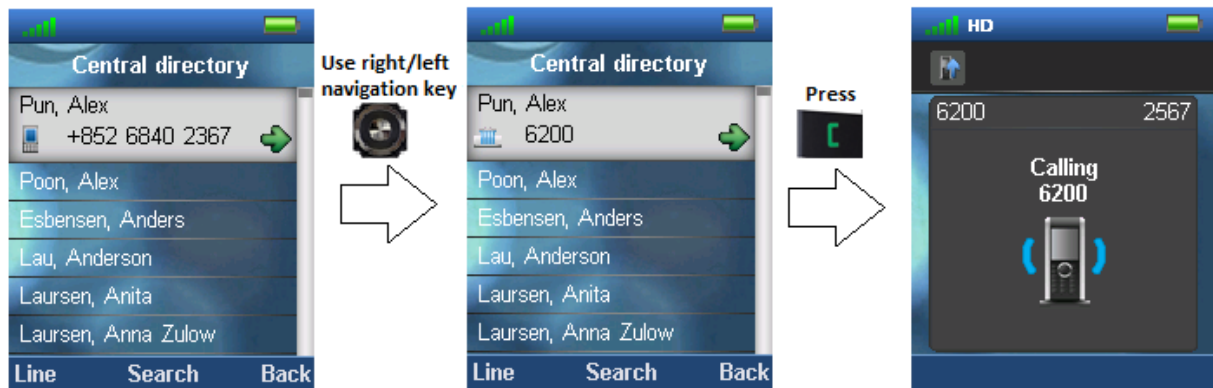

If a contact has more numbers added a green arrow is shown to the right of the contact, and by pressing the right/left navigation keys it is possible to navigate between the different numbers assigned to that contact. The number that currently appears on the screen is the one that is called

6.2.3 Line



By pressing the left softkey “Line” it is possible to choose different lines for the call to be made through as for example if the handset is assigned to different extension numbers, or to different PBX’s; as illustrated in the picture below. By choosing one of these different lines the call is then routed through the selected one. The line that is set in Settings > Line is used as default.



To see additional information on this “Line” feature, and more about the “Central Directory” setup on the base station please check the user manual for the base station; reference [3].

6.3 Calls

The menu “Calls” consists of lists of all the calls that have been made to or from the handset.

This menu can be entered directly from idle with the right softkey , by pressing the green off-hook button  or from the menu by pressing the menu activity key  and choosing "Calls".



When opening the "Calls" menu, the list "All calls" is automatically opened.

Using the left/right navigation keys  it is possible to view the four different lists.

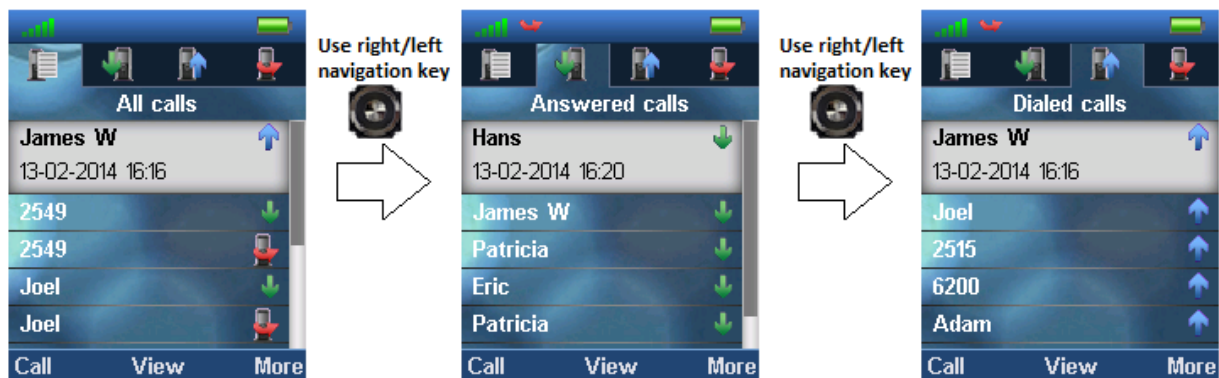

All calls: This list consists of all the different call types (including both outgoing and incoming) that have been made on the handset.

Answered calls: This lists all the incoming calls that have been answered.

Dialed calls: All the calls that have been dialed from the handset are listed.

Missed calls: This lists all the incoming calls to the handset that have not been answered.

When there is a missed call on the handset a red icon  is displayed in the status bar until the entry has been displayed in the missed call list. As shown in the images below, the information displayed about the missed call in the call list is in bold text until the entry has been scrolled over once.

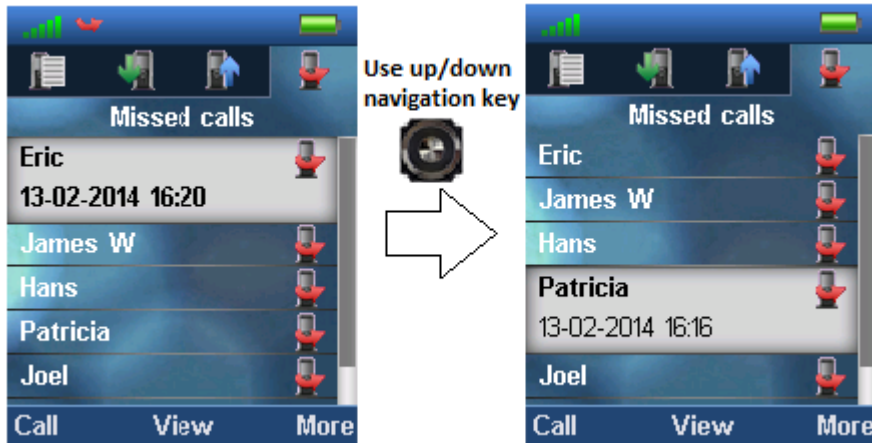

Using the up/down navigation keys scrolls through the list of missed calls. When the entries has been displayed once, the text displaying call information is no longer bold, and the red missed call icon disappears from the status bar indicating that the user has seen missed call; this is displayed in the second image above.

6.3.1 Call

To initiate a call directly from the local call list use the up and down navigation keys to highlight an entry, and press the left softkey “Call”. This will initiate a call to the highlighted entry as display in the images below.



A call can also be made to the highlighted entry by pressing the green off-hook key .

6.3.2 View

The middle softkey enters a “View” function for each entry. With this feature the following details of the call can be seen: number, line number, status (answered, dialed, missed), duration, and time stamp as displayed in the image below.

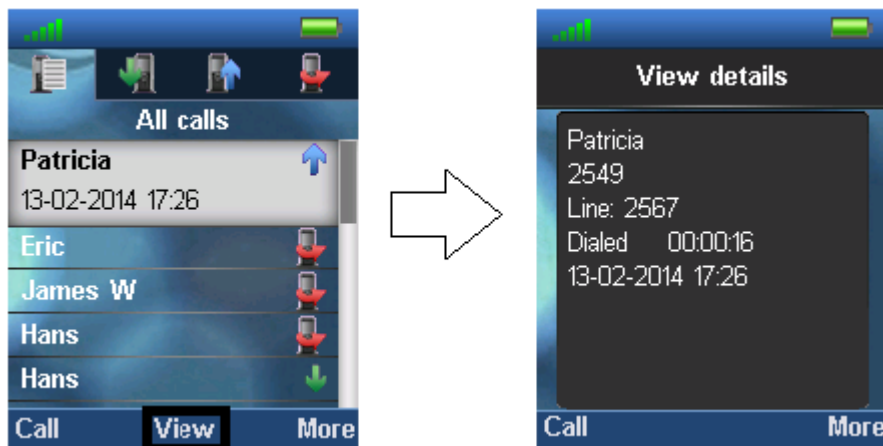

6.3.3 More Calls Options

When a specific call is highlighted, pressing “More” in the “Calls” menu enables the features seen below.

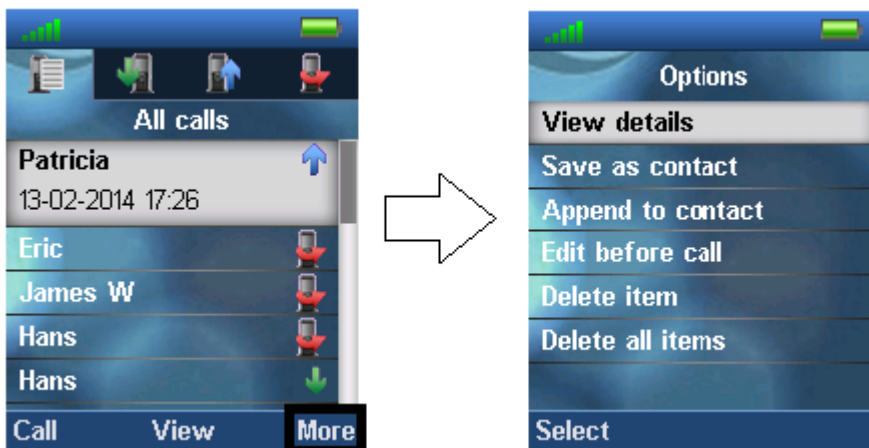

View details

This shows the same details about the call as the “View” function explained in 7.3.1 *Call/View*.

Save as contact

With this feature it is possible to save the number in the call list as a contact.

Append to contact

This function makes it possible to add the number in the call list to an existing contact.

Edit before call

With this function the number in the call list can be edited before calling.

Delete item

By selecting “Delete item” the following text message is displayed: “Delete current item from list?”

To delete the item from the call list, press the left softkey “Yes”.

To return to the call list, press the right softkey “No”.

Delete all items

This feature makes it possible to delete all items in the specific call list. By selecting “Delete all items” the following text message is displayed: “Delete all items in this list?”

To delete all items in the specific list, press the left softkey “Yes”.
 To return to the call list, press the right softkey “No”.

6.4 Connectivity

The “Connectivity” menu is entered in the menu by pressing the menu activity key  in idle.

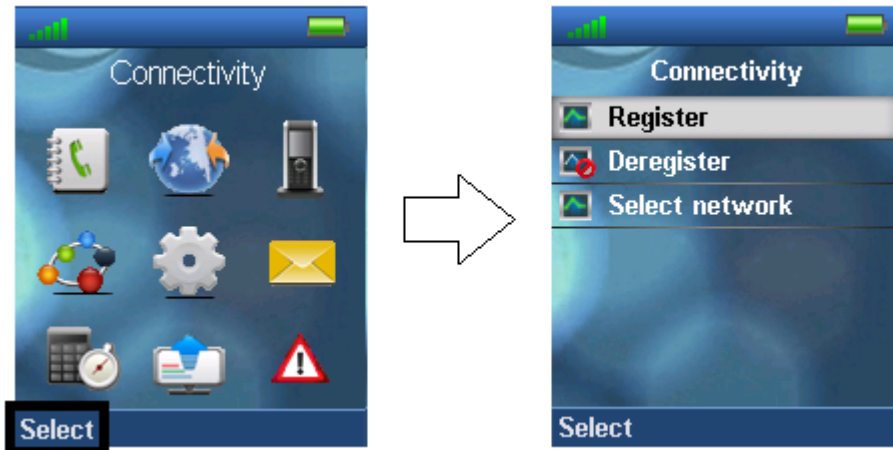

In this menu it is possible to register or deregister the handset to a certain base system. Moreover, the “Select network” function makes it possible to register the handset to more than one base system.

6.4.1 Register

When a handset is to be registered on a base system, the user will be prompted for an access code (base registration PIN) before the registration procedure is started. Since it is possible for the handset to be registered on different base systems that are out of range of each other, the “Register” menu displays 10 different entries with which the handset can be assigned to different base systems. When selecting an “Empty” entry the user is prompted for the PIN code as shown below.

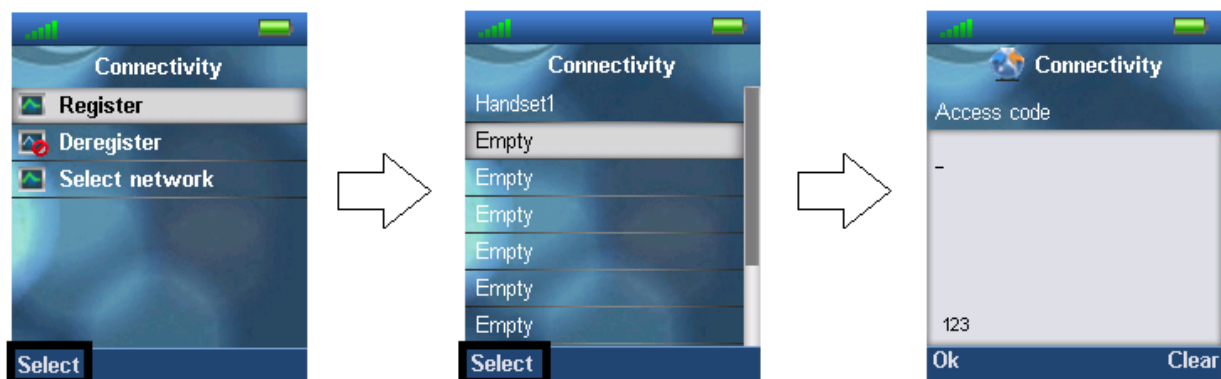

The access PIN code is default “0000” and cannot be changed via the handset. The access PIN code can only be changed via the web interface on the base (please check the additional document via [3] for more information about handset registration on a base system).

It is also possible to overwrite an existing registration by selecting that entry that should be overwritten instead of selecting an “Empty” slot. This is displayed below.

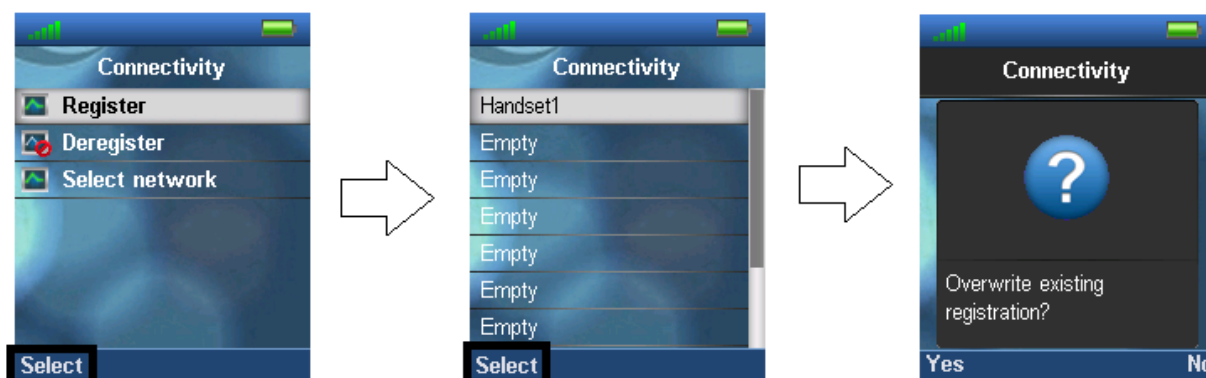

NOTE: For the handset to function on different base systems, the handset must be completely out of range of system 1 to connect to system 2.

6.4.2 Deregister

The handset can be deregistered from a registration. The user will in this case be prompted for a PIN code (base deregistration PIN), the PIN code is default “0000” and cannot be changed via the handset. This is displayed below.

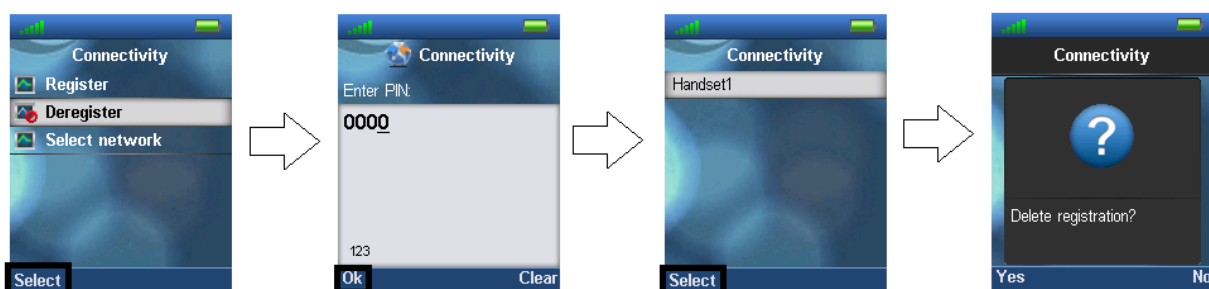

When the registration that should be deregistered is selected, a warning message “Delete registration?” will be displayed as seen above. The user then have to accept by pressing the left softkey “Yes”, or the right softkey “No” to cancel the operation.

6.4.3 Select Network

If the handset is registered to different base systems (networks) the preferred network can be chosen in this menu by highlighting it and pressing the left softkey “Select” as shown below.



For the handset to automatically select a network “Auto. select” can be selected. In this way, the handset automatically chooses the network in range.

6.5 Settings

The “Settings” menu is entered through the menu by pressing the activity menu key  in idle.



The “Settings” menu contains the following personal handset settings:

Settings	Audio settings
	Time & Date
	Language
	LED Signal
	Power save
	Security
	Handset name
	Line
	Reset settings
	Status
	Auto answer
	Silent charging
	Do not disturb
	Hide number
	Call Forward
Idle screen saver	
Bluetooth	

Each of these settings will be described in the following.

6.5.1 Audio settings

The “Audio settings” menu contains different settings for the sounds on the handset.



6.5.1.1 Silent

The “Silent” profile can be either enabled with the right softkey “On”, or disabled with the left softkey “Off”. When the “Silent” profile is enabled no sounds are played on the handset, and the handset does not ring on incoming calls or messages.



In the Audio settings menu only “Ring emergency”, “Vibrator” and “Noise reduction” can be entered when the “Silent” profile is enabled.

NOTE: With the “Silent” profile enabled, a ring melody will still be played when the handset receives an emergency alarm message.

6.5.1.2 Ring Volume and Ring Melody

When the handset receives an incoming call, message, or alarm different ring volumes and melodies can be selected.

Ring volume

The ring volume for calls can be adjusted from mute to volume 6. The currently applied level is displayed when entering the menu “Ring volume”.

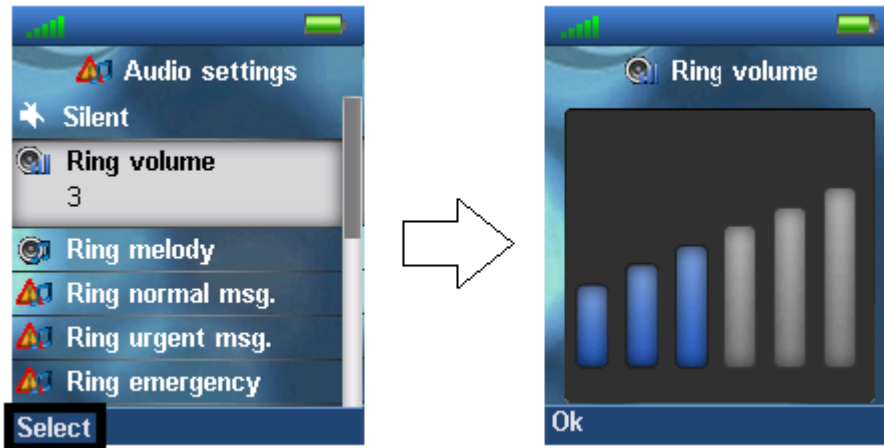

To select the desired ring volume the navigation keys up/down or right/left is used to respectively increase or decrease the volume. Thereby, pressing “Ok” saves the current ring volume. The currently applied ring melody is played when adjusting the ring volume so that the respective ring volume can be heard before selected.

Ring mute

The ringer is switched off when the lowest level is selected in “Ring volume”, and a mute image is showed in the display as seen below.

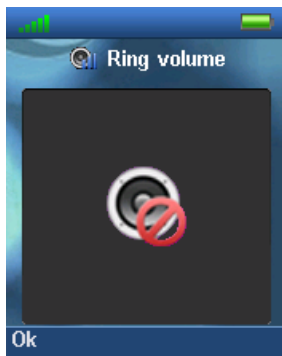

When the ring volume is set to mute, the “Sound off” icon is displayed in the status bar, and no sound is heard when receiving an incoming call.

Ring melody

Six different ring melodies can be chosen for the handset to play when receiving an incoming call. A list of melodies is displayed when entering the menu. Each displayed melody on the list can be selected by pressing the left softkey “Select”.



To hear the melody before selecting it, each melody in the list can be played by selecting the right softkey “Play”. The softkey “Play” changes to “Stop” during playback and the playback can then be stopped by pressing this button.

6.5.1.3 Ring normal and urgent message

The handset can receive messages with both a normal priority and an urgent priority. Therefore different ring melodies can be selected for each type of received message.

Ring normal msg.

In the “Ring normal msg.” menu it is possible to select the melody that should be played when messages prioritized as normal are received on the handset.

Ring urgent msg.

In the “Ring urgent msg.” menu it is selected which melody that should be played when the handset receives messages that is sent with urgent priority.

NOTE: The message ring melodies are played with the same ring melody as setup for incoming calls.

6.5.1.4 Ring emergency

With the “Ring emergency” menu it can be chosen which melody should be played when the handset receives an alarm message. The ring melody is chosen in the same way as the ring melody for incoming calls. For additional information on the handset alarm feature reference is made to chapter *6.9 Alarms List*.

6.5.1.5 Alert Volume and Alert Tone

When an alarm clock occurs on the handset, different ring volumes and melodies can be selected.

Alert volume

The alert volume can be adjusted from mute to volume 6. The currently used level is displayed when entering the menu “Alert volume”.

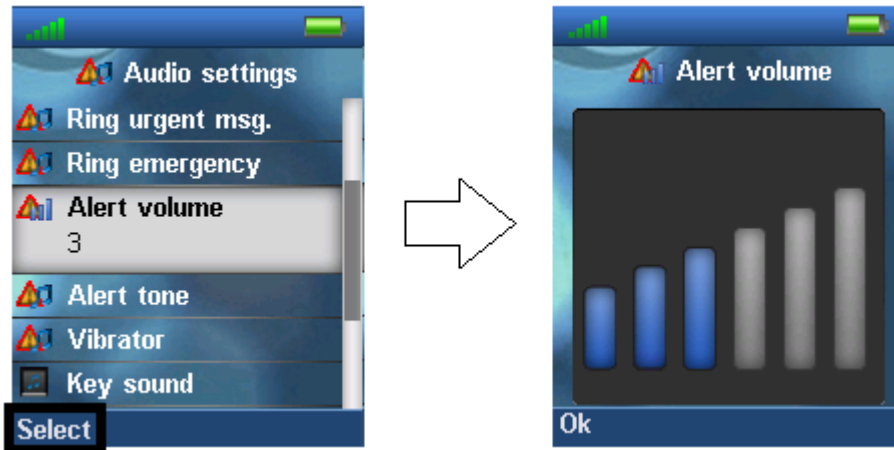

To select the desired alert volume the navigation keys up/down or right/left is used to respectively increase or decrease the volume. Thereby, pressing “Ok” saves the current alert volume. The currently applied alert melody is played when adjusting the alert volume so that the respective alert volume can be heard before selected.

Alert mute

The alert sound is switched off when the lowest level is selected in “Alert volume”, and a mute image is showed in the display. When the alert is mute, no audio is heard when an alarm occurs.

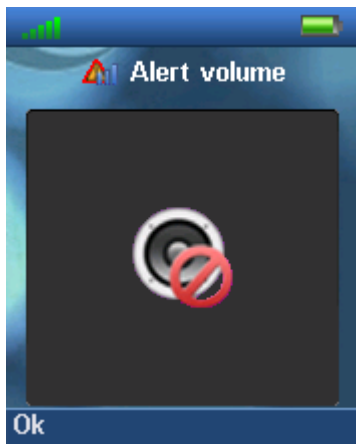

Alert tone

Six different melodies can be chosen for the handset to play when an alarm occurs. A list of melodies is displayed when entering the menu. Each displayed melody in the list can be selected by pressing the left softkey “Select”.



To hear the melody before selecting it, each melody on the list can be played by selecting the right softkey “Play”. The softkey “Play” changes to “Stop” during playback and the playback can then be stopped by pressing this button.

6.5.1.6 Vibrator

In the vibrator menu different vibrator options can be selected for the handset. The options for the handset vibrator are as showed and explained below.



Off

This function disables vibrator whereas the handset will not vibrate at incoming calls.

Vibrate then ring

If this function is enabled the handset will start vibrating during an incoming call, and then after four times of vibration the handset will stop to vibrate and only ring instead.

Vibrate only

With this function chosen the handset will only vibrate and not ring even though the ring signal is not mute.

Vibrate and ring

When this function is enabled the handset will both vibrate and ring at the same time when receiving an incoming call.

6.5.1.7 Key Sound

The “Key Sound” settings controls if a key sound is heard as the keys are pressed on the handset, or if no sound is made. The following three different options can be selected for the key sounds:



Silent

If this feature is chosen, there will not be heard any sounds when pressing the keys on handset.

Click

With this function enabled a click sound is heard when a key is pressed.

Tone

When this options is enabled a tone will be heard when a key is pressed.

NOTE: No key sound will be generated when pressing the keys during “key lock state” even though one of the options “Click” or “Tone” is enabled.

6.5.1.8 Confirmation Sound

This feature can either enable or disable confirmation sounds on the handset.

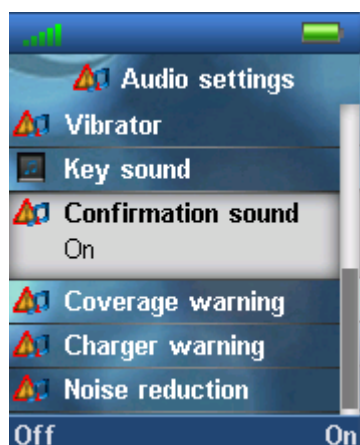

When the function “Confirmation sound” is enabled (On), an audible indication is given when an event succeed or fail.

For example a positive confirmation sound is generated when a new setting is set or an entry is saved successfully in the phonebook. A negative confirmation sound is generated if the action fails.

When the confirmation sound is set to “Off” no sounds is generated in either case.

6.5.1.9 Coverage Warning

A coverage warning can be set to occur when the handset is out of range of a base station in the system.

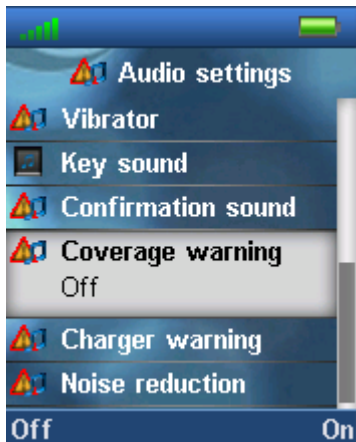

When the feature “Coverage warning” is enabled (On) an audible indication is given in the earpiece of the handset when the user is close to the maximum range of the nearest base station in the system. Hereby, the user knows that the call is at the edge of the possible coverage of the call, and that the user has to move back in to coverage to keep the call going.

NOTE: This feature is only working when the handset are in call. Not when in idle.

6.5.1.10 Charger Warning

“Charger Warning” is a feature that enables the handset to make a sound when put in the charger to indicate that the handset is charging.

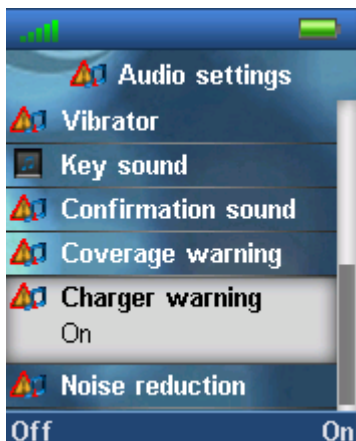

When the feature “Charger warning” is enabled (On), then an audible indication will be given when the handset is correctly connected to the charger.

If the feature is set to “Off” no audible indication will be given as the handset is put in the charger.

6.5.1.11 Noise reduction

In this menu, the feature “Noise reduction” can either be enabled by pressing the right softkey “On”, or disabled by pressing the left softkey “Off”.

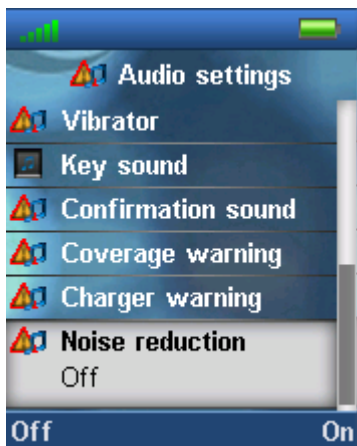

Noise reduction is a function used when the handset is in call. During a call if noise reduction is enabled on the handset, the background noise around the user is reduced. In this way, the user should sound clearer to the counterpart since the background noise is reduced to a minimum.

6.5.2 Time & Date

To set the time and date in the handset select the “Time & date” menu. Below it is shown how the time and time format can be changed.

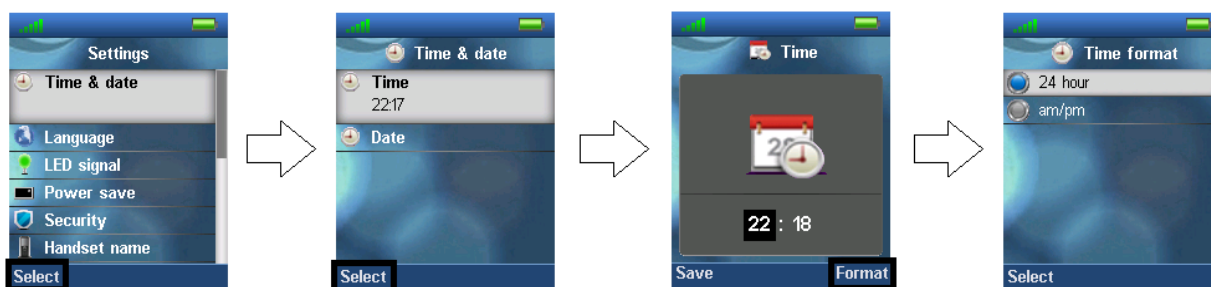

To change the time use the keypad, or the navigation keys to set the time to be what you want, and press save; as seen in the third image. The time format can also be changed by pressing the right softkey “Format”. In “Time format” the preferred time format (24 or 12 hours) can be selected.

In the same way the date can be changed as seen in the images below:

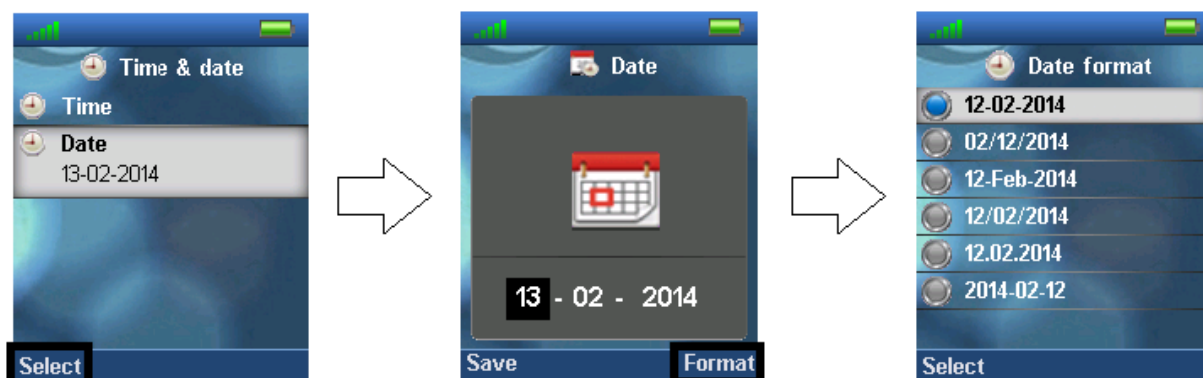

In “Date format” the preferred date format (i.e. dd-mm-yyyy) can be selected by using the up/down navigation keys.

6.5.3 Language

In this menu it is possible to select different languages for the handset. The menu tree below shows the different languages available on the handset.

Settings	Language	English
		Espanol
		Deutsch
		Francais
		Italiano
		Nederlands
		Portugues
		Dansk
		Svenska
		Turkce
		Polski
		Norsk
		Russian-1
		Russian-2
		Hrvatski
		Srpski
		Slovinsky
		Cesky

The currently applied language is displayed when highlighting the menu “Language”.



When entering this menu a specific language can be selected by pressing the left softkey “Select”.

6.5.4 LED Signal

The LED at the upper left corner of the handset has three different colours: green, yellow, and red. The different colours can be assigned to distinctive situations by the user.

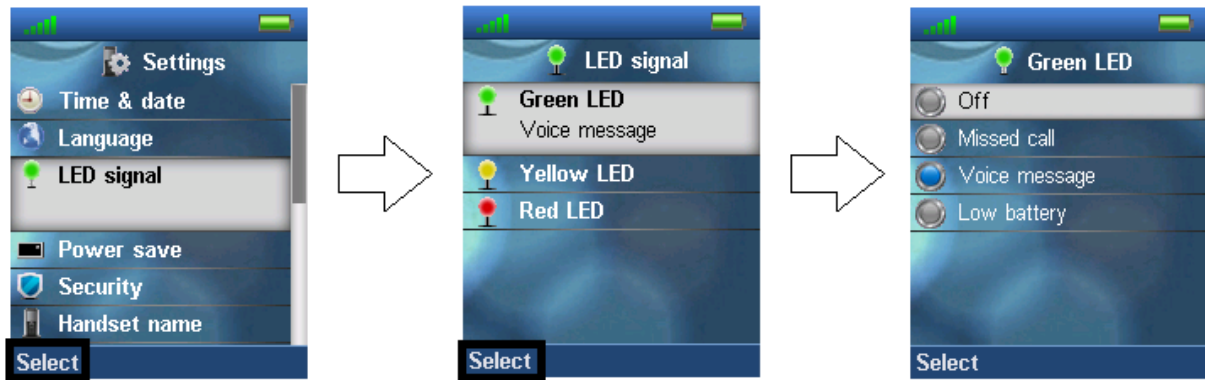

As seen in the images above each colour of the LED signal (green, yellow, and red) can respectively be configured to indicate:

Missed call

The LED signal blinks in the chosen colour when there is a missed call.

Voice message

The LED signal blinks in the chosen colour when there is a voice mail message that has not been listened to.

Low battery

The LED signals blinks in the chosen colour when the battery is low (below 20% battery on the handset).

Off

The LED signal is disabled, and does not blink in any situation.

6.5.5 Power Save

The power save option makes the handset less battery consuming by turning off the display after a certain amount of time.



In the images above it is displayed how the power save can be set between 5 seconds and 60 seconds. A certain time interval is chosen by pressing the left softkey “Select” when the desired time interval is highlighted.

6.5.6 Security

In the “Security” menu it is possible to set an automatic keylock, and change the PIN of the handset.

Automatic keylock

If the “Automatic keylock” feature is enabled, the keypad will lock automatically after a certain amount of time that the handset has not been used. The currently applied setting is displayed when highlighting the menu “Automatic keylock”.

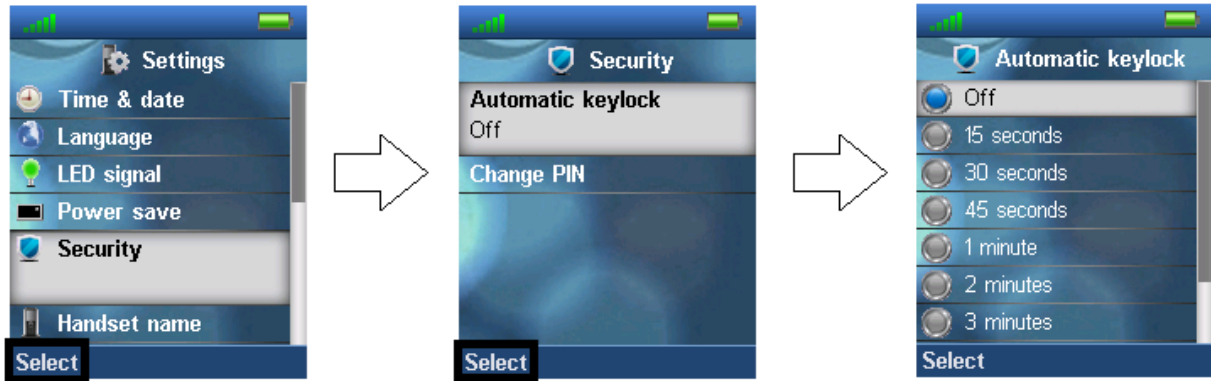

A list of selectable timeouts is displayed when the user enters the “Automatic keylock” menu. Any one of these can be selected by pressing the left softkey “Select” when the desired time interval is highlighted. Afterwards, when the handset has been inactive in the selected time interval the keypad will lock automatically.

NOTE: It is not possible to use the keys when these are locked. The user has to unlock the keys by long-pressing . Only emergency numbers (e.g. 911 or 112) can be called without the user having to unlock the keys.

Change PIN

In “Change PIN” the handset security PIN code can be changed – the PIN code is i.e. used when settings are reset.

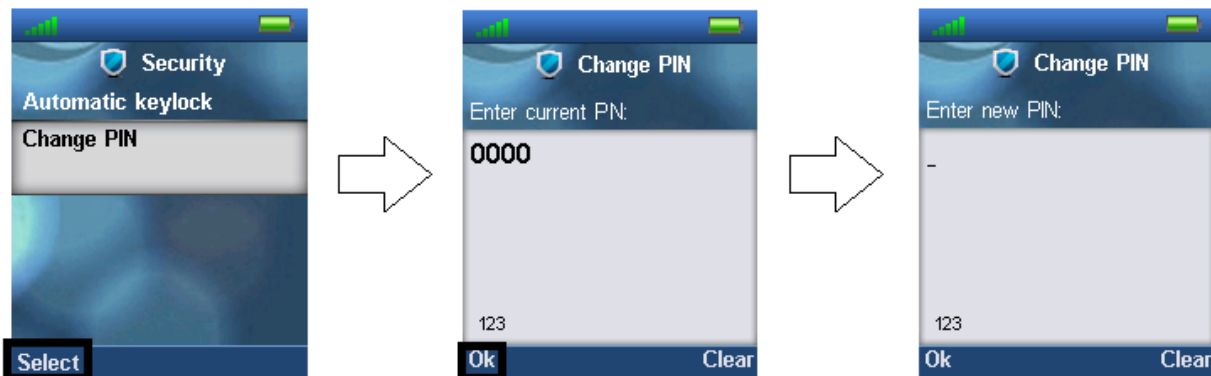

As seen above the current PIN code must be entered first to change it to a new PIN code.

6.5.7 Handset Name, Line, Reset Settings, Status

In the following settings, it is possible to change the handset name, select a line, reset settings, and see the status data from the base station.

Settings	Handset name
	Line
	Reset settings
	Status

Handset name

By selecting “Handset name” the name of the handset can be changed.



As seen above, an editor is displayed when entering the menu. The handset name is typed in by using the numeric keys and afterward pressing the left softkey “Save”. The handset name is displayed in the third line of the idle display.

Line

If the handset is used in a multiline environment, it is possible to select preferred lines for the handset to make outgoing calls from in this “Line” menu as shown below.



NOTE: To see additional information on this “Line” feature, please check the base system document via [3].

Reset settings

The handset settings can be reset to default settings by selecting menu “Reset settings”.

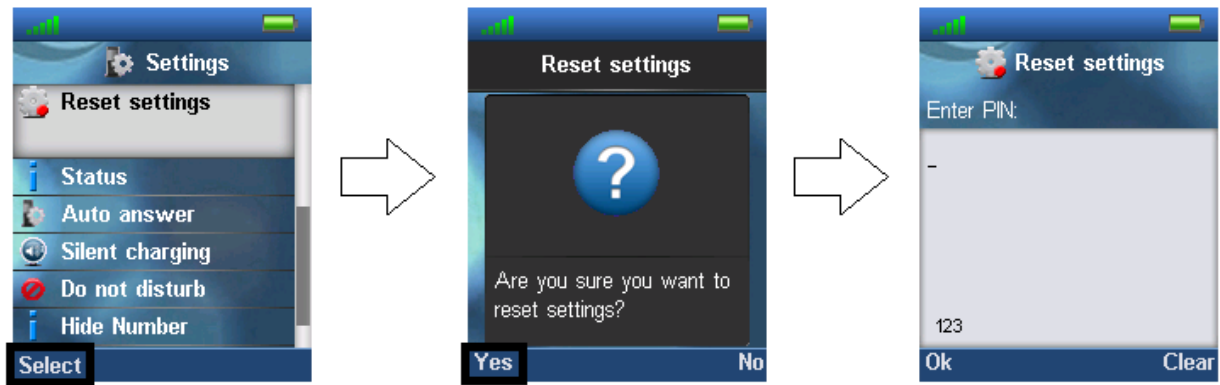

As it can be seen above, the handset PIN code is required to reset the handset to its default settings. After such a reset the handset is still registered. The base is not reset to default when selecting this feature.

Status

The menu “Status” delivers some useful information to the end user about both base station that the handset is currently using and handset status.

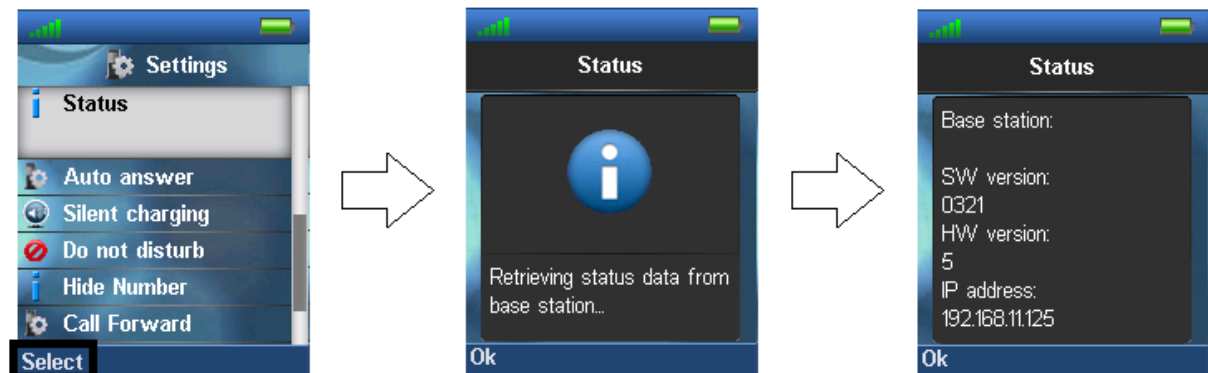

The displayed information is as follows.

Base station:

- Software version (the current software version of the base station)
- Hardware version (the hardware version of the base station)
- IP address (the IP address of the base station)
- MAC address (the MAC address of the base station)
- System name (the name of the system of base stations that the handset is registered to)

Handset status:

- Software version (the current software version of the handset)
- Hardware version (the hardware version of the handset)
- DECT band (the DECT band that the handset is using, e.g. EU or US)
- Battery level (the current battery level of the handset)
- IPEI (the IPEI/IPUI number of the handset is a static number identifying the specific handset)

6.5.8 Auto Answer

In this menu it is possible to change the settings for auto answer on the handset.



The “Auto answer” feature makes it possible for the handset to automatically answer an incoming call. This setting can be set to the following conditions:

Normal

With this enabled the handset does not answer a call automatically, but the user must always press the green “Off-hook” key to answer a call. The call is not answered by removing the handset from the charger.

Any key

In this mode pressing any key on the keypad (except from the red “On-hook” key, and the three softkeys that still have their different functions) will answer an incoming call. The call is not answered by removing the handset from the cradle/charger.

Automatic

If the feature “Automatic” is enabled on the handset, then the incoming call is answered automatically after 5 seconds.

6.5.9 Silent Charging

The option of “Silent charging” enables the possibility of the handset not ringing during charging. The handset must be placed in the charger in order for this to work as mentioned below. The options of silent charging are seen below.

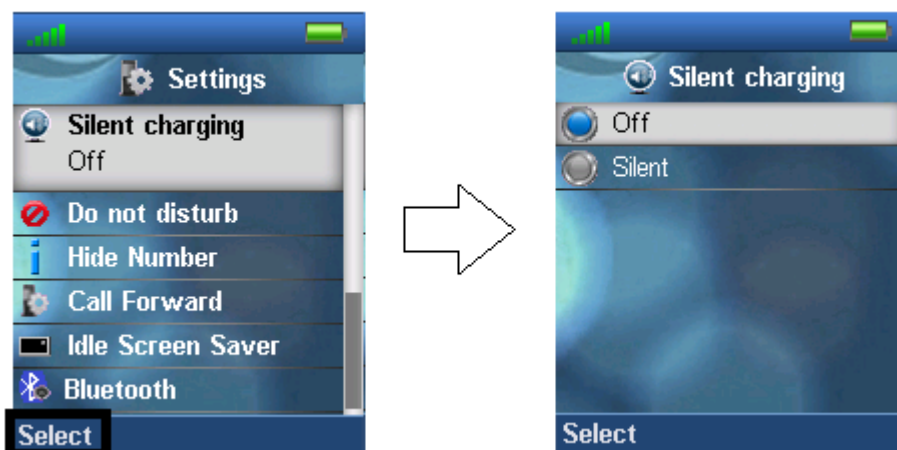

Off

The handset is ringing when receiving incoming calls (audio alert and incoming call screen displayed).

Silent

The handset receives an incoming call as normal, but it does not ring (i.e. no audio alert but the incoming call screen is displayed).

6.5.10 Do Not Disturb

This “Do not disturb” feature is to be used when the handset user does not want to be disturbed.

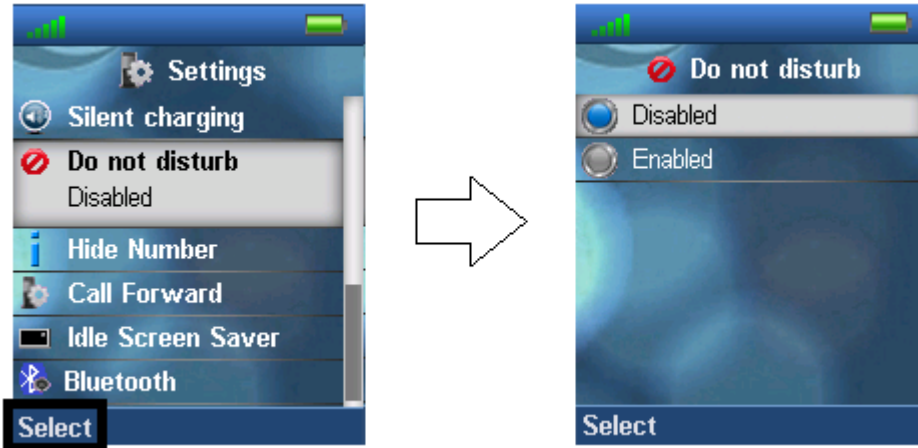

With this feature disabled, the handset reacts as normal on all incoming activity. If the function is enabled, though, the handset will not react, and the calling counterpart will be directed to voice mail if this feature is enabled.

The “Do not disturb” icon is displayed in the status bar when “Do not disturb” is enabled on the handset.

6.5.11 Hide Number

The “Hide Number” function enables that the user can make a call where the counterpart cannot see the caller ID of the caller.



Off

When the “Hide Number” function is set to “Off” with the left softkey, the caller ID of the handset is displayed to the counterpart of the call.

On for next call

If this function is enabled, then the caller ID will be hidden to the counterpart only for the next outgoing call, and then for the following calls the number will not be hidden anymore.

Always on

With the “Always on” enabled, the caller ID will be hidden for the counterpart for all outgoing calls initiated until this feature is disabled again.

NOTE: When hide number enabled, base sends SIP header “Privacy: id” to address sip:anonymous@anonymous.invalid

The PBX must support anonymous calls otherwise call rejected.

6.5.12 Call Forward

The “Call Forward” feature enables the user to forward all incoming calls in different cases described below.

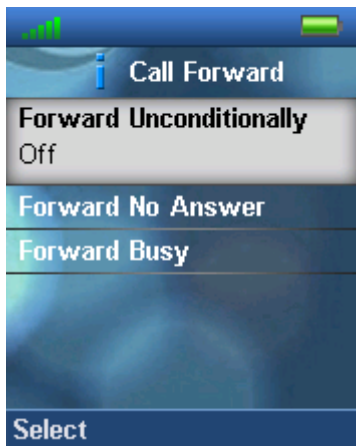

Forward Unconditionally

If this feature is enabled all incoming calls to the handset will be forwarded to the number setup in “Forward To” as seen below.

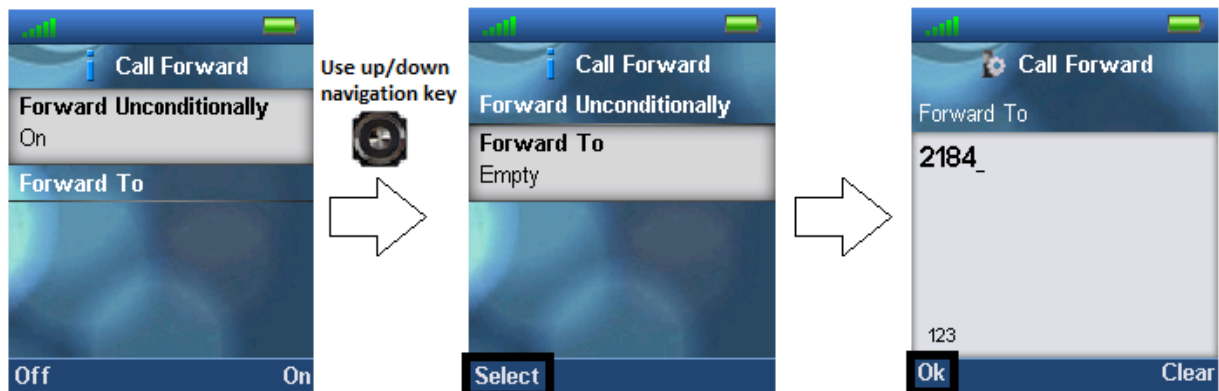

In this case the handset will not receive any incoming calls, but all calls will automatically be forwarded to the number setup in “Forward To”.

Forward No Answer

By enabling “Forward No Answer” incoming calls to the handset is forwarded if the call has not been

answered during a certain time period as for example 30 seconds. This feature is setup in the same way as “Forward Unconditionally” as displayed above.

Forward Busy

When “Forward Busy” is enabled the handset forwards all incoming call if the handset is busy, or if the user presses “Reject” on the call. This feature is enabled in the same way as “Forward Unconditionally” which is showed above.

6.5.13 Idle Screen Saver

The idle screen saver has the function that when the handset is in the charger, the handset screen will dim the lights, but never turn off if this feature is enabled.

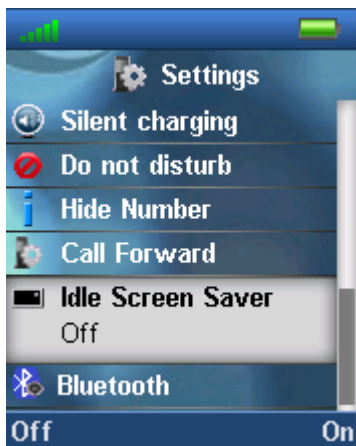

If the “Idle Screen Saver” is set to “On” with the right softkey, the screen will not turn off completely, but just dim the lights when the handset is in the charger.

The “Idle Screen Saver” can be set “Off” with the left softkey, whereas the screen will turn off completely after the power save, even with the handset placed in the charger.

6.5.14 Bluetooth



The Bluetooth feature enables the handset to be connected to a Bluetooth headset. When the handset is connected to a Bluetooth headset the audio on all calls is routed through the Bluetooth headset. When receiving an incoming call alerting is heard both from the handset and the paired Bluetooth headset.

6.5.14.1 Enable/disable

Bluetooth can either be enabled or disabled on the handset. The handset can only be paired with a Bluetooth device when Bluetooth is enabled. With Bluetooth enabled an icon is displayed in the status bar to indicate that Bluetooth is enabled on the handset.

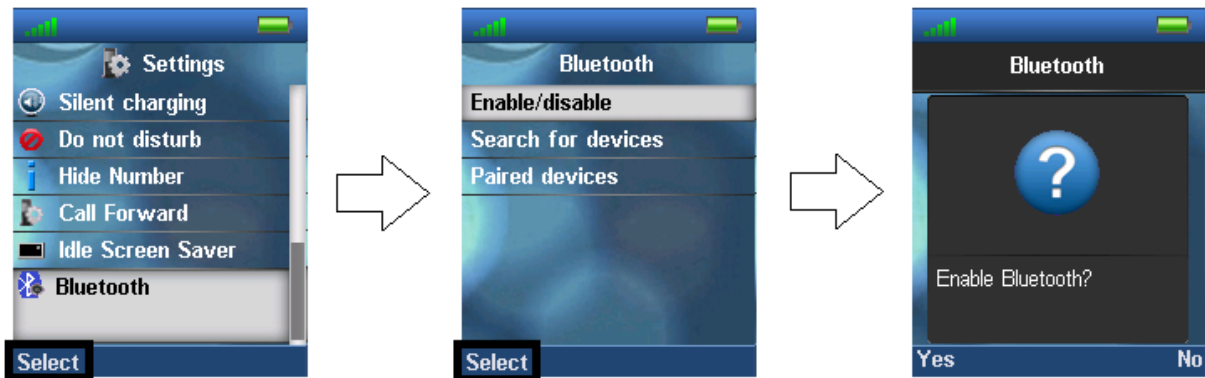

In the status bar, the Bluetooth icon is shown if Bluetooth is enabled, but the handset is not paired with any Bluetooth devices. This Bluetooth icon is displayed if the handset is paired with a Bluetooth device.

6.5.14.2 Search for devices

To search for Bluetooth devices the Bluetooth function needs to be enabled before the handset can find any devices. For the Bluetooth device to be found by the handset search it needs to be in pairing mode. Until the handset has found any Bluetooth devices in pairing mode a searching screen as displayed below is seen.



As it is seen above Bluetooth devices in pairing mode will be listed as they are detected by the handset. At first the ID of the Bluetooth device will only be shown, but waiting a little while the name of the device will appear on the handset screen. In this way it is easy to locate if it is the wanted device that the handset is about to connect to.

Often, a PIN code is requested when a device is selected. By entering the requested PIN code of the Bluetooth device a connection should be successfully established as displayed below.

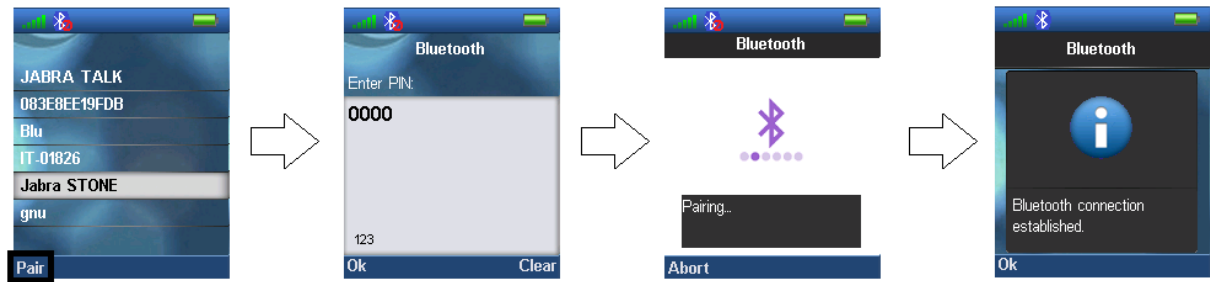

The handset is now connected to the Bluetooth device, and audio will be routed through the Bluetooth headset in call. To inform the user that the devices are paired a Bluetooth icon  is shown in the status bar.

6.5.14.3 Paired devices

The handset can be paired with up to four different Bluetooth headsets. When paired with one device this is displayed, as below, in the “Paired devices” list. By using the up/down navigation key the handset can be connected to any of the paired devices. The blue dot to the left of each device indicates which one of the devices the handset is connected to, and hereby through which the audio is routed when in call.

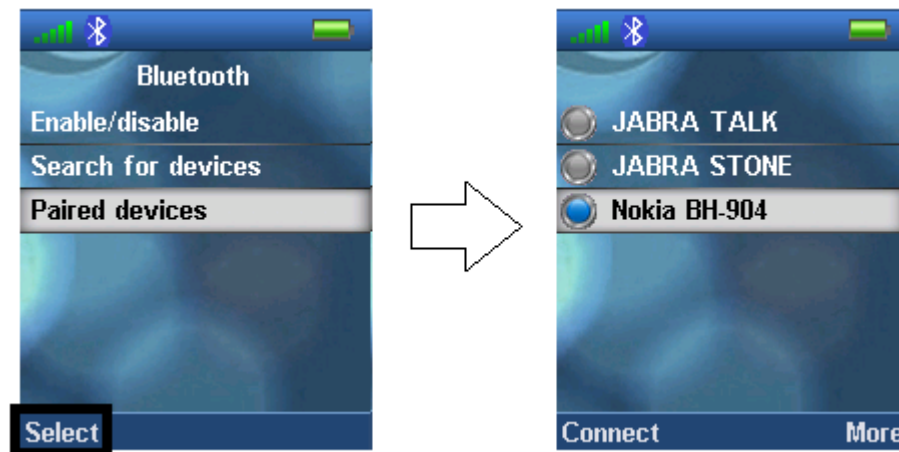

More

As displayed in the image below it is possible to select “More” in the “Paired devices” list by pressing the right softkey. The “More” option contains the following items:

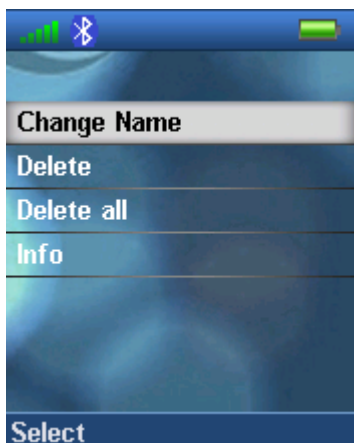

Change Name

This option changes the name of the paired Bluetooth device on the handset. In this way the handset user can change the name of the Bluetooth device to something other than the original name.

Delete

With this option the selected paired device can be deleted. If a paired Bluetooth device is deleted the handset will no longer be paired with this device and it will be removed from the “Paired devices” list.

Delete all

By selecting this option all devices in the “Paired devices” list can be deleted at once. If the all devices are deleted the handset will no longer be paired with any Bluetooth devices, and the  icon is displayed in the status bar.

Info

This options shows information about the paired Bluetooth device. The following information is displayed: *Status*, *Headset Name*, and *Headset Address*. An example of an information screen is displayed below:

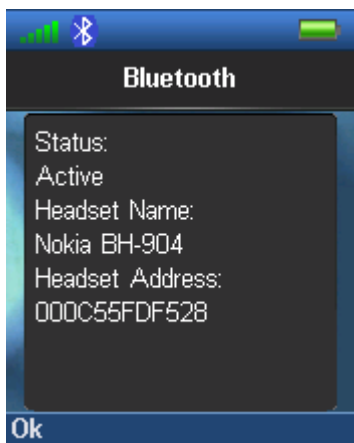

6.5.14.4 Bluetooth Headset Devices White List

The following types of headsets are on the white list for using with the RTX8830 Handset:

- Jabra Talk
- Jabra Stone
- Jabra Supreme
- Nokia BH-904

NOTE: The Jabra Supreme headset has the two features Jabra Voice Guidance and Jabra Voice Control. These two features, respectively, guides the user through using the headset, and makes it possible to control the headset hands-free by using voice control. These Jabra Voice features are both supported by the RTX8830 handset.

6.6 Messaging

The text messaging function makes it possible to send text messages to other handsets on the system.

From idle the text messaging menu is reached by pressing the menu activity key , and then selecting the ‘Messaging’ menu as displayed below.



6.6.1 How to Setup Text Messaging

For the text messaging function to work on the handset, this needs to be enabled on the base station web interface.

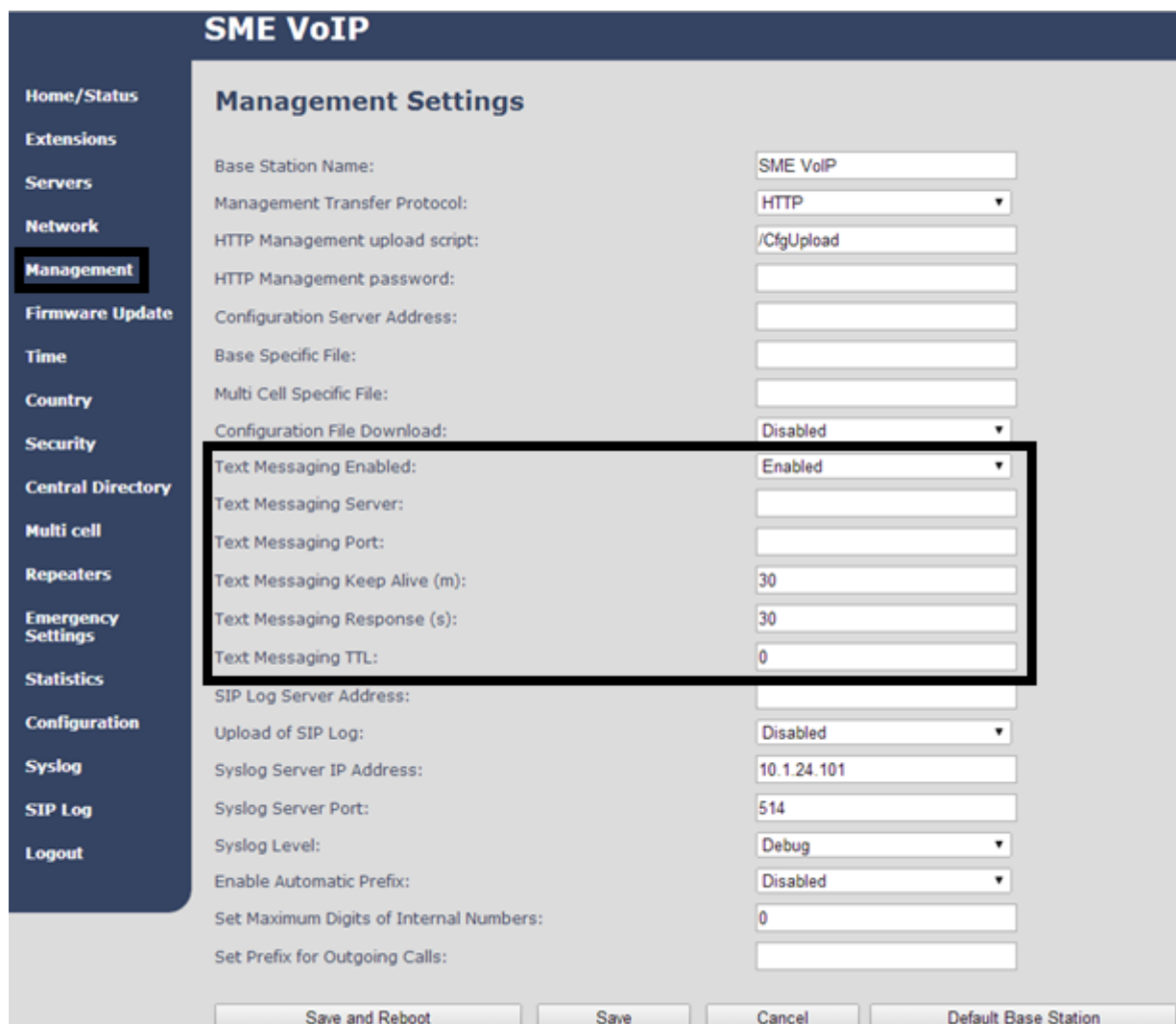

The image shows the "SME VoIP" web interface, specifically the "Management Settings" page. A sidebar on the left contains navigation links: Home/Status, Extensions, Servers, Network, Management (highlighted), Firmware Update, Time, Country, Security, Central Directory, Multi cell, Repeaters, Emergency Settings, Statistics, Configuration, Syslog, SIP Log, and Logout. The main content area is titled "Management Settings" and contains various configuration fields. A black box highlights the "Text Messaging Enabled" section, which includes:

- Text Messaging Enabled: Enabled (dropdown menu)
- Text Messaging Server: (empty text field)
- Text Messaging Port: (empty text field)
- Text Messaging Keep Alive (m): 30 (text field)
- Text Messaging Response (s): 30 (text field)
- Text Messaging TTL: 0 (text field)

Other visible settings include Base Station Name (SME VoIP), Management Transfer Protocol (HTTP), HTTP Management upload script (/CfgUpload), HTTP Management password (empty), Configuration Server Address (empty), Base Specific File (empty), Multi Cell Specific File (empty), Configuration File Download (Disabled), SIP Log Server Address (empty), Upload of SIP Log (Disabled), Syslog Server IP Address (10.1.24.101), Syslog Server Port (514), Syslog Level (Debug), Enable Automatic Prefix (Disabled), Set Maximum Digits of Internal Numbers (0), and Set Prefix for Outgoing Calls (empty). At the bottom, there are buttons for "Save and Reboot", "Save", "Cancel", and "Default Base Station".

As seen above the text messaging feature is enabled on the handsets via “Management” on the base station web interface. With this feature enabled it is possible to send messages from one handset on the system to another handset on the system. In this case, the “Text Messaging Enabled” just needs to be enabled, whereas the “Text Messaging Server” and “Text Messaging Port” should be left empty.

Additionally, it is possible to send the text messages via a text messaging server (MobiCall server) which enables handsets on different systems of base stations to send text messages to one another. When using a text messaging server for text messaging the “Text Messaging Server” and “Text Messaging Port” needs to be filled out. An example of this is seen below.

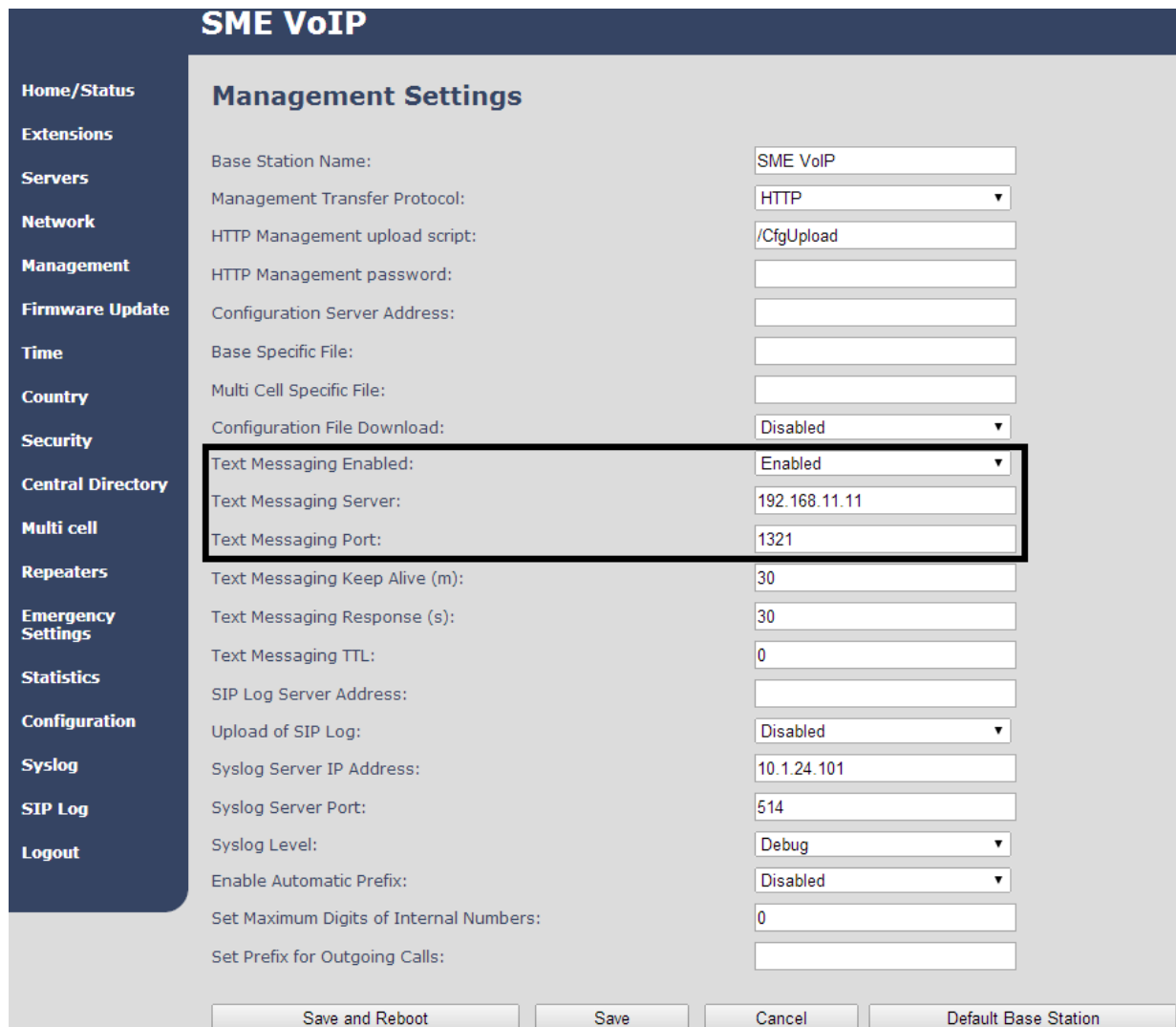

SME VoIP

Management Settings

Home/Status
 Extensions
 Servers
 Network
 Management
 Firmware Update
 Time
 Country
 Security
 Central Directory
 Multi cell
 Repeaters
 Emergency Settings
 Statistics
 Configuration
 Syslog
 SIP Log
 Logout

Base Station Name: SME VoIP
 Management Transfer Protocol: HTTP
 HTTP Management upload script: /CfgUpload
 HTTP Management password:
 Configuration Server Address:
 Base Specific File:
 Multi Cell Specific File:
 Configuration File Download: Disabled
Text Messaging Enabled: Enabled
Text Messaging Server: 192.168.11.11
Text Messaging Port: 1321
 Text Messaging Keep Alive (m): 30
 Text Messaging Response (s): 30
 Text Messaging TTL: 0
 SIP Log Server Address:
 Upload of SIP Log: Disabled
 Syslog Server IP Address: 10.1.24.101
 Syslog Server Port: 514
 Syslog Level: Debug
 Enable Automatic Prefix: Disabled
 Set Maximum Digits of Internal Numbers: 0
 Set Prefix for Outgoing Calls:

Save and Reboot Save Cancel Default Base Station

For further information on the text messaging feature and setup on the base station see the base station manual via reference [3].

6.6.2 How to Write a New Message

When opening the menu ‘Messaging’ the menu ‘Drafts’ is reached, and it is possible to write a new message by pressing the middle navigation key, or the middle softkey called “New”.

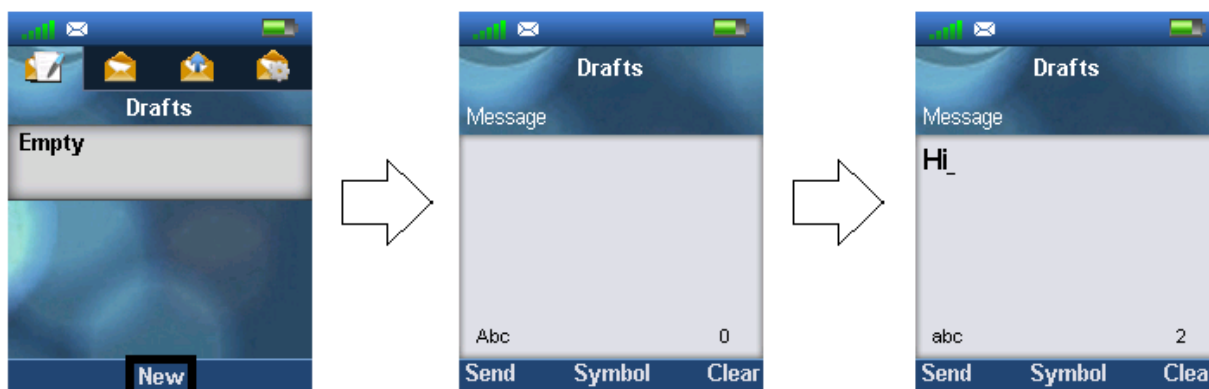

As displayed above, pressing 'New' makes it possible to write a new message by using the keypad. The maximal message text length is 160 characters, and the number of characters typed are displayed at the bottom right corner of the text field.

To choose other symbols than those available on the keypad press the middle softkey 'Symbol', and an amount of symbols will be available to select. If in need of deleting what has just been written the right softkey 'Clear' can be pressed, and the previous character is hereby deleted.

NOTE: Use the -key to switch between the input modes 'Abc', 'ABC', '123', and 'abc'.

6.6.3 How to Send a New Message

When a new message has been written, press the left softkey "Send" to send it.

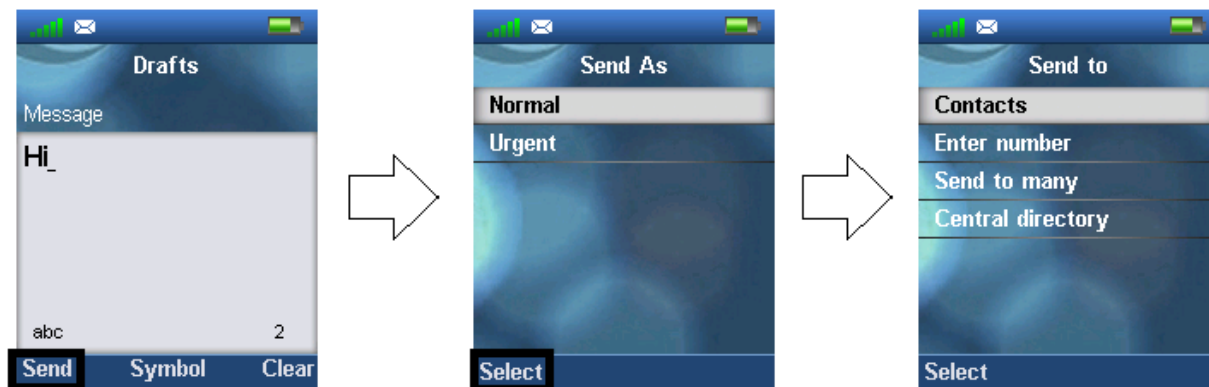

By pressing 'Send' two options are presented. The message can either be sent as 'Normal', or as 'Urgent'.

Normal

If a message is sent as 'Normal' the message is displayed as normal in the counterpart's inbox.

Urgent

When a message is sent as 'Urgent' the message is displayed with an exclamation mark in the counterpart's inbox, and with an exclamation mark in the 'Sent messages'. Urgent messages is always displayed at the top of the inbox.

Choosing either of these two options, four different possibilities are given as to who the message can be sent to as seen above.

Contacts

By selecting this option the contact list is displayed, and the message can be sent to one of the local contacts in the contact list.

Enter number

In this option it is possible to enter a number, and thereby sending a message to this number.

Send to many

By choosing 'Send to many' the message can be sent to more than one contact in the contact list without exiting from the list of contacts. This is displayed below.



In this way, when the message has been sent to one contact, the handset returns to the contact list, and it is possible to select another contact to send the message to immediately after the first one has been sent.

Central directory

Selecting the 'Central directory' option opens the central directory list of contacts, and makes it possible to send the message to contacts in this list.

6.6.4 How to Open and Reply to a Message

When a new message is received on the handset, the idle screen is displayed as seen on the first picture in the sequence below.



Press the left softkey to reply to the received message. The reply message can either be sent as 'Normal' or 'Urgent', and when choosing either of these two options the message is sent to the counterpart from whom it was received.

NOTE: When a new message is received, and has not yet been read the following message icon  is displayed in the status bar at top of the display.

6.6.5 Four Messaging Submenus

When opening the messaging menu it is possible to select the four submenus: Drafts, Inbox, Sent messages, and Settings. The submenus are organized in tabs whereby the left and right navigation keys

are used to navigate between them. The content of these four submenus are described in the following sections.

6.6.6 Drafts

'Drafts' is the submenu that is opened when the 'Messaging' menu is selected. In this menu drafts are saved if a message has been written, but was not sent.



When pressing select on a highlighted draft, this is opened according to the last time that it was edited, and it is possible to edit it, and send it again.

To write a new message press the middle softkey 'New' in this 'Drafts' menu (this function is described in more detail in section 6.6.2 *How to Send a New Message*)

6.6.5.1 The More Option

When pressing the right softkey 'More' in 'Drafts' it gives the three possibilities that is displayed and explained below.

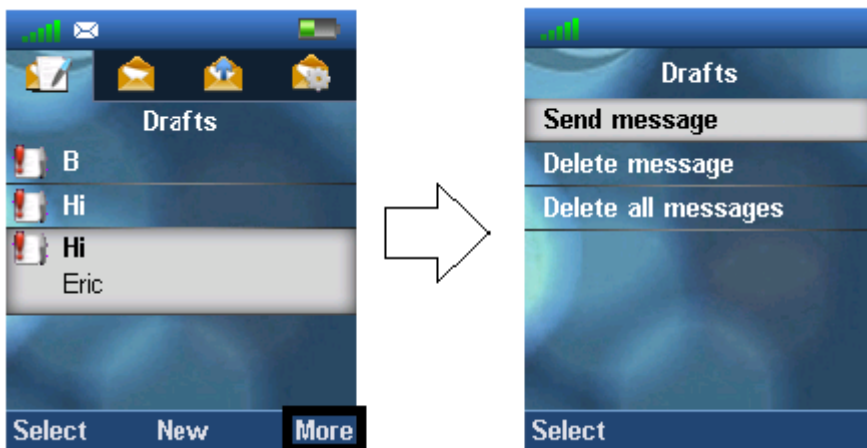

The option 'Send message' enters the message to edit and send. If 'Delete message' is chosen the current message can be deleted, and 'Delete all messages' gives the possibility to delete all messages in the 'Drafts' menu.

6.6.5.2 What is Stored in Drafts?

When writing a new message and then exiting with the red on-hook key before the message is sent, this message can be saved as a draft. This is displayed below.

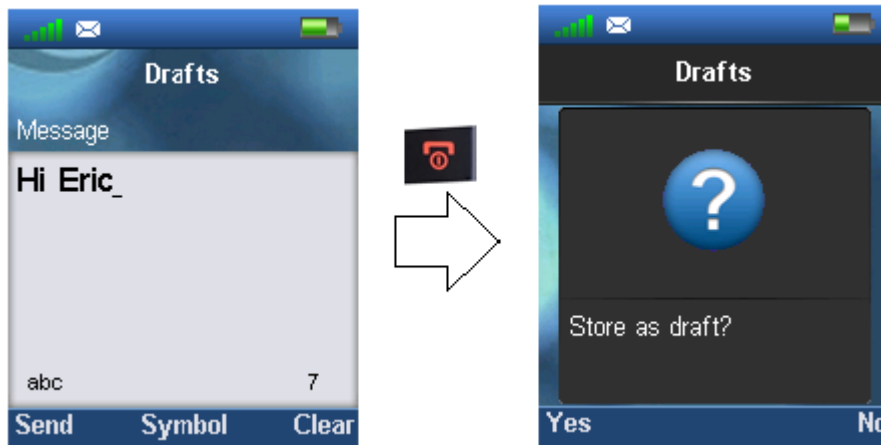

By pressing the left softkey 'Yes' the message is saved as a draft, and can be opened again in the 'Drafts' menu. If the right 'No' softkey is pressed the message is not stored as a draft, and the handset returns to the previously opened menu without saving the message.

6.6.7 Inbox

When pressing the right navigation key one time in the messaging menu, the submenu 'Inbox' is opened. This menu contains all received messages on the handset.

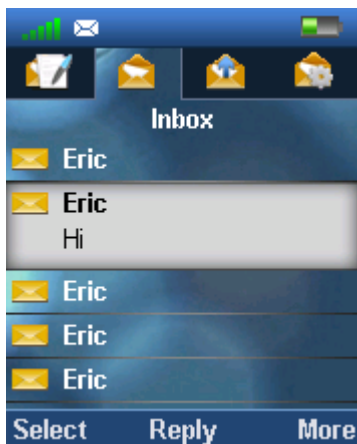

By pressing the middle softkey 'Reply' it is possible to reply to the highlighted message.

When selecting a highlighted message with the left softkey 'Select' this message is opened, and it is possible to use the left softkey to reply, or to enter the 'More' option described below directly from the message.

6.6.7.1 The More Option

The right softkey 'More' gives a list of options in the inbox which are described below.

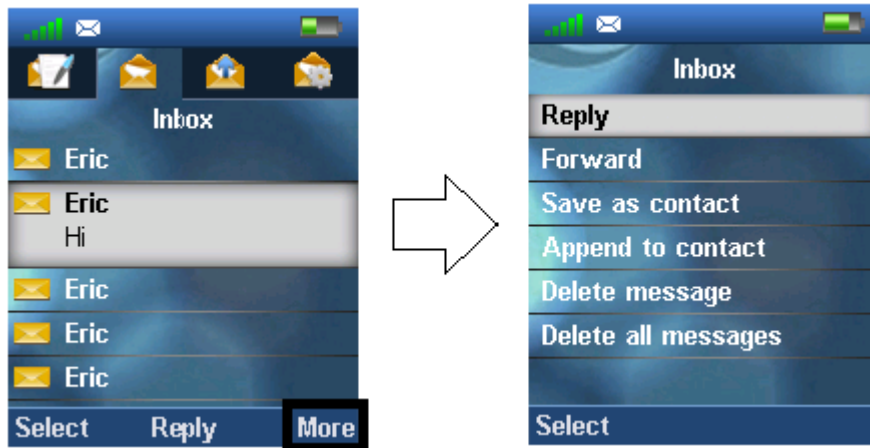

Reply

With this option it is possible to reply the counterpart to the received message.

Forward

By selecting 'Forward', the newly received message is entered again, and can be edited and forwarded to another number.

Save as contact

With the function 'Save as contact' it is possible to save the number that the message was received from in the local phonebook.

Append to contact

With the 'Append to contact' option it is possible to append the number that the message came from to an already existing contact in the local phonebook of the handset.

Delete message

By pressing 'Delete message' either 'Yes' can be pressed to delete the message, or 'No' can be pressed return to the 'Inbox' menu.

Delete all messages

This option gives the possibility to delete all messages in the messaging inbox, and a 'Yes' or 'No' option is given. By pressing the left softkey 'Yes' all messages in the inbox are deleted, by pressing the right softkey 'No' the handset goes to the message inbox.

6.6.8 Sent messages

In the 'Sent messages' menu a complete list of the messages sent from the handset is displayed.

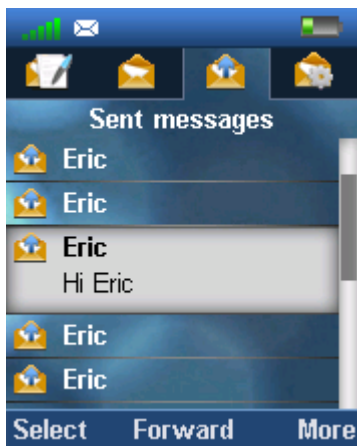

To open a sent message scroll up/down to highlight it, and then press the left softkey 'Select'. By pressing the middle softkey, the message is opened, and it is possible to forward it to another handset than it was originally sent to.

6.6.8.1 The More Option

When pressing the right softkey 'More' a list of options is given as seen below.

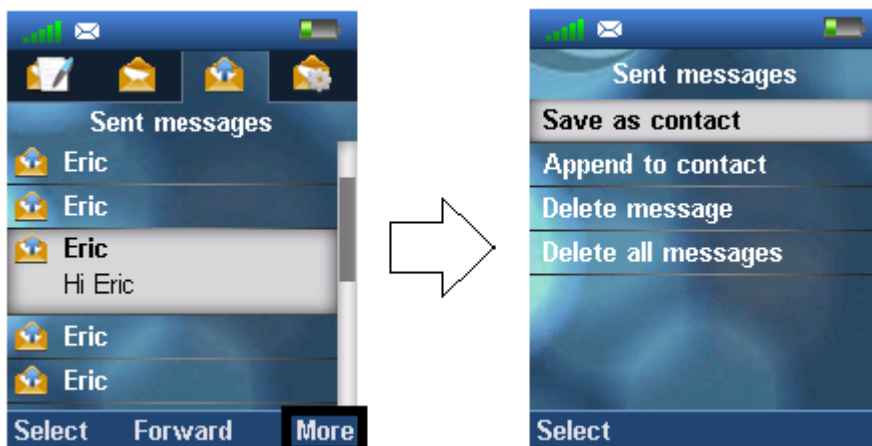

6.6.9 Settings

In the 'Settings' menu it is possible to set messaging options on or off. These options will be described below.

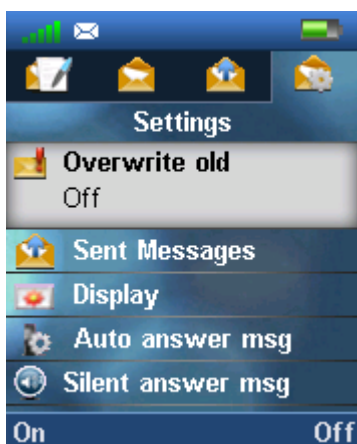

Overwrite old

If this option is set to 'On' with the left softkey, then the oldest messages is overwritten if the maximum number of messages is reached. The maximum number of messages that can be stored in drafts, inbox, and sent messages is 250. If the number of 250 messages is exceeded, and the option is set to 'Off' then no new messages can be received before deleting some old messages manually.

Sent Messages

If this function is set to 'On' then the sent messages will be saved, whereas the sent messages will not be saved if it is set to 'Off'.

Display

This function controls if the content of new messages are displayed in idle when they are received, or if it is just displayed that a new message has been received. Below, it is displayed how the two settings are displayed in idle when a new message is received.

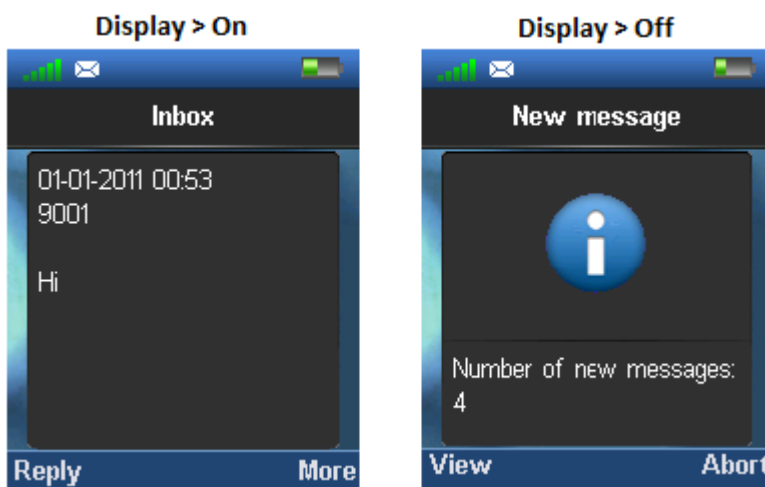

6.7 Alarms

The "Alarm" menu is entered through the menu by pressing the activity menu key  in idle.



This feature allows that alarms can be set on the handset to occur at a specific time.

Alarm

When "Alarm" is selected it is possible to set a time for an alarm to occur, and then press left softkey "Save" to save the alarm.

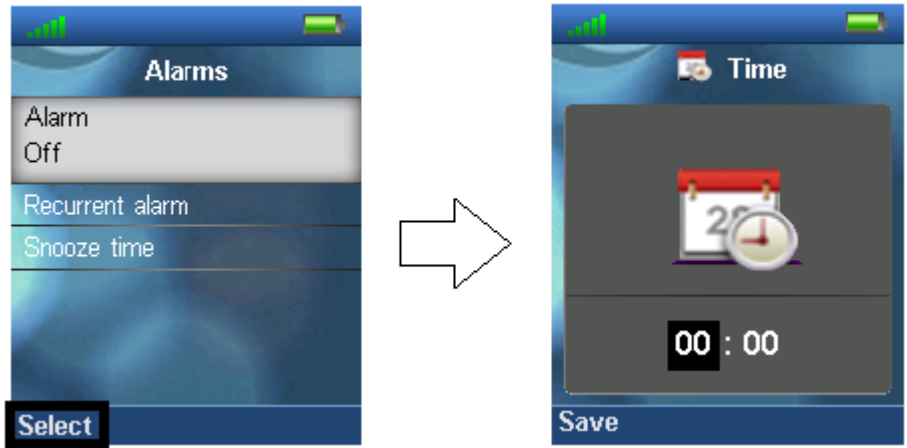

An alarm will then occur at the time that has been set. The time can both be set with the numeric keypad, or with the up/down navigation keys.

Recurrent alarm

This feature enables another alarm to be set, thereby another time can be saved by pressing left softkey "Save". In this way, two alarms can occur.

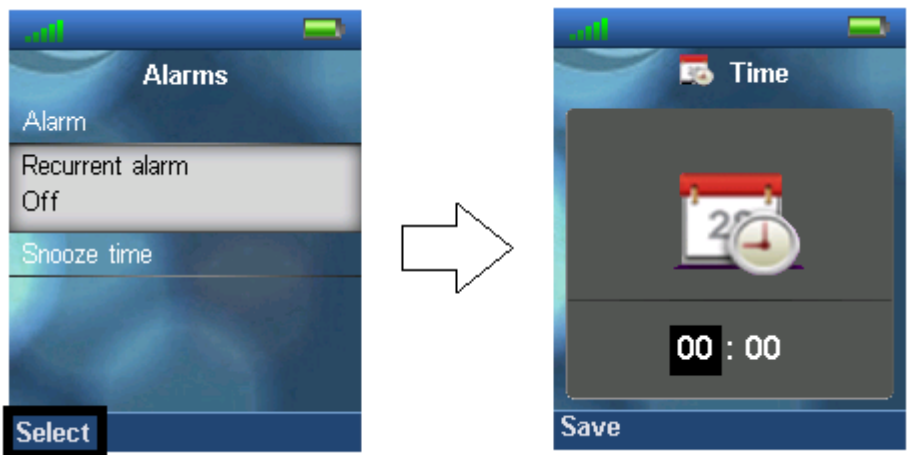

The time can both be set with the numeric keypad, or with the up/down navigation keys.

Snooze time

The "Snooze time" indicates the time for the alarm to be snoozed when it goes off.

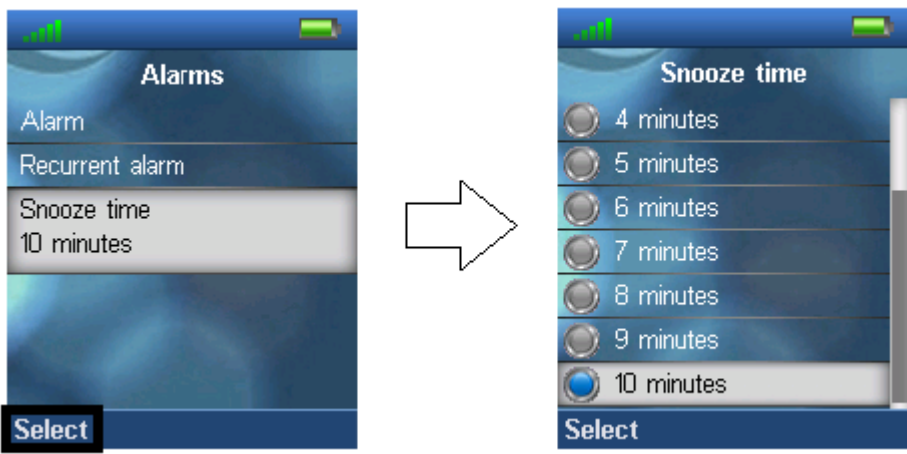

This means that when the alarm occurs the user can either “Dismiss” it with the right softkey, or “Snooze” it with the left softkey. In this case the snooze time gives the time before the alarm occurs again.

NOTE: If the handset is in silent mode or if the volume is set to mute then an alarm will be a silent alarm, and no sound will be heard during the alarm. The “Silent Alarm” icon  will be displayed in the status bar.

6.8 F-Keys

The “F-Keys” menu is entered through the menu by pressing the activity menu key  in idle. This menu controls functional keys to be set on the handset. This means that the handset user is able to add certain functional numbers in this menu; as for example the number to the user’s mailbox.

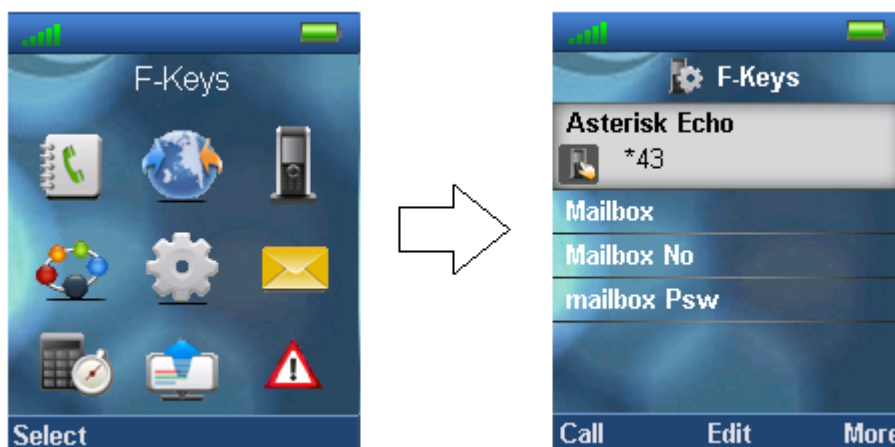

When there are F-Keys saved in the list it is possible to call each F-Key number by pressing the left softkey “Call”.

Additionally, each F-Key contact can be edited directly from the F-Key list by pressing the middle softkey “Edit”.

When pressing the right softkey “More” the following options are possible to select.

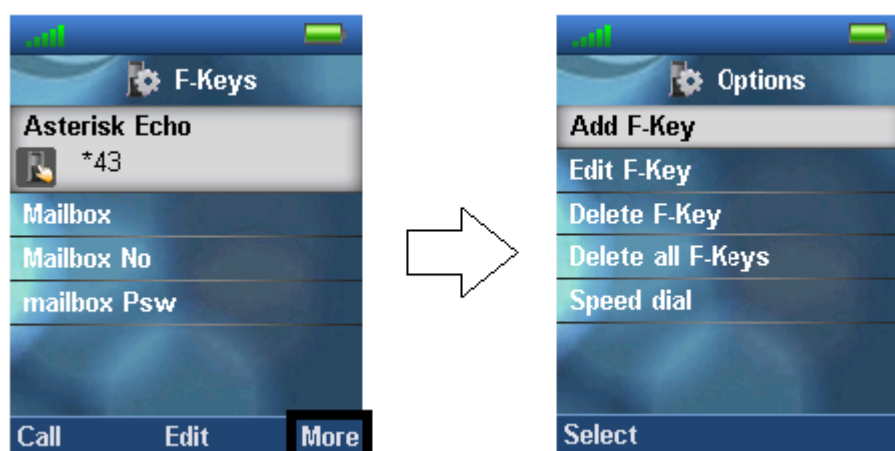

Add F-Key

To add a new F-key press the right softkey “More” and it is possible to add a new functional key. In the case of e.g. adding a user’s mailbox, pressing the right softkey “Edit” makes it possible to enter the

name and number, respectively. For the new F-key to be saved press the left softkey “Save”, and this F-key is added to F-keys.

Edit F-Key

This feature enables that an existing F-key can be edited, if the name or number need changing.

Delete F-Key

By selecting “Delete F-Key” the message “Delete current contact from F-Key list?” appears on the screen, and it is possible to press the left softkey “Yes” to delete the currently highlighted F-Key, or to press the right softkey “No” to cancel and go back to the F-Keys menu.

Delete all F-Keys

With this function it is possible to delete all the saved F-Keys on the handset. When selecting “Delete all F-Keys” the message “Delete entire F-Key list?” appears, and by pressing left softkey “Yes” this action is performed, whereas pressing the right softkey “No” cancels the action and returns to the F-Keys menu.

Speed dial

When selecting “Speed dial” the list with speed dial numbers assigned to long pressing the numbers 2-9 appears.

From this menu it is possible to add the chosen F-Key to a speed dial number with the left softkey “Add”. If an already existing speed dial entry is highlighted the left softkey gives the opportunity to instead “Replace” the current speed dial entry with this one.

To delete a speed dial entry press the right softkey “Delete” and the entry is deleted straightaway.

NOTE: This speed dial list uses both contacts from the contact list, and from the F-Keys list. For additional information on this feature see the section *7.1.4 Speed Dial/On Touch Dial*.

6.9 Alarm List

The handset can receive and send emergency alarms. These different emergency settings are defined and controlled from the web interface of the base station. But triggering an emergency alarm is done from the handset. For further explanation about the emergency settings see the base station manual via reference [3].

6.9.1 How to Trigger Alarms on the Handset

Five different alarm types can be triggered on the handset which is described in more detail in the following.

Emergency Button Alarm

This alarm is triggered by long-pressing (3 seconds) the red button on top of the handset.

Pull Cord Alarm

The Pull Cord alarm can be triggered by pulling a cord containing a magnet from the pull cord hole on the right side of the handset.

Running Alarm

To trigger the Running Alarm the handset needs to be shaken up and down for a couple of seconds. Hereby the running alarm is triggered by running if the user has the handset in the hand or in a pocket or similar during running.

Man Down Alarm

The Man Down alarm is triggered if the handset is lying down in an angle from 60degrees. The time for the handset to be still before the alarm is triggered can be set on base station web interface (in reference to next chapter 6.9.2)

No Movement Alarm

To trigger the No Movement alarm the handset needs to be in no movement. As with the man down alarm the time for this before the no movement alarm is triggered is set on the base station web interface emergency settings.

6.9.2 How to Control the Emergency Settings on the Base Station Web Interface

In the Emergency Settings menu on the web interface of the system base station it is controlled how an alarm appears on the handset. As for example if the handset detects “Man Down”, it is defined in this menu what alarm signal this type of alarm will send out and which priority the alarm has etc.

Emergency Settings

Alarm Block Time:

Idx	Profile Alias	Alarm Type	Alarm Signal	Alarm Priority	Stop Alarm from Handset	Trigger Delay	Stop Pre-Alarm from Handset	Pre-Alarm Delay	Howling
0	Alarm 1	Man Down ▼	Call ▼	1 ▼	Enabled ▼	<input type="text" value="0"/>	Enabled ▼	<input type="text" value="0"/>	Disabled ▼
1		Disabled ▼	Call ▼	0 ▼	Enabled ▼	<input type="text" value="0"/>	Enabled ▼	<input type="text" value="0"/>	Disabled ▼
2		Disabled ▼	Call ▼	0 ▼	Enabled ▼	<input type="text" value="0"/>	Enabled ▼	<input type="text" value="0"/>	Disabled ▼
3		Disabled ▼	Call ▼	0 ▼	Enabled ▼	<input type="text" value="0"/>	Enabled ▼	<input type="text" value="0"/>	Disabled ▼
4		Disabled ▼	Call ▼	0 ▼	Enabled ▼	<input type="text" value="0"/>	Enabled ▼	<input type="text" value="0"/>	Disabled ▼
5		Disabled ▼	Call ▼	0 ▼	Enabled ▼	<input type="text" value="0"/>	Enabled ▼	<input type="text" value="0"/>	Disabled ▼
6		Disabled ▼	Call ▼	0 ▼	Enabled ▼	<input type="text" value="0"/>	Enabled ▼	<input type="text" value="0"/>	Disabled ▼
7		Disabled ▼	Call ▼	0 ▼	Enabled ▼	<input type="text" value="0"/>	Enabled ▼	<input type="text" value="0"/>	Disabled ▼

All configuration of the handset Emergency Settings is done from the base station. The concept is that on the “Emergency Settings” page on the web server, eight different alarm profiles can be configured.

The parameters that can be configured are:

Parameters	Description
Alarm Block Time	This is the period from one alarm has fired until a new alarm is allowed. That is, if a new alarm fires before the Alarm Block Time has expired, the alarm will be ignored by the handset. The Alarm Block Time parameter is the same for all alarms, and hence it is not part of the profiles that can be configured.
Idx	Indicates the index number of a specific alarm.

Profile Alias	An alias or user-friendly name to help identify the different profiles when selecting which profiles to enable for the individual handsets.
Alarm Type	The type of alarm is dependent of what kind of event that has triggered the alarm on the handset. The handset supports either of the following categories: Man Down No Movement Running Pull Cord Emergency Button Disabled
Alarm Signal	The way the alarm is signaled as it is received on the handset. Message: The alarm is sent as a text message to an alarm server, and is accordingly received as an alarm message on the handset(s) receiving the alarm. Call: The alarm is made as an outgoing call to the specified emergency number for the extension.
Alarm Priority	The priority of the alarm. A higher priority alarm can interrupt a lower priority alarm (higher number = higher priority). 0-7: The Alarm Priority can be set from 0-7.
Stop Alarm from Handset	Enable/disable the possibility to stop/cancel the alarm from the handset.
Trigger Delay	The period from when the alarm has fired until the handset shows a pre-alarm warning. If set to 0, there will be no pre-alarm warning, and the alarm will be signalled immediately.
Stop Pre-Alarm from Handset	Enable/disable the possibility to stop/cancel the pre-alarm from the handset.
Pre-Alarm Delay	The period from the pre-alarm warning is shown until the actual alarm is signalled.
Howling	Enable/disable if howling shall be started in the handset, when the alarm is signalled. If disabled, only the configured signal is sent (call or message).

6.9.2.1 Alarms Sent as Messages

When the “Alarm Signal” is set to “Messages”, an alarm messaging server needs to be setup on the base station. This is done by entering the menu “Management”, enabling “Text Messaging Enabled”

and filling out “Text Messaging Server” and “Text Messaging Port” (see 6.6.1 How To Setup Text Messaging).

6.9.2.2 How to Configure Alarms on the Handset

Afterwards for each handset in the extension page, it can be selected which of the configured alarm profiles, the given handset shall subscribe to.

Extensions

[Add extension](#)
[Stop Registration](#)

Idx	IPEI	Handset State	FW Info	FWU Progress	VoIP Idx	Extension	Display Name	Server	Server Alias	State
<input type="checkbox"/>	0253EAB134	Removed@RPN00			<input type="checkbox"/>	1	2101	192.168.11.99	Asterix	
<input type="checkbox"/>	0253EAB0C5	Present@RPN00	320.3	Complete	<input type="checkbox"/>	2	2102	192.168.11.99	Asterix	SIP Registered@RPN00
<input type="checkbox"/>	0253EAB13D	Present@RPN00	320.3	Complete	<input type="checkbox"/>	3	2103	192.168.11.99	Asterix	SIP Registered@RPN00
<input type="checkbox"/>	0253EAB14D	Present@RPN00	320.3	Complete	<input type="checkbox"/>	4	2104	192.168.11.99	Asterix	SIP Registered@RPN00
<input type="checkbox"/>	0253EAB139	Present@RPN00	320.3	Complete	<input type="checkbox"/>	5	9000	192.168.11.99	Asterix	SIP Registered@RPN00

Check All / Uncheck All Check All Extensions / Uncheck All Extensions

With selected: [Delete Handset\(s\)](#) [Register Handset\(s\)](#) [Deregister Handset\(s\)](#) [Start SIP Registration\(s\)](#) [SIP Delete Extension\(s\)](#)

To configure an alarm profile for a certain handset click on the IPEI of that handset, and the following screen will appear allowing you to setup emergency settings for the handset.

Handset

Location:

IPEI:

AC:

Emergency Line:

Emergency Number:

Emergency Profiles:

Profile	Alarm Type	
Profile 0 (Man Down)	Man Down	<input type="checkbox"/>
Profile 1 (No Movement)	No Movement	<input type="checkbox"/>
Profile 2 (Running)	Running	<input checked="" type="checkbox"/>
Profile 3 (Pull Cord)	Pull Cord	<input checked="" type="checkbox"/>
Profile 4 (Emergency Button)	Emergency Button	<input checked="" type="checkbox"/>
Profile 5	Not configured	<input type="checkbox"/>
Profile 6	Not configured	<input type="checkbox"/>
Profile 7	Not configured	<input type="checkbox"/>

Before the emergency settings can be set on the handset an “Emergency Line” must be set, and an according “Emergency Number” to be called if one of the alarms are triggered.

To activate a certain alarm type on the handset, it must be ticked as seen above. For the handset shown above it means that Running, Pull Cord, and Emergency Button can be triggered from that handset whereas Man Down and No Movement are not ticked meaning that these alarms cannot be triggered on that handset.

NOTE: After saving these emergency settings for the extension the handset or the base station must be power cycled for the changes to take effect. When this is done the selected alarm profiles are sent to the handset.

6.9.1 The Alarm List Menu

The “Alarm List” menu is reached from the menu, and in this submenu the alarms that the handset has received are displayed. Below it is displayed if there are no alarms on the handset.



If any alarms has been received on the handset these is displayed in the “Alarms” menu. Additionally, each alarm is indicated with a specific color according to the specific priority of each alarm which is displayed below.

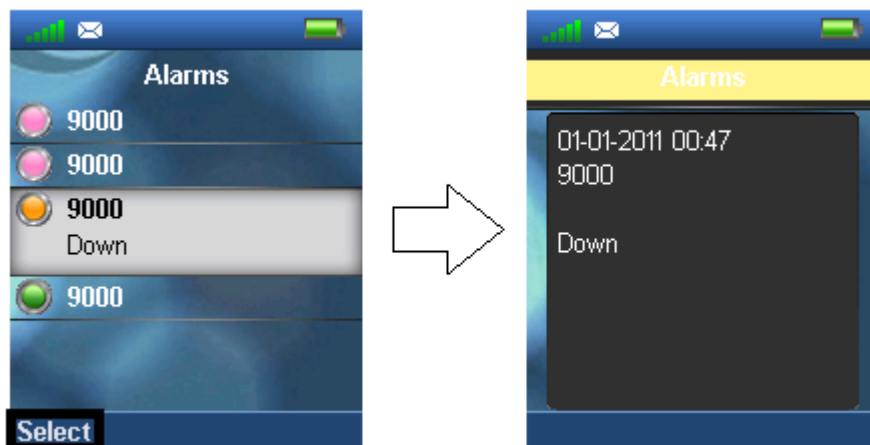

By selecting a specific alarm the details regarding it is displayed as seen above.

6.9.2 An Incoming Alarm

When the handset receives an alarm a specific alarm tone is played, and the alarm can be green, yellow, or red as displayed below. The alarm can be viewed by pressing the left softkey “Ok”, or it can be rejected by pressing the middle softkey “Reject” whereas it is not saved in the “Alarms” menu.

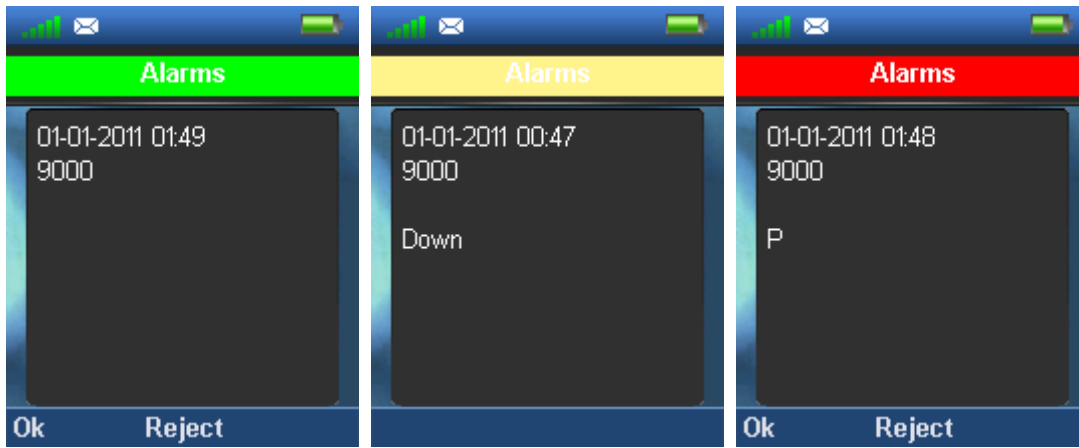

The color of the alarm represents what priority the alarm has. The priority of different scenarios to start the alarm is set on the server, and it is defined what should send a green, yellow, or red alarm to the handset. Additionally, an alarm can be sent out to either one handset, or more handsets which is also defined in the server settings.

7 Calls Operations

In this section the different types of calls and call handling will be described.

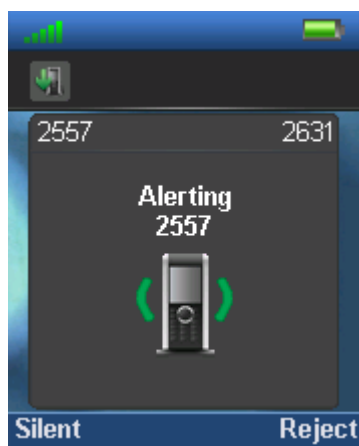

7.1 Incoming call

As the handset receives an incoming call an alerting screen will be displayed as displayed below. This will be accompanied by a ring signal and/or a vibrating handset according to the respective settings on the handset.



The calling party's handset number will be shown in the display, and an additional name is displayed if the calling party's handset number is stored in the local phonebook.

7.1.1 Answering an Incoming Call

To answer an incoming call press the green "Off-hook" button , or press the "Loudspeaker" key  to answer the call in speaker mode.

NOTE: When "Auto answer" is set to "Automatic" an incoming call is answered automatically after one ring signal. If "Auto answer" is set to "Any key" an incoming call can be answered by pressing any key on the keypad, and not just the green "Off-hook" button.

7.1.2 Reject an Incoming Call

It is possible to reject an incoming call by pressing the right softkey "Reject" when receiving an incoming call. This way the calling party will receive a busy tone, and "User busy" displayed on the screen as shown in the picture below.

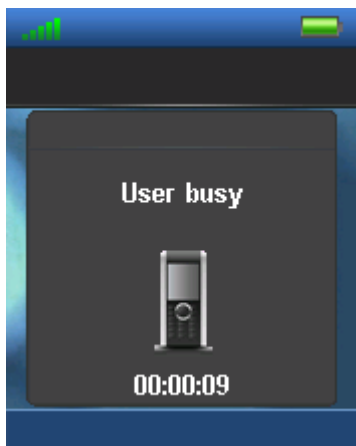

NOTE: An incoming call can also be rejected by pressing the red “On-hook” key.

7.1.3 Silencing an Incoming Call

When the handset is alerting it is possible to press the left softkey “Silent” whereas the handset will continue to alert, but without any heard ringing.

7.1.4 Ending a Call

To end an ongoing call press the red “On-hook” key , and the call will be terminated. The duration of the call is shown in the display. Furthermore this duration time can also be viewed from the call list where the call is stored.

NOTE: If one call is active and another call is on hold, then the active call will be terminated when pressing the red “On-hook” button, and the handset automatically returns to the call on hold; i.e. the call on hold is now active, and the user has to press the red “On-hook” button again to terminate this call.

7.2 Initiating a Call

A call can be initiated from different locations on the handset:

- By entering the number directly from idle
- From the “Contacts” menu
- From the “Calls” menu
- From the “Central Directory”

How to initiate a call from these different directories is explained in the following sub sections.

7.2.1 Initiating a Call from Idle

When initiating a call it must be done according to the following:

1. Enter the number of the person you want to call when the handset is in idle.
2. Press the green “Off-hook” button  to call the number.

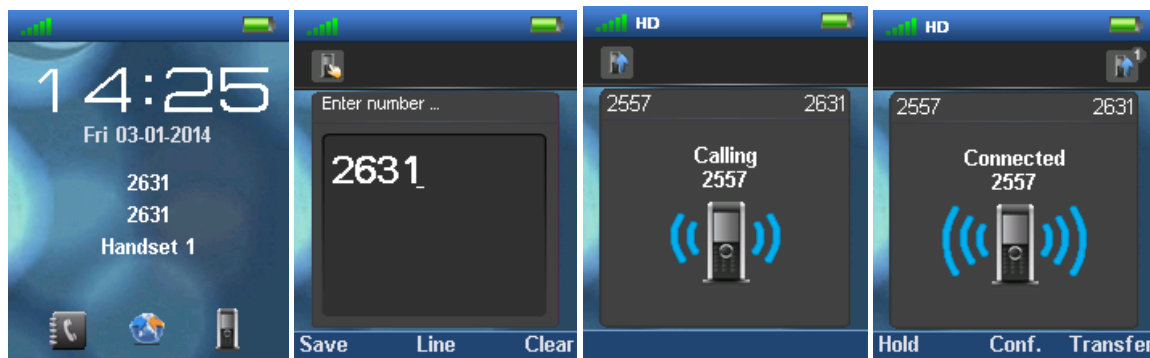

3. The handset will show a “Calling” screen as seen above.
4. When the counterpart answers the call the screen will show “Connected”, and the two parts are now in call.

7.2.1.1 Line Call

If the handset is used in a multiline environment, it is possible to make a call from different lines by pressing the middle softkey “Line”, and choose the line according to which system the call should be made from. See 7.5.6 *Handset Name, Line, Reset Settings, Status*.

NOTE: To see additional information on the “Line” function, please check the base system document via [3].

7.2.2 Initiating a Call from Contacts

To initiate a call from the contact list, there has to be contacts added to the local phonebook. When this prerequisite is met a local contact can be called by highlighting the contact in the contact list, and then pressing the left softkey “Call”, or pressing the green “Off-hook” button.

NOTE: The list of local contacts can be reached from the menu “Contacts” or directly from idle by pressing the left softkey when in idle.

7.2.3 Initiating a Call from Calls

The number of an outgoing, incoming or missed call can be called directly from the call list by highlighting the number and pressing the left softkey “Call” or the green “Off-hook” button to call the entry.

NOTE: The “Calls” list can be reached from the menu “Calls” or directly from idle by pressing either the green “Off-hook” button or the right softkey when in idle.

7.2.4 Initiating a Call from the Central Directory

When opening the “Central directory” a call can be made to a specific contact by searching for this contact, and thereby enter the list from which a contact can be called by pressing the green “Off-hook” key.

If different numbers are assigned to one contact a green arrow is showed to the right of the contact, and the right/left navigation keys can be used to choose which number that should be called.

NOTE: The “Central Directory” can be reached both from the menu “Central Directory” or directly from the idle by pressing the middle softkey when in idle.

7.3 Call Holding/Retrieving

It is possible to hold a call which means that the one party of the call is put on hold and cannot hear the other party, but can only hear a repeated short tone on hold until the call is retrieved.

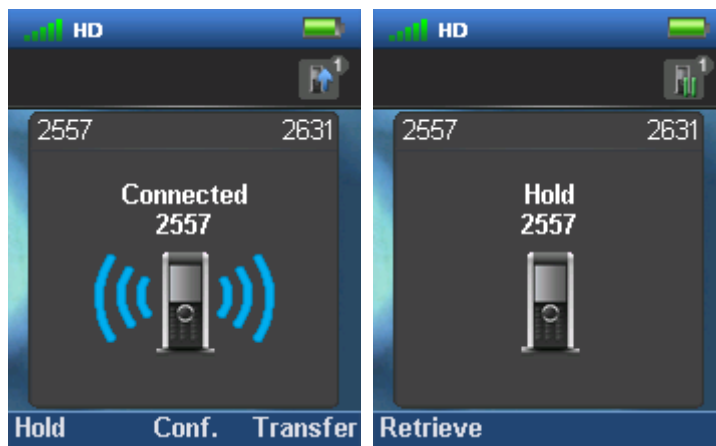

1. To put the counterpart of the call on hold press the left softkey “Hold”, and this party is put on hold.
2. To retrieve the call, and thereby continue the conversation, press left softkey “Retrieve” which is only showed on the screen when the other party of the call is put on hold.

NOTE 1: If one call is active and another call is on hold, then the active call will be terminated when pressing the red “On-hook” button, and the handsets automatically returns to the call on hold, i.e. the call on hold is now active, and the user has to press the red “On-hook” button again to terminate this call.

NOTE 2: When the counterpart is put on hold it is also possible establish a second call and make a conference, swap or transfer which will be explained in the following sections.

7.4 Attended and Unattended Transfer of a Call

When in an ongoing call, it is possible for either party to transfer the call, either attended or unattended, to another handset.

7.4.1 Attended Transfer

In an attended transfer the party that call is transferred to, is called before the transfer is made. The procedure to do this is as follows.

1. Initiate a call with a counterpart, so that the handset displays “Connected” as shown below.



2. Press the right softkey “Transfer” on either of the handsets in call, and the counterpart of the call is put on hold.
3. Enter the number that the transfer should be made to, and press the green “Off-hook” button

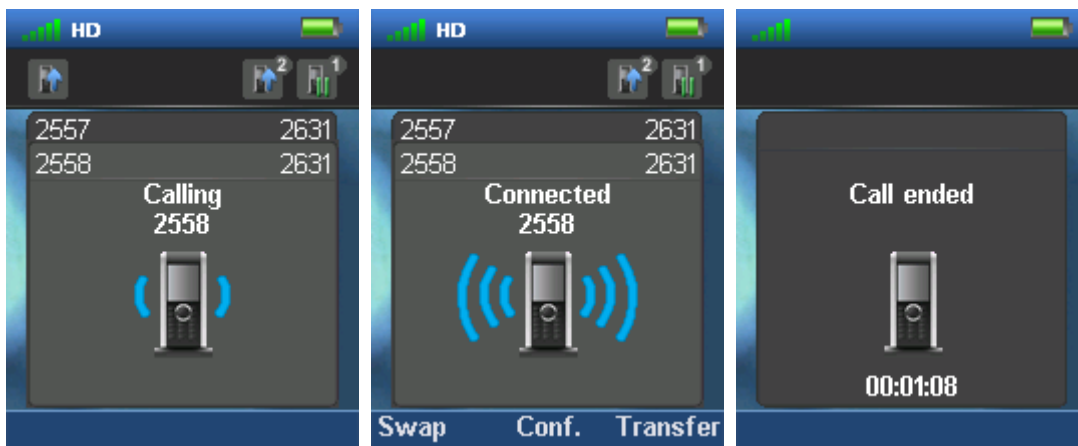

4. A ring back tone is heard and a third party is called.
5. As the third party answers the call the handset user initiating the transfer will show a connected screen as seen above.
 - **NOTE:** The original calling parties and the third party to whom the transfer has been made are displayed at the top of the active screen. Here, it is seen that it is the handset with number 2631 that is trying to make an attended transfer to the third party with number 2558.
6. To make the transfer after the third party has answered the call, press the right softkey “Transfer”, and the call is transferred so that the second and third party are now in call, and a “Call ended” screen is displayed on the handset that initiated the transfer as seen above.

NOTE: It is also possible to make an attended transfer by pressing either the left softkey “Hold”, or the middle softkey “Conf.” instead of pressing the right softkey “Transfer” in step 2.

7.4.2 Unattended Transfer

When making an unattended transfer, the call will be transferred directly to a third party without the party initiating the transfer needing to call this third party before the transfer.

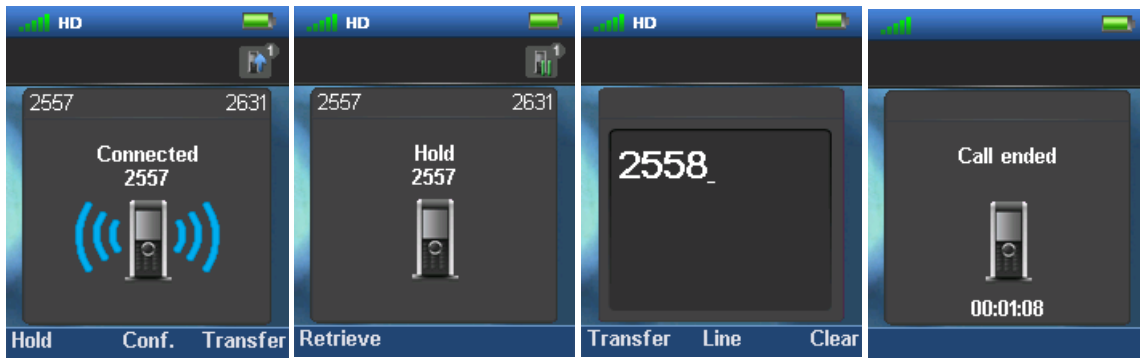

1. Initiate a call with a counterpart so that the handset displays “Connected” as shown above.
2. Press the right softkey “Transfer” on either of the handsets in call, and the counterpart of the call is put on hold.
3. Enter the number that the transfer should be made to, and press transfer.
4. This will end the call on the first handset party (screen showing “Call ended”), and the second party will stop being on hold and hear a ringback tone instead which indicates that this handset is now calling the third party.
5. When the third party answers the call an unattended transfer has been made and the second and third party are now in call.

NOTE: As with attended transfer, it is also possible to make an unattended transfer by pressing either the left softkey “Hold”, or the middle softkey “Conf.” instead of pressing the right softkey “Transfer” in step 2.

7.5 Swap between Two Calls

It is possible to swap between two calls. In this case, one party will be in ongoing call, and the second party will be on hold. I.e. “Swap” means that it is possible to toggle between these two parties.



1. Initiate a call with a counterpart so that the handset displays “Connected” as shown above.
2. Put this call on hold by pressing the left softkey “Hold”.
3. Enter the number of a second party, and press the green “Off-hook” button.
4. A ring back tone is now heard in the handset as the second party is alerting.



5. As the second party answers the call a blue “Connected” screen as above is displayed.
6. By pressing the left softkey “Swap” the green “Connected” screen is displayed instead which indicates that the ongoing call is now between the first party whereas the second party is now put on hold.
7. From this point, it is possible to toggle between the two parties by pressing “Swap”. For each time that “Swap” is pressed a toggle is made between the two external parties, and the “Connected” screen shows either blue or green signal lines to indicate if it is the first or second call that is ongoing.

7.6 Call Waiting

When two parties are in call it is possible to receive a call waiting on one of the handsets which means that a third party calls one of the two parties already in call. During a call waiting two short beeps are heard every three seconds in the handset receiving the call waiting, and the following screen is displayed:

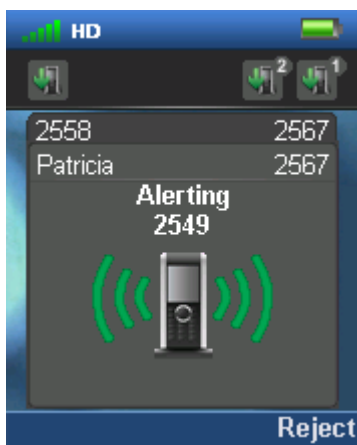

In this case it is seen that the ongoing call is with party 2558 whereas the call waiting is from party 2549 (that is called Patricia in the local phonebook).

It is possible to reject the call waiting with the right softkey “Reject”, and hereby continuing the ongoing call with party 2558.

If the call party wants to answer the call waiting the green off-hook key should be pressed, and the following screen is displayed:

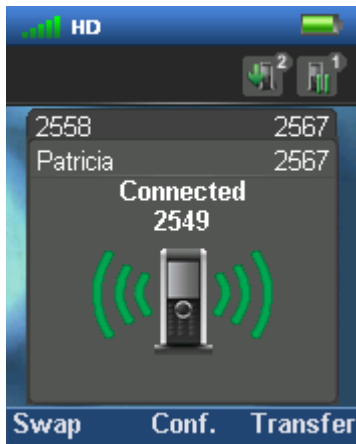

This indicates that the party 2567 now has two ongoing calls with one of them on hold, and it is possible to swap between them, make a conference, or transfer one of the parties.

7.7 Conference Call

In a conference call there are always at least three parties in the same conversation. Hereby, this feature enables the user to have an ongoing call with more than one person – the parties in a conference call are called participants.

7.7.1 Establishing a Conference Call

In the following, it is described how to establish a conference call between three parties.



1. Initiate a call with a counterpart so that the handset displays “Connected” as shown above.
2. Press the middle softkey “Conf.” to start a conference call.
3. The second party is put on hold and will hear a tone on hold.
4. Enter the number of the party to invite to the conference and press the green “Off-hook”

button  to call this participant.

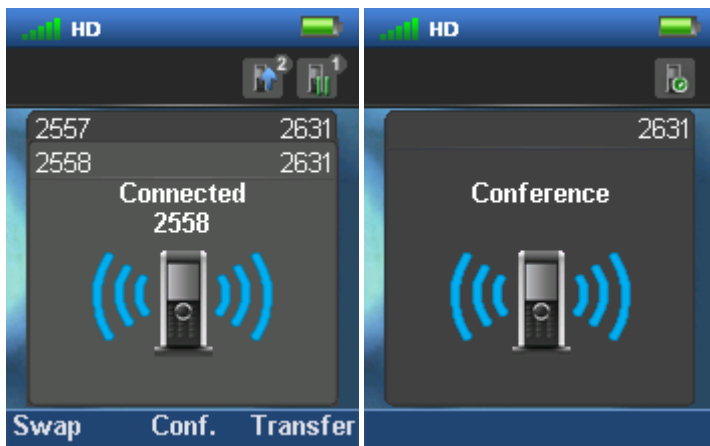

5. When the called party answers the call the second party is still on hold, and the conversation is only between the third party and the first party, i.e. initiator of the conference.
6. To start conversation between the three parties – i.e. a conference – press the middle softkey “Conf.”
7. The “Conference” screen as seen above will then be displayed, and the three participants will be in a conference call. Thereby the conversation is between all three parties.

NOTE 1: It is possible to invite more participants to the conference by repeating the steps 2. – 6. for one of the participants in the conference that has not yet invited a party to the conference. Once a participant has invited a new party to the conference it is not possible for this participant to invite new parties to the conference.

NOTE 2: The maximal amount of participants to participate in a conference call is set according to the number of bases in a system. On a system with two bases it should be possible to have 10 participants in a conference call.

7.7.2 Terminating a Conference Call

When a conference call is terminated it is dependent of which participant that terminates it, if the whole conference is terminated, or if the conference is ongoing between the two participants left in the conference.

Option 1

1. The user who has started the conference presses the red “On-hook” key  to terminate the conference call.
2. The whole conference is terminated, and none of the participants continue to be in call.

Option 2

1. One of the participants that have been invited to the conference presses the red “On-hook” key  to terminate the conference call.
2. The call is only terminated for the participant that terminated the call
3. There is still an ongoing call between the initiator of conference, and the participant that have not ended the call.

NOTE: Different configurations on the PBX that the base system uses may result in different terminations of a conference call. E.g. the configuration of some PBX's could cause that the whole conference call is not terminated if the initiator of the conference presses the red "On-hook" key to terminate.

8 SD Card

A SD card is an external memory card that gives the possibility of storing information from the handset externally. In this way more people can use the same handset since the SD card is the memory unit containing all individual data. The SD card can then be inserted into one handset making that your personal handset on one day, and inserted into another handset which makes that your personal handset on another day.

8.1 How to Insert the SD Card in the Handset

The RTX8830 handset supports a micro SD card which is inserted right under the battery as illustrated below:

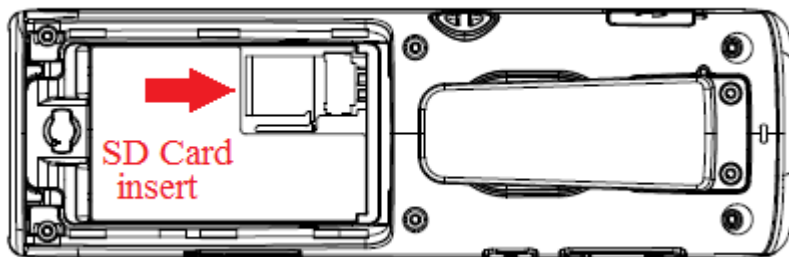

When a SD card is inserted in the handset an “NVS Configuration” screen is displayed showing that the handset is loading information from the SD card.

Hereby the handset starts up using the SD card as its memory. In other words, re-registration of the handset, storing of local contacts, messages or received alarms will all be stored on the SD card when the handset is using this as memory.

8.2 Inserting a SD Card With or Without Information

The handset handles it differently if it is an empty SD card that is inserted, or if the SD card already does contain information.

8.2.1 Inserting an Empty SD Card

If a handset is configured, registered to a base station, and containing other information (as local contacts, messages, alarms etc.) and an empty SD card is inserted into the handset, then all the information from the handset will be moved to the SD card.

In this way the SD card will remove the registration from the handset and move it to the SD card instead. All the other information as settings, local contacts, call lists, messages, alarms, F-keys, and alarms is copied to the SD card as well, but this information will also be retained on the handset.

Hereby the SD card is a total copy of the handset and contains all of its information. It is described below what inserting such an SD card containing information into another handset will do.

8.2.2 Inserting an SD Card Containing Information

When an SD card with information is inserted in a handset, the handset will use this information instead of the information already on the handset. This means that despite the handset already having

a certain registration on a base station, inserting the SD card will make the handset use the registration from the SD card instead of its own.

In this way, the information of the SD Card will always be used instead of the information of the handset when an SD card is inserted in the handset.

NOTE: The SD card will never overwrite the information already on the handset, but the user will just get the information from the SD card instead of the handset when an SD card is in the handset. If the SD card is removed from the handset again, the original information on the handset is used.

8.3 SD Card White List

The following types of SD cards are on the white list for the RTX8830 Handset:

- Transcend: 4GB, 8GB, 16GB, and 32GB
- Kingston: 4GB, 8GB, 16GB, and 32GB

9 Accessories

It is possible to get different accessories to the RTX SME VoIP 8830 handset. These different accessories are listed in the following:

- Dual Charger
- Single Charger
- Adapter for Charger
- Vertical Leather Pouch
- Horizontal Leather Pouch
- Belt Clip
- Swivel Belt Clip
- Battery
- Battery Cover
- Headset Deployment tool 3.5mm
- RTX2610 HS Plug version 3.5mm

10 Troubleshooting

This troubleshooting section contains information on how to solve some operational problems that you may experience on the handset.

10.1 Operational problems

State: *The handset does not ring*

Problem cause: The sound off icon is seen in the status bar; hence the handset is silent mode.

Action: Increase the volume in Audio Settings, or long press the #-key in idle.

NOTE: If the Audio Settings is greyed out and cannot be changed, it is because the silent mode is enabled by long pressing the #-key. Please, long press the #-key in idle to disable this silent mode.

State: *The handset does not respond when pressing on the keys*

Problem cause: The keylock is enabled, and a “Press and hold *” screen is displayed when pressing any key.

Action: Long press (press for more than 2 seconds) the *-key.

State: *The handset shows “Searching” in the display*

Problem cause: The handset is out of the coverage area of the base station system.

Action: Please move the handset back in coverage of the base system.