



User Guide for the Polycom[®] SoundPoint IP[®] 560 Phone

SIP 3.1

August, 2008 Edition
1725-12567-001 Rev. C
SIP 3.1



Trademark Information

Polycom®, the Polycom logo design, SoundPoint® IP, SoundStation®, SoundStation VTX 1000®, ViaVideo®, ViewStation®, and Vortex® are registered trademarks of Polycom, Inc. Conference Composer™, Global Management System™, ImageShare™, Instructor RPT™, iPower™, MGC™, PathNavigator™, People+Content™, PowerCam™, Pro-Motion™, QSX™, ReadManager™, Siren™, StereoSurround™, V²IU™, Visual Concert™, VS4000™, VSX™, and the industrial design of SoundStation are trademarks of Polycom, Inc. in the United States and various other countries. All other trademarks are the property of their respective owners.

Patent Information

The accompanying product is protected by one or more U.S. and foreign patents and/or pending patent applications held by Polycom, Inc.

Disclaimer

Some countries, states, or provinces do not allow the exclusion or limitation of implied warranties or the limitation of incidental or consequential damages for certain products supplied to consumers, or the limitation of liability for personal injury, so the above limitations and exclusions may be limited in their application to you. When the implied warranties are not allowed to be excluded in their entirety, they will be limited to the duration of the applicable written warranty. This warranty gives you specific legal rights which may vary depending on local law.

Copyright Notice

Portions of the software contained in this product are:

Copyright © 1998, 1999, 2000 Thai Open Source Software Center Ltd. and Clark Cooper

Copyright © 1998 by the Massachusetts Institute of Technology

Copyright © 1998-2003 The OpenSSL Project

Copyright © 1995-1998 Eric Young (eay@cryptsoft.com). All rights reserved

Copyright © 1995-2002 Jean-Loup Gailly and Mark Adler

Copyright © 1996 - 2004, Daniel Stenberg, <daniel@haxx.se>

Permission is hereby granted, free of charge, to any person obtaining a copy of this software and associated documentation files (the "Software"), to deal in the Software without restriction, including without limitation the rights to use, copy, modify, merge, publish, distribute, sublicense, and/or sell copies of the Software, and to permit persons to whom the Software is furnished to do so, subject to the following conditions:

The above copyright notice and this permission notice shall be included in all copies or substantial portions of the Software.

THE SOFTWARE IS PROVIDED "AS IS", WITHOUT WARRANTY OF ANY KIND, EXPRESS OR IMPLIED, INCLUDING BUT NOT LIMITED TO THE WARRANTIES OF MERCHANTABILITY, FITNESS FOR A PARTICULAR PURPOSE AND NONINFRINGEMENT. IN NO EVENT SHALL THE AUTHORS OR COPYRIGHT HOLDERS BE LIABLE FOR ANY CLAIM, DAMAGES OR OTHER LIABILITY, WHETHER IN AN ACTION OF CONTRACT, TORT OR OTHERWISE, ARISING FROM, OUT OF OR IN CONNECTION WITH THE SOFTWARE OR THE USE OR OTHER DEALINGS IN THE SOFTWARE.

© 2008 Polycom, Inc. All rights reserved.

Polycom Inc.
4750 Willow Road
Pleasanton, CA 94588-2708
USA

No part of this document may be reproduced or transmitted in any form or by any means, electronic or mechanical, for any purpose, without the express written permission of Polycom, Inc. Under the law, reproducing includes translating into another language or format.

As between the parties, Polycom, Inc. retains title to, and ownership of, all proprietary rights with respect to the software contained within its products. The software is protected by United States copyright laws and international treaty provision. Therefore, you must treat the software like any other copyrighted material (e.g. a book or sound recording).

Every effort has been made to ensure that the information in this manual is accurate. Polycom, Inc. is not responsible for printing or clerical errors. Information in this document is subject to change without notice.

About This Guide

Thank you for choosing the for the SoundPoint IP 560 , a full-duplex, hands-free SIP desktop phone. This unit provides business telephony features and functions such as multiple call appearances, call hold, transfer, and conference over an IP network.

This guide provides everything you need to quickly use your new phone. Be sure to verify with your system administrator that your network is prepared for configuring your for the SoundPoint IP 560 phone. As well, be sure to read the [Parts List](#) and [Regulatory Notices](#) sections in this guide before you set up and use the for the SoundPoint IP 560 phone. You can also find this information at <http://www.polycom.com/support/voip/>.

Changes to This Guide

The following section is new for this edition:

- [Registering Your SoundPoint® IP 560 Desktop Phone](#) on page 1-8

Major updates have occurred to the following sections since the previous edition:

- [Selecting the Correct Headset for Electronic Hookswitch](#) on page 2-6
- [Assigning Speed Dial Keys](#) on page 3-22
- [Restarting Your Phone](#) on page 4-8

Contents

About This Guide	iii
Changes to This Guide	-iii
1 Getting Started with Your SoundPoint® IP 560 Desktop Phone	1-1
Parts List	1-2
Assembling Your SoundPoint® IP 560 Desktop Phone	1-3
Connecting the Handset and Optional Headset	1-5
Attaching the Base	1-5
Registering Your SoundPoint® IP 560 Desktop Phone	1-8
Features of Your SoundPoint® IP 560 Desktop Phone	1-8
Before You Use Your SoundPoint® IP 560 Desktop Phone	1-13
Using the Navigation Keys	1-13
2 Customizing Your SoundPoint® IP 560 Desktop Phone	2-1
Configuring Basic Settings	2-2
Changing the Appearance of Time and Date	2-2
Changing the Display Contrast	2-3
Changing the Backlight Intensity	2-4
Enabling the Headset Memory Mode	2-6
Selecting the Correct Headset for Electronic Hookswitch	2-7
Selecting the Ring Type	2-7
Changing the Language	2-8
Changing the Graphic Display Background	2-9
Muting the Microphone	2-10
Adjusting the Volume	2-10
Managing Call Lists	2-10
Managing Contacts	2-11
Adding Contacts	2-12
Editing Contacts	2-15
Deleting Contacts	2-16

Placing Calls to Contacts	2-16
Searching for Contacts	2-17
Managing Incoming Calls	2-19
Distinguishing Calls	2-19
Rejecting Calls	2-20
Diverting Calls	2-20
System Customizations	2-21
Supporting Multiple Lines	2-21
Supporting Multiple Line Keys Per Line	2-22
Supporting Shared Lines	2-23

3 Using the Basic Features of Your SoundPoint® IP 560 Desktop Phone3-1

Placing Calls	3-2
Answering Calls	3-4
Ending Calls	3-7
Redialing Numbers	3-8
Placing Calls on Hold	3-8
Hosting Conference Calls	3-9
Setting Up Conference Calls	3-10
Managing Conference Calls	3-12
Adding Parties to Conference Calls	3-14
Joining Conferences	3-15
Splitting Conference Calls	3-16
Ending Conference Calls	3-16
Transferring Calls	3-16
Forwarding Calls	3-18
Enabling Do Not Disturb	3-21
Assigning Speed Dial Keys	3-22
Using Voice Mail	3-24

4 Using the Advanced Features of Your SoundPoint® IP 560 Desktop Phone4-1

Using Multiple Call Appearances	4-1
Using Text Messaging	4-3
Using Buddy Lists	4-5
Presence Settings	4-5
Managing Buddies	4-6
Integrating With Microsoft Live Communications Server 2005	4-7

Restarting Your Phone 4-8

5 Troubleshooting Your SoundPoint® IP 560 Desktop Phone . 5-1

Power and Startup 5-2
 Controls 5-3
 Access to Screens and Systems 5-4
 Calling 5-5
 Displays 5-7
 Audio 5-8
 Testing Phone Hardware 5-8

Regulatory NoticesRegulatory Notices-1

IndexIndex-1

Getting Started with Your SoundPoint® IP 560 Desktop Phone

This chapter provides basic installation instructions and information for obtaining the best performance with the SoundPoint IP 560 desktop phone.

The SoundPoint IP 560 provides a powerful, yet flexible IP communications solution, delivering excellent voice quality. The high-resolution graphic display supplies content for call information, multiple languages, directory access, and system status. The SoundPoint IP 560 supports advanced functionality, including multiple call and flexible line appearances, HTTPS secure provisioning, presence, custom ring tones, local conferencing, applications, and Polycom® HD™ Voice technology.

Powered by state of the art Gigabit Ethernet IP telephony technology, the SoundPoint IP 560 features a future-proof dual-port Gigabit Ethernet switch for seamless integration with a computer or desktop server. For organizations with existing GigE deployment, the SoundPoint IP 560 delivers unobstructed, high-speed access to data and productivity-boosting data and applications. For organizations with plans to migrate to GigE, the SoundPoint IP 560 protects investment in desktop networking.

This chapter contains:

- [Parts List](#)
- [Assembling Your SoundPoint® IP 560 Desktop Phone](#)
- [Registering Your SoundPoint® IP 560 Desktop Phone](#)
- [Features of Your SoundPoint® IP 560 Desktop Phone](#)
- [Before You Use Your SoundPoint® IP 560 Desktop Phone](#)

To customize your phone, refer to [Customizing Your SoundPoint® IP 560 Desktop Phone](#) on page 1-1. To read about the phone's basic features, refer to [Using the Basic Features of Your SoundPoint® IP 560 Desktop Phone](#) on page 3-1. To read the phone's advanced features, refer to [Using the Advanced Features of Your SoundPoint® IP 560 Desktop Phone](#) on page 4-1.

If you require additional information or assistance with your new phone, contact your system administrator.

Parts List

The following components are included in your SoundPoint IP 560 package:

- Polycom SoundPoint IP 560 phone

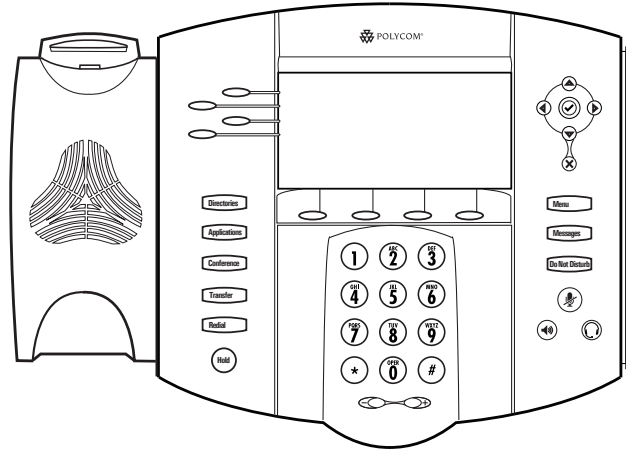

- handset and handset cord

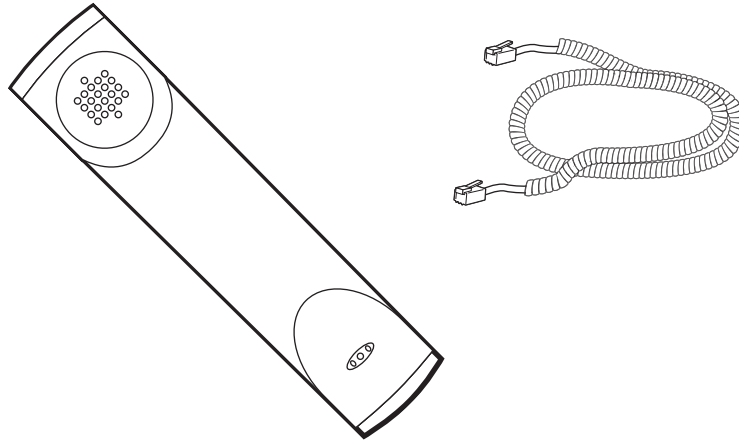

- Phone Base

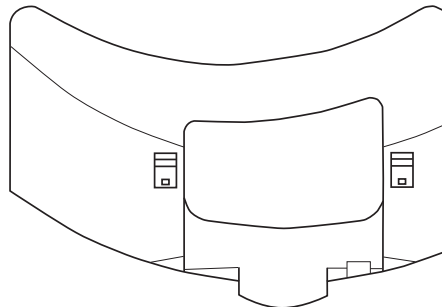

- Network / Power Cable

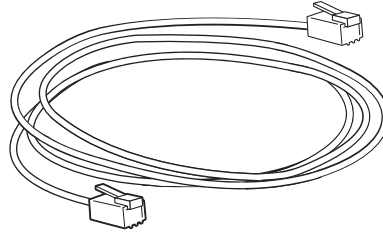

- Quick Start Guide and registration card

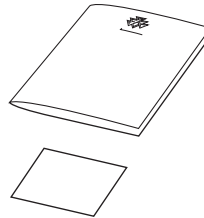

Check this list before installation to ensure that you have received each item. If you are missing any items, contact your system administrator.

Assembling Your SoundPoint® IP 560 Desktop Phone

This section describes how to assemble your SoundPoint IP 560 phone:

- Connect network and power source
- Connect handset and headset (optional)
- Attach phone base

If your phone is already assembled, go directly to [Features of Your SoundPoint® IP 560 Desktop Phone](#) on page 1-8.

You have two options for network and power source connections. Your system administrator will advise you on which one to use.

You can use one of the following methods:

- AC power
- Power over Ethernet (PoE)

AC Power

To connect the AC power:

1. Connect the supplied network cable between the LAN jack on the phone and the LAN port on the wall or hub/switch device.
2. Connect the DC plug on the power adapter to the DC 48V jack marked on the phone.
3. Connect the country-specific AC cord to the power adapter.

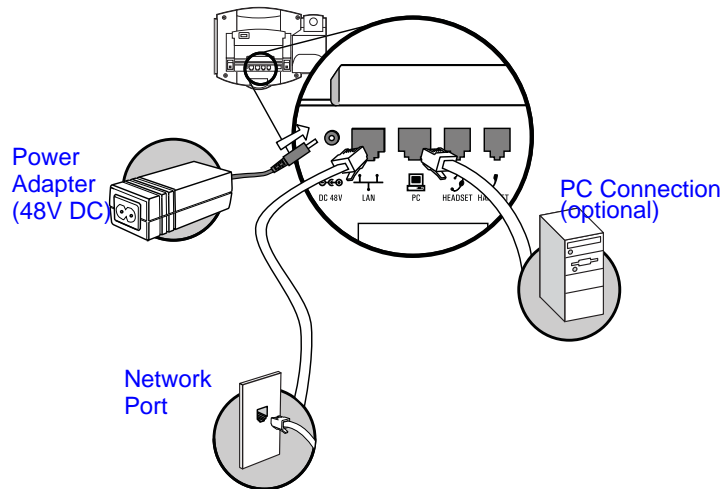

Power over Ethernet

Using a regular CAT5 cable (optional accessory from Polycom), the phone can be powered from a PoE (IEEE 802.3af) compliant switch or hub.

To connect the PoE:

- Plug the supplied network cable between the LAN jack on the phone and an available power and data port on the in-line power switch.

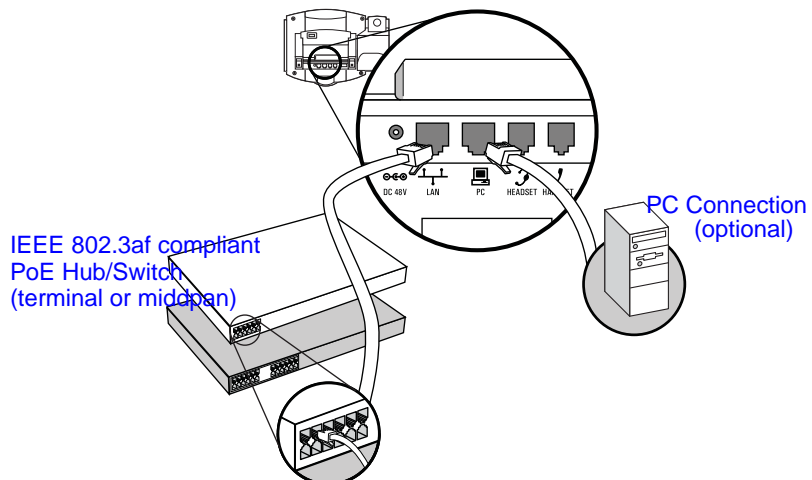

Connecting the Handset and Optional Headset

To connect the handset and optional headset:

1. Connect the short straight end of the phone cord to the handset and the corresponding longer straight end of the cord to the handset jack on the back of the phone.
2. Connect the headset (optional) to the headset jack on the back of the phone.

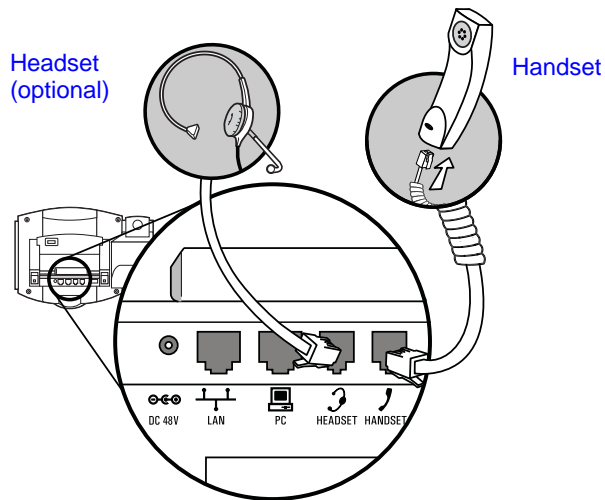

For information on supported headsets, go to www.polycom.com/support/voice and enter "Headset Compatibility List" in the Knowledge Base text box.

Attaching the Base

The phone base can be attached to the SoundPoint IP 560 in one of two ways:

- As a desk mount
- As a wall mount

To attach the base as a desk mount:

1. Place all cords in the recessed area above the modular jacks.

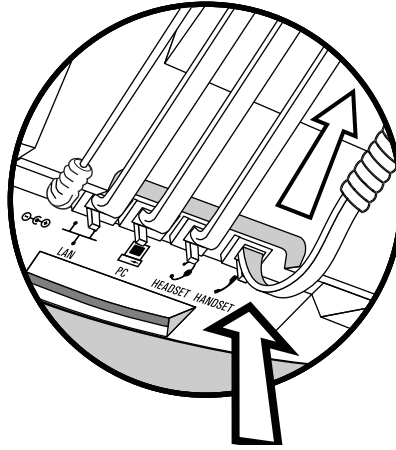

2. Align the two protrusions on the bracket with their corresponding holes in the phone.

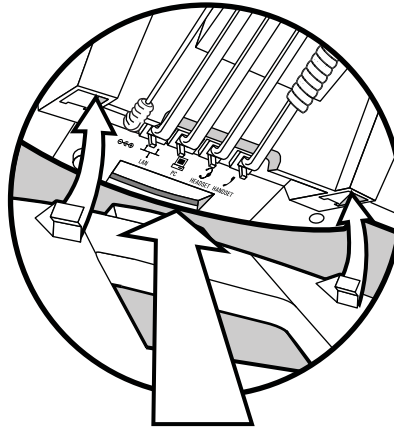

3. Snap them together to lock the base to the phone.

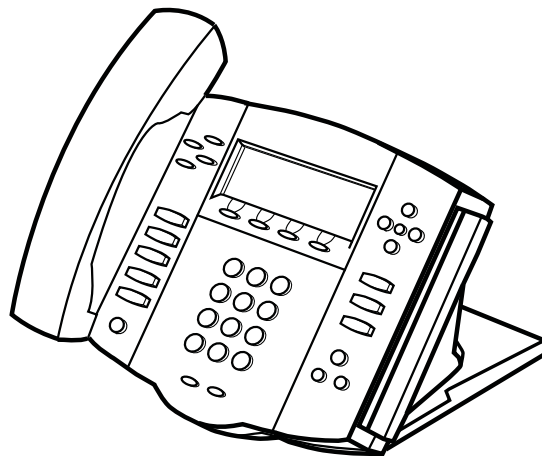

To attach the base as a wall mount:

1. Place all cords in the recessed area above the modular jacks.

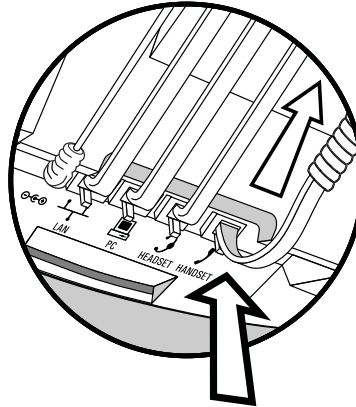

2. On the back of the phone, remove the key located behind the hookswitch and reposition it so that the end tab (at a 45° angle) is facing up.

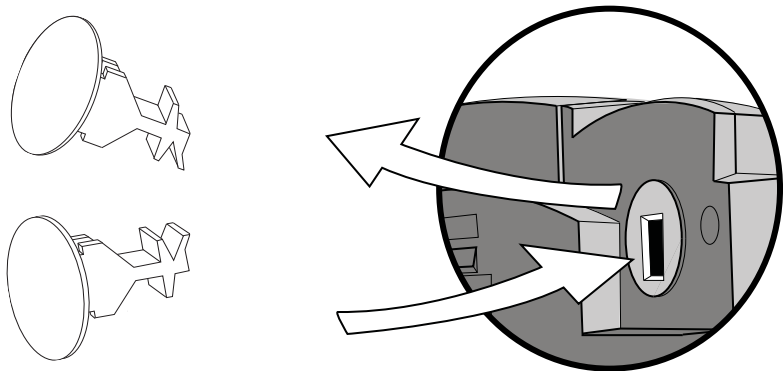

3. With mounting tab of the base unit facing up, fasten the base unit to the wall mount using wall anchors (not included).

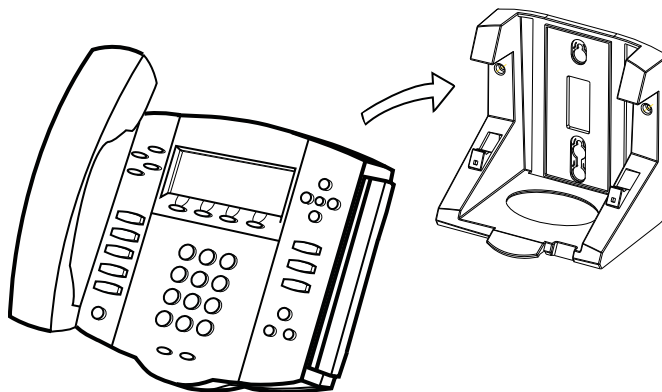

Note

The wall mount is not included in SoundPoint IP 560 package. Contact your system administrator if you require one.

Registering Your SoundPoint® IP 560 Desktop Phone







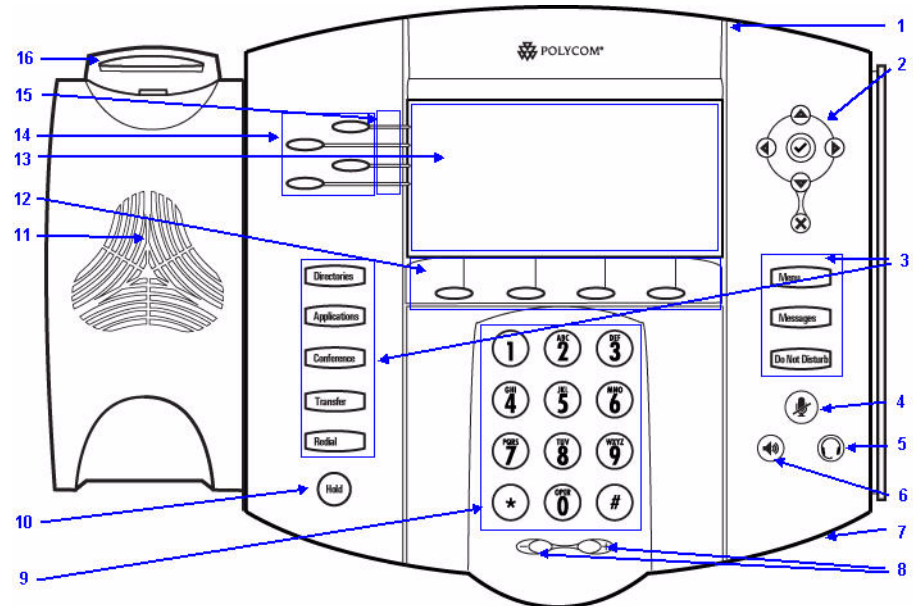









Generally, your phone will be deployed with multiple other phones. In this case, your system administrator will configure the phone parameters beforehand, so that after you set up your phone, the phone will be registered and ready to use.



If your phone is not part of a large phone deployment, your phone may not be registered after you set it up. Before you use your phone, you or your system administrator will have to register it. For detailed information on how to register your phone after you install it, refer to “Quick Tip 44011: Registering Standalone SoundPoint IP and SoundStation IP Phones” at http://www.polycom.com/usa/en/support/voice/soundpoint_ip/VoIP_Technical_Bulletins_pub.html.

Features of Your SoundPoint® IP 560 Desktop Phone













The features of your SoundPoint IP 560 phone are:

	Item	Description
1	Message Waiting Indicator	Alert for voice and text (instant) messages.
2	Arrow Keys	
	 	Scroll through displayed information.
	 	
		Select a field of displayed data.
		Delete displayed data.
3	Feature Keys	Access important features using these keys.
		Access to local directories and call lists.
		Access to special applications (contact system administrator).
		Allows connection with multiple other parties for a conference.
		Transfer of current call to third party.
		Dials most recently dialed party.
		Access local (your phone) and global (your organization) features.
		Access and manage text and voice messages.
		Cancels ringing and directs incoming calls to your voice mail (if supported).
4	Microphone Mute 	Mutes audio transmission locally during calls and conferences.
5	Headset 	Allows you to place and receive calls through an optionally connected headset.

	Item	Description
6	Speakerphone 	Allows for hands-free communication during calls.
7	Hands-free Microphone	Picks up audio during hands-free calls. Place your phone on a hard, flat surface for best results.
8	Volume Keys 	Adjusts the volume of the handset, headset, speaker, and ringer.
9	Dial Pad	Provides the 10 digits, the alphabetic characters, and special characters available in context-sensitive applications.
10	Hold 	Holds an active call or resumes a held call.
11	Speaker	For ringer and hands-free audio output.
12	Soft Keys	These keys are automatically labeled to identify their context-sensitive functions.
13	Graphic Display	Shows information about calls, messages, soft keys, time, date, and other relevant data. <ul style="list-style-type: none"> • Caller display information—first party, second party, number of calls • Information display line (in order of precedence highest to lowest) <ul style="list-style-type: none"> • Popup text (for example, network errors) • Do Not Disturb text • Missed call text or second incoming caller display • Prompt text (for example, “Enter number”) • Time and date text (if idle display is not used for time/date display) <p>Associated line icons are described in the following table.</p>

	Item	Description
14	Line/Speed Dial Key 	Use these keys to activate up to four lines or speed dials that can be assigned to your phone.
15	Line Indicators	Individual multi-color LEDs display the dynamic call state and remote user status (busy lamp field (BLF) and presence). The mapping is: <ul style="list-style-type: none">• Solid green—An active call is in progress.• Fast flashing green—There is an incoming (ringing) call.• Flashing green—The call is held by the other party.• Flashing red—The call is on hold.• Solid red—The line is busy remotely (shared lines)
16	Hookswitch	

Icons associated with the line keys appear on the graphic display and represent:

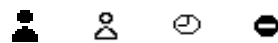
Icon	Description
	Registered line (solid)
	Registered shared line
	Unregistered line (outline)
	Voice mail/Text messages
	Speed dial
	Ringing
	Call in progress with HD Voice
	Call in progress
	Call Forward
	Do Not Disturb
	Conference
	Presence/Busy Lamp Field (BLF)









Before You Use Your SoundPoint® IP 560 Desktop Phone

Note

The background and key colors that appear on your SoundPoint IP 560 phone may differ from the screenshots that appear in this user guide.

Using the Navigation Keys

To help you navigate menus and enter data, use these tips:

- To scroll through lists, use  and  or hold down  and .
- Press the * key to page up. Press the # key to page down. Use these shortcuts when lists appear on more than one page.
- To move one level down and one level up when menus have submenus, use  and .
- To exit from any menu, press .
- To exit from any directory, press .
- Use the dial pad keys to navigate through and make selections in numbered menu lists.
- To enter text using the dial pad, press the number keys one or more times. For example, for 'A' press 2 and for 'C' press 222. When in text entry mode, the title will show whether keys will generate digits (1), upper-case (A), or lower-case (a) characters – use the **1/A/a** soft key to change – and whether keys will generate ASCII, Latin, Cyrillic, Katakana, or Unicode characters – use the **Encoding** soft key to change.

Customizing Your SoundPoint® IP 560 Desktop Phone

You can customize your SoundPoint IP 560 desktop phone by adjusting the setting for time and date, display contrast, and ring type, for example. You can add contacts to the phone's directory manually or from call lists. You can handle incoming calls from different contacts in different ways.

This chapter provides basic operating instructions for customizing your SoundPoint IP 560 phone. This chapter contains:

- [Configuring Basic Settings](#)
- [Managing Call Lists](#)
- [Managing Contacts](#)
- [Managing Incoming Calls](#)

Some customizations of your SoundPoint IP 560 phone are performed by your system administrator. These include:

- [Supporting Multiple Lines](#)
- [Supporting Multiple Line Keys Per Line](#)
- [Supporting Shared Lines](#)

To read about the phone's basic features, refer to [Using the Basic Features of Your SoundPoint® IP 560 Desktop Phone](#) on page 3-1. To read about the phone's advanced features, refer to [Using the Advanced Features of Your SoundPoint® IP 560 Desktop Phone](#) on page 4-1.

If you require additional information or assistance with your new phone, contact your system administrator.

Configuring Basic Settings

You can configure the following basic settings through use of  :

- Appearance of the time and date
- Display contrast
- Backlight intensity
- Headset Memory Mode
- Headset hookswitch selection
- Ring type
- Language support (localization)
- Background pattern

You can mute the microphone and adjust the volume using separate keys.

Changing the Appearance of Time and Date

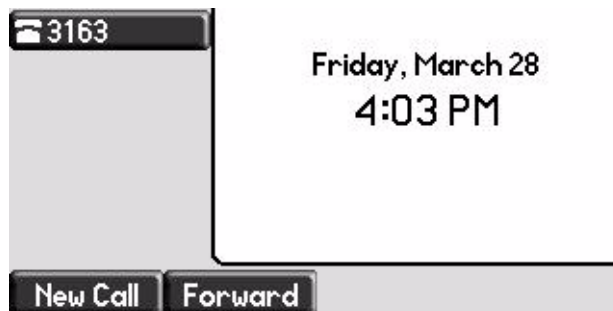

The time and date appears on the graphic display of the SoundPoint IP 560 phone. If the phone cannot obtain a time and date from the call server, the display will flash. Contact your system administrator if either the time or date is incorrect.

You can select from various formats for the time and date display. Select and set options that are right for you. You can also disable the time and date display, so the time and date do not display on the phone screen.





To configure the time and date formats:

1. Press .
2. Select **Settings > Basic > Preferences > Time & Date**.
3. Select from **Clock Date, Clock Time, Clock Order, or Enable/Disable**.

4. Using  and , scroll through the options under each of these selections.
5. Press the **Select** soft key to confirm your choice.

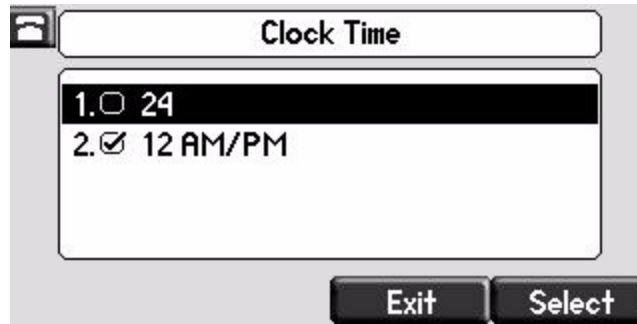
The following figure shows the Clock Time menu.



6. Press  to return to the idle display.

Changing the Display Contrast

To adjust the contrast on the display to a comfortable level:

1. Press .
2. Select **Settings > Basic > Contrast**.

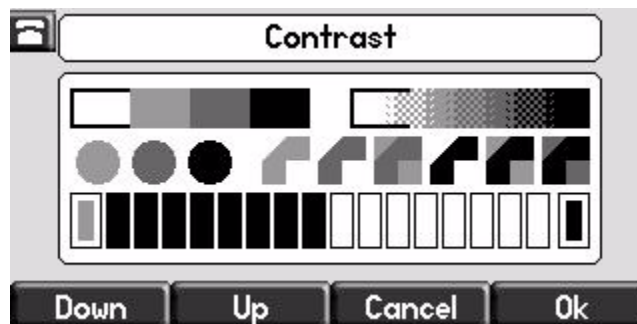

3. Press the **Up** or **Down** soft keys to increase or decrease the display contrast.

Note

You can also use the volume keys to increase or decrease the display contrast.

4. Press the **Ok** or **Cancel** soft keys to accept or cancel changes.
5. Press  to return to the idle display.

Changing the Backlight Intensity

Backlight intensity on the SoundPoint IP 560 phone has three components:

- Backlight On
- Backlight Idle
- Maximum Intensity

You can modify the Backlight On intensity and the Backlight Idle intensity separately. You can select high, medium, low, and off levels for both.

When you modify the Maximum Intensity, you are modifying the entire backlight intensity scale. For example, if you decrease the Maximum Intensity, the low, medium, and high values for both Backlight On intensity and the Backlight Idle intensity decrease.

The Backlight On intensity applies for the following events:

- Any key press
- Hookswitch release
- Incoming calls
- Ending a call, holding a call, resuming a call by the other party
- A voice or instant message received

If you do not press any keys on the phone after 20 seconds of the backlight turning on, the backlight dims (or changes) to medium in the following cases:

- A call is in progress
- A call is on hold
- There is an incoming call (ringing)
- There is an outgoing call (ringing back)
- Any menu shows on the display

In all other cases, the Backlight Idle intensity applies.

To modify the backlight intensity:

1. Press  .
2. Select **Settings > Basic > Backlight Intensity**.

3. Select **Backlight On Intensity**.



4. Use \triangle or ∇ to select high, medium, low, or off, and then press the **Select** soft key.

The default level is medium.

5. Select **Backlight Idle Intensity**.



6. Use \triangle or ∇ to select high, medium, low, or off, and then press the **Select** soft key.

The default level is low.

7. Select **Maximum Intensity**.

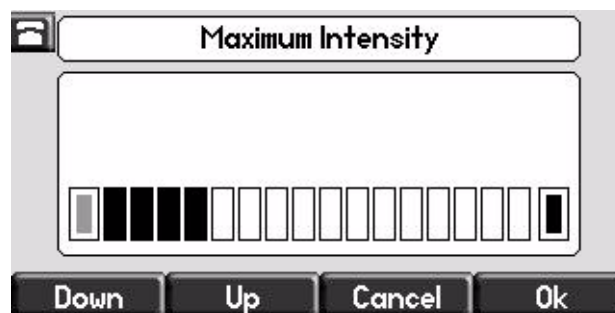

8. Press the **Up** or **Down** soft keys to increase or decrease the backlight intensity.



9. Press the **Ok** or **Cancel** soft keys to accept or cancel changes.

10. Press  to return to the idle display.

Enabling the Headset Memory Mode

This feature is especially useful for permanent or full-time headset users.

To permanently enable the Headset Memory Mode:

1. Press .
2. Select **Settings > Basic > Preferences > Headset... > Headset Memory...**
3. Use  or  to select Enabled, and then press the **Select** soft key.

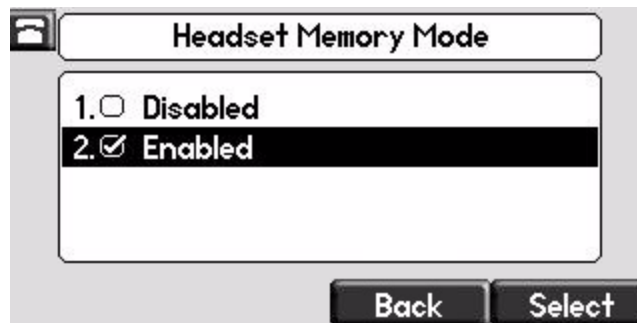

4. Press  to return to the idle display.

Repeat steps 1 to 4 to select Disabled and turn Headset Memory Mode off.

To activate Headset Memory Mode:

- >> Press  twice.

The flashing headset icon on the graphic display or a flashing headset key indicates that the headset mode is activated. Pressing  or the **Answer** soft key to receive a call will now connect to your headset automatically.



Selecting the Correct Headset for Electronic Hookswitch

This feature allows you to answer your phone when you are using a headset.



For information on supported headsets to provide electronic hookswitch features for placing, answering, and ending calls, go to www.polycom.com/support/voice and enter "Headset Compatibility List" in the Knowledge Base text box or contact your system administrator.

To select a headset that supports electronic hookswitch:

1. Press .
2. Select **Settings > Basic > Preferences > Headset > Analog Headset Mode**.
3. Use  or  to select your headset, and then press the **Select** soft key.

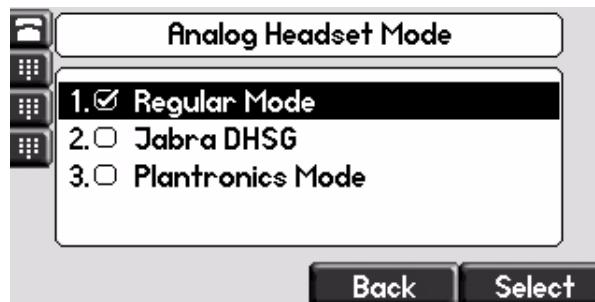





4. Press  to return to the idle display.

Selecting the Ring Type

You can select different ring types to distinguish lines or to distinguish your phone from your neighbor's phone.

To change the incoming ring type:

1. Press .
2. Select **Settings > Basic > Ring Type**.
3. (Optional.) If multiple lines are configured on your phone, first select the line to change from the list using the  and .

4. Use  and  to select the desired ring type.

To hear the selected ring type, press the **Play** soft key.



5. Press the **Select** soft key to change to the selected ring type.
6. Press  to return to the idle display.



Note

If you configure your SoundPoint IP 560 phone with a silent ring, press the flashing Line key or the **Answer** soft key to answer the call. If your handset is off hook, the call is routed to the handset. If your handset is on hook, the call is routed to the speaker.

Changing the Language

Many languages are supported by the SoundPoint IP 560 phone.

To change the language:

1. Press .
2. Select **Settings > Basic > Preferences > Language**.
3. Use  and  to highlight the language you want.



4. Press the **Select** soft key.

Text that appears on the graphic display will change to the language of your choice.



5. Press  to return to the idle display.

Changing the Graphic Display Background

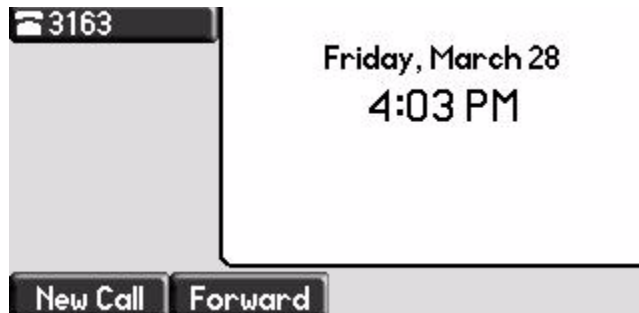
You can change the picture or design design that appears on the graphic display. A default background displays when the phone starts up (shown below). For more information on selections, contact your system administrator.



To change the graphic display background:

1. Press .
2. Select **Settings > Basic > Preferences > Backgrounds**.
3. Use  and  to highlight the background you want.



4. Press the **Select** soft key.
5. Press  to return to the idle display.

Muting the Microphone

During a call, press . The Message Waiting Indicator turns red and a microphone on the screen indicates that the other party (or parties) cannot hear you.

Microphone Mute applies to all modes: Handset, Headset, and Hands-free Speakerphone. You can still hear all other parties while mute is enabled.

To turn off Microphone Mute, press  again.

Adjusting the Volume

Press  to adjust receiver volume during a call. Pressing these keys in the idle state adjusts the ringer volume.

Note

To conform to regulatory requirements, handset and headset volume will return to a preset level after each call, but your system administrator can change this. Hands-free Speakerphone volume settings will be maintained across calls.

Managing Call Lists

Your phone maintains local lists of missed, received, and placed calls. Each list contains 100 entries.

Press  followed by **Call Lists > Missed Calls, Received Calls, or Placed Calls**. The following shows a Placed Calls list.



Manage the call list by doing the following:

- To edit the phone number, press the **Edit** soft key.
- To return the call, press the **Dial** soft key.
- To view information about the call, press the **More** soft key followed by the **Info** soft key.

- To store the contact in the Contact Directory, press the **More** soft key followed by the **Save** soft key.
- To delete the call from the list, press the **More** soft key followed by the **Clear** soft key.

Press  to return to the idle display.

Note

Press the **Right** arrow key from the idle display to access the Placed Calls list. Press the **Left** arrow key from the idle display to access the Received Calls list. Press the **Down** arrow from the idle display to access the Missed Calls list. You can use these shortcuts while placing calls or performing transferring and conferencing functions.

Note

You can manually clear all call lists. They are automatically cleared when you restart the phone.

Managing Contacts

You can store a large number of contacts in your phone's directory. Contact your system administrator for the exact number.

You can add, edit, delete, dial, or search for a contact in this directory. You can dial or search for a contact in this directory. You may be able to add, edit, and delete contacts.



You may have read access to portions of your corporate directory through your phone. The contacts that you can see are determined by your system administrator. You can add contacts from the corporate directory to your local contact directory.

Adding Contacts

You can add contacts to your contact directory:

- Manually
- From a call list
- From your corporate directory

Adding Contacts Manually

To add a contact to the local contact directory manually:

1. Press .
2. Select **Contact Directory**.
3. Press the **More** soft key.
4. Press the **Add** soft key.
5. Enter first and/or last name of the contact from the keypad.

Use the **1/A/a** soft key to select between numeric and upper/lower case alphanumeric modes.

Use the **Encoding** soft key to access special characters in other languages.



6. Enter a contact number.
This is a required field and it must be unique (not already in the directory).

7. (Optional.) Change the Speed Dial Index.

It is automatically assigned to the next available index value.

Valid speed dial index values are from 1 to 9999. If you enter a speed dial index that already, "Speed dial index already exists" appears. If you enter an invalid value, "Speed dial index invalid" appears.

For more information, refer to [Assigning Speed Dial Keys](#) on page 3-22.



8. (Optional.) Change the Ring Type and Divert Contact.

These fields may be left blank.

For more information on setting the Ring Type field, refer to [Distinguishing Calls](#) on page 2-19.

For more information on diverting contacts, refer to [Diverting Calls](#) on page 2-21.

9. (Optional.) Change the Auto Reject, Auto Divert, Watch Buddy, and Block Buddy.

Use  and  to switch between Enabled and Disabled settings.

For more information on setting the Auto Reject field, refer to [Rejecting Calls](#) on page 2-20. For more information on setting the Watch Buddy and Block Buddy fields, refer to [Managing Buddies](#) on page 4-6.

10. Press the **Save** or **Cancel** soft keys to accept or cancel changes.

11. Press  to return to the idle display.





Adding Contacts From Call Lists

To add a contact to the local contact directory from a call list:

1. Do one of the following:

- a Press  .

Select **Call Lists >Missed Calls, Received Calls, or Placed Calls** as desired.

- b** Press , , or  to access the desired call list.
- 2.** Use  and  to highlight the contact.
You can also use the * key to Page Up and the # key to Page Down.
- 3.** Press the **More** soft key, and then the **Save** soft key to save the contact in the phone's directory.



- 4.** Press  to return to the idle display.

Note

You may want to go to the local contact directory to check if the contact was saved correctly, and to add any missing fields.

Adding Contacts From the Corporate Directory

To add a contact to your local contact directory from the corporate directory:

- 1.** Press .
- 2.** Select **Corporate Directory**.
- 3.** Search for the contact.

Refer to [Searching for Contacts](#) on page 2-17.

4. Press the **View** soft key.

The contact's information appears on the graphic display.





5. Press the **Save** soft key to save the contact in the local contact directory. "Entry saved" appears on the graphic display. Only the first name, last name, and phone number are saved.

If the contact already exists in the contact directory, "Entry already exists" appears.

6. Press  to return to the idle display.

Editing Contacts

To edit a contact in the local contact directory:

1. Press .
2. Select **Contact Directory**.
3. Use  and  to highlight the contact.
You can also use the * key to page up and the # key to page down.
4. Press the **Edit** soft key
5. Edit the contact information.







6. Press the **Save** or **Cancel** soft keys to accept or cancel changes.
7. Press  to return to the idle display.

Note

You can quickly edit a contact associated with a speed dial key by pressing and holding the contact's speed dial key, and then complete steps 5 to 7.



Deleting Contacts

To delete a contact from the local contact directory:

1. Press  .
2. Select **Contact Directory**.
3. Use  and  to highlight the contact.
You can also use the * key to page up and the # key to page down.
4. Press the **More** soft key twice, and then press the **Delete** soft key.
The contact is deleted from the directory.
5. Press  to return to the idle display.

Placing Calls to Contacts

To place a call to a contact in the local contact directory:

1. Press  .
2. Select **Contact Directory**.
3. Use  and  to highlight the contact.
You can also use the * key to page up and the # key to page down.
4. Press the **Dial** soft key.

To place a call to a contact in the corporate directory:

1. Press  .
2. Select **Corporate Directory**.

3. Search for the contact.

Refer to [Searching for Contacts](#) in the corporate directory on page 2-17.

4. Press the **View** soft key.

The contact's information appears on the graphic display.



5. Press the **Dial** soft key.

Searching for Contacts

To search for a contact in the local contact directory:

1. Press **Directories**.
2. Select **Contact Directory**.
3. Press the **More** soft key, and then the **Search** soft key.
4. Using the dial pad, enter the first few characters of the contacts's first or last name.



5. Press the **Search** soft key again.



You can dial any successful matches from the resulting information on the graphic display.

To search for a contact in the corporate directory:

1. Press .
2. Select **Corporate Directory**.

Note

When you first access the corporate directory, the message “Directory update in progress” appears momentarily. Then the corporate directory entries appear. If no corporate directory entries appear, review your search criteria. Your criteria may be set to exclude all corporate directory entries.

3. Search for the contact in one of the following ways:
 - Use  and  to highlight the contact.
You can also use the * key to Page Up and the # key to Page Down.
 - Press the **Search** soft key, and then enter the first few letters or numbers of the first name, last name, or any other parameter displayed in the list. Press the **Submit** soft key.



- Using the dial pad, enter the first few characters of the contacts’ last name.

The characters that you enter appear on the second line of the graphic display.



You can dial any successful matches from the resulting information on the graphic display.

Managing Incoming Calls

You can distinguish incoming calls by setting distinctive rings for contacts in your contact directory, sending particular calls directly to your voice mail, or transferring particular calls to another party.

Distinguishing Calls

You can customize your phone so that you can distinguish different parties by ring type.

Note

This feature is local to the phone, and may be overridden by your organization's settings. For more information, contact your system administrator.

To set a distinctive ring type for a contact:

1. Press **Directories**.
2. Select **Contact Directory**.
3. Use **▲** and **▼** to highlight the contact.
You can also use the * key to page up and the # key to page down.
4. Press the **Edit** soft key, and then scroll down to the Ring Type field.



5. Enter the number corresponding to one of the ring types available.
For more information, refer to [Selecting the Correct Headset for Electronic Hookswitch](#) on page 2-7.
6. (Optional.) To remove an existing value, press **⊗**.
7. Press the **Save** or **Cancel** soft keys to accept or cancel changes.
8. Press **Directories** to return to the idle display.

Rejecting Calls

You can customize your phone so that incoming calls from a particular party are immediately sent to your voice mail.

Note

Rejecting calls is not available on shared lines.

To send incoming calls from a contact directly to voice mail:

1. Press **Directories**.
2. Select **Contact Directory**.
3. Use **▲** and **▼** to highlight the contact.
You can also use the * key to page up and the # key to page down.
4. Press the **Edit** soft key, and then scroll down to the Auto Reject field.





5. Use the **◀** and **▶** to select Enabled.
6. Press the **Save** or **Cancel** soft keys to accept or cancel changes.
7. Press **Directories** to return to the idle display.

Diverting Calls



You can customize your phone so that incoming calls from a particular contact are transferred directly to a third party.

To divert incoming calls from a particular contact:

1. Press **Directories**.
2. Select **Contact Directory**.

3. Use  and  to highlight the contact.
You can also use the * key to page up and the # key to page down.
4. Press the **Edit** soft key, and then scroll down to the Divert Contact field.



5. Enter the number of the party to whom you want to divert the call.
6. Scroll down to the Auto Divert field.
7. Use the  and  to select Enabled.
8. Press the **Save** or **Cancel** soft keys to accept or cancel changes.
9. Press  to return to the idle display.

System Customizations

The following section details customizations of your SoundPoint IP 560 phone that are performed by your system administrator.

Supporting Multiple Lines

Your SoundPoint IP 560 phone can support up to 8 lines.

Typically, the top-most Line Key is reserved for the principal directory number (DN) of the phone.

Depending on how your administrator sets up your phone, the display could resemble one of the following figures:

- One line, 3163

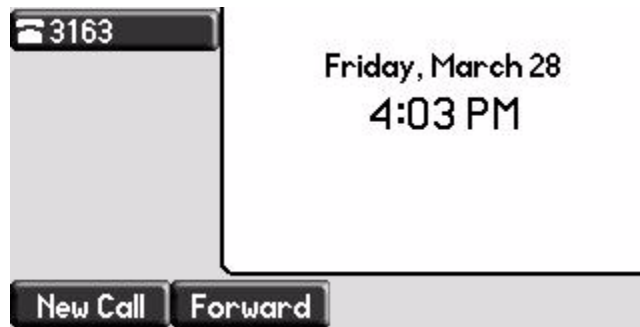

- Two lines, 3161 and 3163

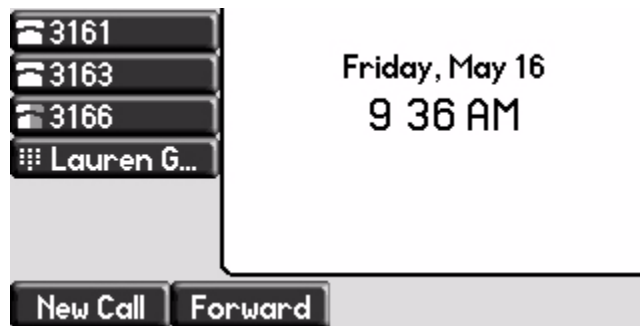

Supporting Multiple Line Keys Per Line

Each line on the phone can be configured to have more than one Line Key associated with it. This enhances call visualization and simplifies call handling. If this is the case, the display could resemble the following figure:

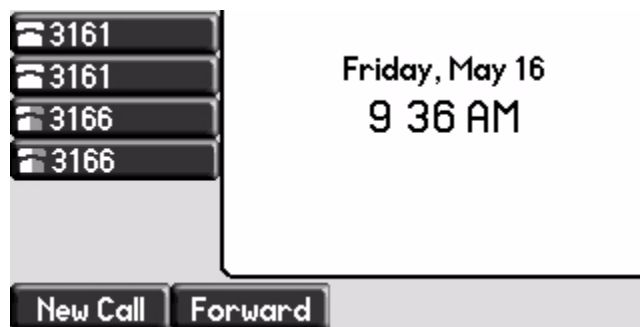

Incoming calls to this line will be distributed evenly among the available Line Keys. Similarly, outgoing calls will be distributed.

Your phone can be configured to have a combination of lines with a single Line Key and lines with multiple Line Keys.

Supporting Shared Lines

Your SoundPoint IP 560 supports shared lines.

Note

Shared lines are an optional feature and may not be supported on your particular system. For more information, contact your system administrator.

A shared line is indicated by a different line icon. In the following figure, the lines 3161 and 3163 are private and the line 3166 is shared.

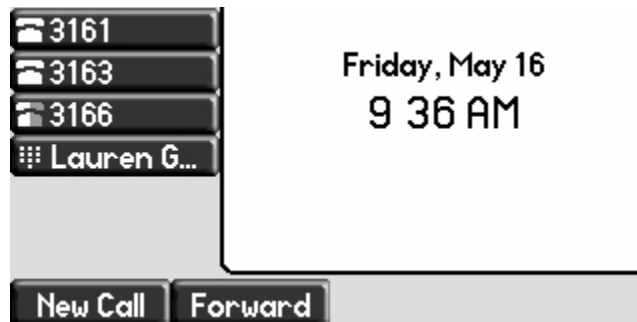

If two phones share a line, an incoming call to that number will cause both phones to ring. The call can be answered on either phone but not both.

Calls on shared lines can be transferred, put on hold, or added to a conference.

Note

Call Forwarding is not available on shared lines.

Do Not Disturb (DND) on shared lines disables the ringing option only, the visual indication is still in place.

Using the Basic Features of Your SoundPoint® IP 560 Desktop Phone

Your SoundPoint IP 560 desktop phone is designed to be used like a regular phone on a public switched telephone network (PSTN). You call place calls, transfer a call to someone else, or conduct a conference call.

At most one active call may be in progress on your phone at any time. The active call is the one that has audio associated with it. There may be multiple other calls:

- On hold
- In an “Incoming call” or “Ringing” state

This chapter provides basic operating instructions for the SoundPoint IP 560 phone. The topics include:

- [Placing Calls](#)
- [Answering Calls](#)
- [Ending Calls](#)
- [Redialing Numbers](#)
- [Placing Calls on Hold](#)
- [Hosting Conference Calls](#)
- [Transferring Calls](#)
- [Forwarding Calls](#)
- [Enabling Do Not Disturb](#)
- [Assigning Speed Dial Keys](#)
- [Using Voice Mail](#)

To customize your phone, refer to [Customizing Your SoundPoint® IP 560 Desktop Phone](#) on page 2-1. To read about the phone's advanced features, refer to [Using the Advanced Features of Your SoundPoint® IP 560 Desktop Phone](#) on page 4-1.

If you require additional information or assistance with your new phone, contact your system administrator.



Placing Calls

You can place a call in many ways using your SoundPoint IP 560 phone:

- using the handset
- using the speakerphone
- using the headset

You can also dial the number first, and then choose the method you will use to speak to the other party.

You can search the call lists, the local contact directory or the corporate directory and dial from the search results page. For more information, refer to [Managing Call Lists](#) on page 2-10 and [Managing Contacts](#) on page 2-11.

During a call, you can alternate between Speakerphone Hands-Free, Headset, or Handset modes by pressing the  or  keys, or picking up the handset.

The call duration of active calls is visible within the active call window on the graphic display. In the figure below, the call to Greg Slowski has lasted 34 seconds so far.



To place a call using the handset:

>> Do the following steps in any order:

- Pick up the handset.
- Dial the number using the dial pad.

**Note**



You can also dial using the SIP URL or IP address. To obtain the IP address of your phone, press the **Menu** key, and then select **Status > Platform > Phone**. The IP address is listed together with other phone information. The maximum URL or IP address length is 32 characters. For example, 10.3.0.42, sip:jane@polycom.com . Press the **URL** soft key and enter the URL or IP address. Use * for "." and # for "@". Then press the **Send** soft key to complete the call.

Your phone may not support SIP URL or IP address dialing. Contact your system administrator.

To place a call using Hands-Free Speakerphone mode:**Note**

If "Handsfree mode disabled" appears on the graphic display after you press the speakerphone key, your system administrator has disabled the speakerphone on your phone.

>> Do one of the following:

- With the handset on-hook, press , , or the **NewCall** soft key to obtain dial tone.

Dial the number using the dial pad.

- With the handset on-hook, dial the number using the dial pad.

Press , , or the **Dial** soft key.

To place a call using the headset:

>> Do one of the following:

- With the optional headset connected, press  or the **NewCall** soft key to obtain dial tone.

Press  .

Dial the desired number using the dial pad.

- With the optional headset connected, dial the desired number using the dial pad.

Press  .

Note

To permanently enable your headset, refer to [Enabling the Headset Memory Mode](#) on page 2-6.

Answering Calls

When you are not in another call, you can answer a call in three ways:

- Using the handset
- Using the speakerphone
- Using the headset

The steps for answering an incoming call when you are in another call are different if your phone is configured for:

- A single Line Key per line

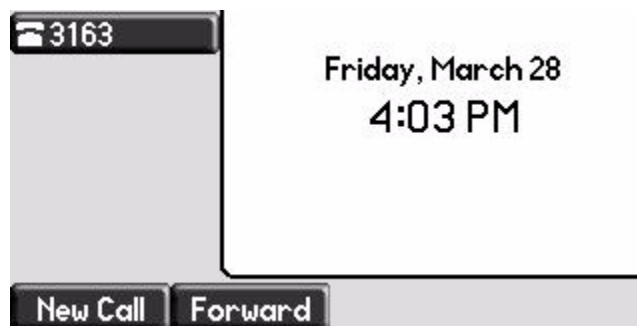

- Multiple Line Keys per line

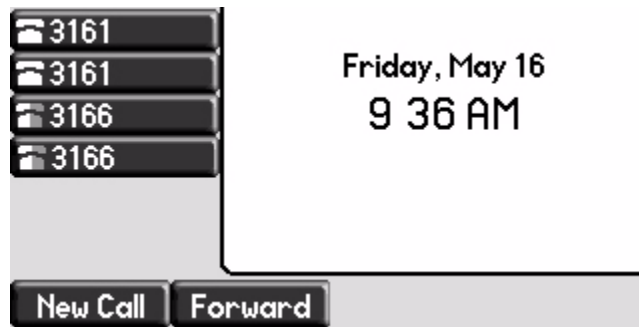

If your phone is configured with multiple call appearances, refer to [Using Multiple Call Appearances](#) on page 4-1 for instructions on how to answer a call.

Note

You can ignore incoming calls by pressing the **Reject** soft key (for private lines) or the **Silence** soft key (for shared lines) or the **Do Not Disturb** key. The Do Not Disturb mode stays active when the call ends and remains active until you press the **Do Not Disturb** key again.

You can forward incoming calls by pressing the **Forward** soft key. For more information, refer to [To forward an incoming call to another party](#): on page 3-21.

When your phone is configured with a silent ring, press the ringing Line key or the **Answer** soft key to answer the call. If your handset is off-hook, the call is routed to the handset. If your handset is on-hook, the call is routed to the speaker.

Answering When Not in Another Call

In all cases, the active call will appear on the graphic display showing call duration and destination.

To answer a call using the handset:



>> Pick up the handset.

To answer a call using Hands-Free Speakerphone mode:

Note

If “Handsfree mode disabled” appears on the graphic display after you press the speakerphone key, your system administrator has disabled the speakerphone on your phone.

>> Do one of the following:

- Press .
- With the handset on-hook, press  (next to the flashing green status indicator).

- Press the **Answer** soft key.

To answer a call using the headset:

>> Press .

If Headset Memory Mode is activated, press  or the **Answer** soft key.

Answering When in Another Call

If you have an active call, and an incoming call arrives on the same line, do one of the following:

- If your phone is configured for a single Line Key per line:
 - You may hear a call waiting tone, and you will see the second call appearance. Caller information for the incoming call appears on the graphic display.
- If your phone is configured for multiple Line Keys per line:
 - You may hear a call waiting tone, the second Line Key indicator fast flashes green, and an incoming call icon appears. Caller information for the second Line Key appears on the bottom line of the graphic display.
- If your phone is configured for shared lines:
 - You may hear a call waiting tone, the second Line Key indicator will fast flash green, and an incoming call icon appears on the second Line Key.

Note

If your phone is configured for shared lines, the **Reject** soft-key is replaced by a **Silence** soft key and there is no the **Forward** soft-key. To stop the incoming call from ringing, press the **Silence** soft key.

To answer an incoming call on a line configured for a single Line Key:

>> Do one of the following:

- Press  or the **Hold** soft key to put the original call on hold.

The incoming call is answered.

- Press  to access the new call.

Press the **Answer** soft key.

The original call is placed on hold.

Note

Incoming calls may be forwarded by pressing the **Forward** soft key. For more information, refer to [To forward an incoming call to another party](#): on page 3-21.

To answer an incoming call on a line configured for multiple Line Keys:

>> Do one of the following:

- Press  next the flashing green indicator.

The first call is placed on hold and the second call become the active call.

- Press  or the **Hold** soft key to place the original call on hold.

Press the **Answer** soft key.

Note

Incoming calls may be forwarded by pressing the **Forward** soft key. For more information, refer to [To forward an incoming call to another party](#): on page 3-21.

To answer an incoming call on a shared line:



1. Answer the incoming call.
2. Press  or the **Hold** soft key.

Anyone on another phone configured to use the same shared line may take the call by selecting the Line Key associated with the call on hold (represented by a flashing red LED).

Ending Calls

To end a call:

>> Do one of the following:

- If you are using the handset, press the **EndCall** soft key or replace the handset.
- If you are using a headset, press .
- If your are using the speakerphone, press .

Redialing Numbers

To redial the last call placed from your phone:

>> Press  .

A call to your last placed call is attempted.

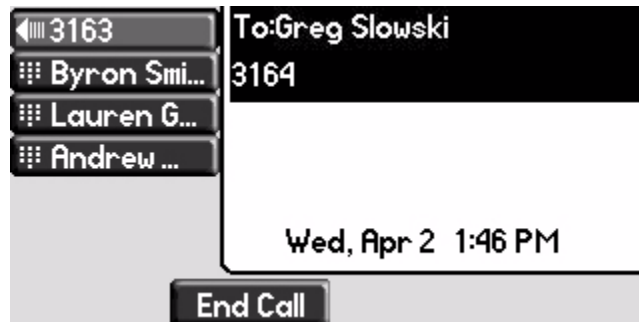

To redial a previously placed call, refer to [Managing Call Lists](#) on page 2-10.

Placing Calls on Hold

During a call, press  or the **Hold** soft key. The hold icon will display on the line key label.





Press  again or the **Resume** soft key to retrieve the call. The registered line icon appears as the line indicator.

Note

The Hold feature typically generates music or a beeping tone. Therefore, avoid putting a conference call on hold.

Multiple Calls on Hold

If multiple calls are on hold on a single Line Key, use  and  to switch between the calls, and then press the **Resume** soft key to retrieve the desired call.

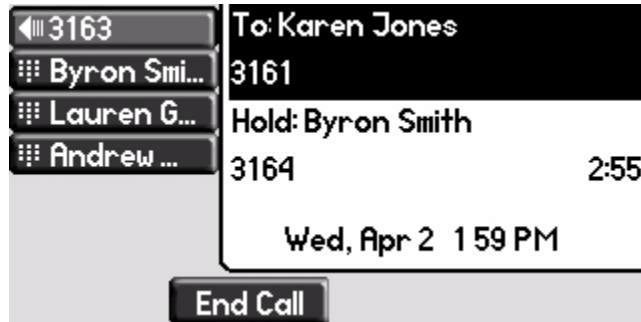

If more than two calls are on hold on a single Line Key, an indication appears on the graphic display, for example "2/3", indicating that this is the second call out of three calls.

If calls are on hold on more than one Line Key, you can view the details of the calls on any Line Key by pressing and holding the Line Key for more than two seconds. If a Line Key is depressed for less than one second, the first call on hold on that Line Key will be retrieved.

Hosting Conference Calls

You can create a conference with other parties using the phone's local conference feature. You can create a conference at any time between an active call and a call on hold (on the same or another line) by pressing the **Join** soft key. The conference management feature allows you to view all parties in a conference call. From the Manage Conference page, you can add, hold, remove, and mute specific conference parties.

Note

The conference management feature is an optional feature and may not be supported on your particular system. For more information, contact your system administrator.

This section provides the following step-by-step instructions:

- [Setting Up Conference Calls](#)
- [Managing Conference Calls](#)
- [Adding Parties to Conference Calls](#)
- [Joining Conferences](#)

- [Splitting Conference Calls](#)
- [Ending Conference Calls](#)

Setting Up Conference Calls

To set up a conference call:

1. Call the first party.

Note

You can either dial the phone number directly or search for the number in the Contact Directory or Call Lists. For more information, refer to [Placing Calls](#) on page 3-2, [Searching for Contacts](#) on page 2-17, or [Managing Call Lists](#) on page 2-11.

2. Press  or the **Confnc** soft key to create a new call.

The active call is placed on hold.

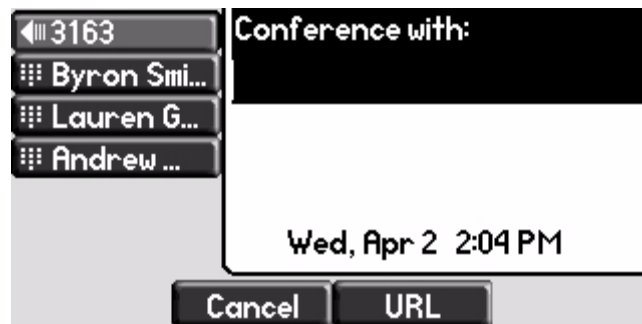

Note

If configured for single key-press conferences, all conference participants hear the dial tone and ringback when the conference host places a call to a new party.

3. Call the second party.

4. When the second party answers, press **Conference** or the **Confrnc** soft key again to join all parties in the conference.



Note

If configured for single key-press conferences, you do not need to press the **Confrnc** soft key again.

5. Press **Conference** or the **Confrnc** soft key to add another party to the conference.

The first and second party are put on hold.

Note

If configured for single key-press conferences, all conference participants hear the dial tone and ringback when the conference host places a call to a new party.

6. Call the third party.
7. After the third party answers, press **Conference** or the **Confrnc** soft key again to join all parties in the conference.

Note

If configured for single key-press conferences, you do not need to press the **Confrnc** key again.

A conference similar to this one will now exist.

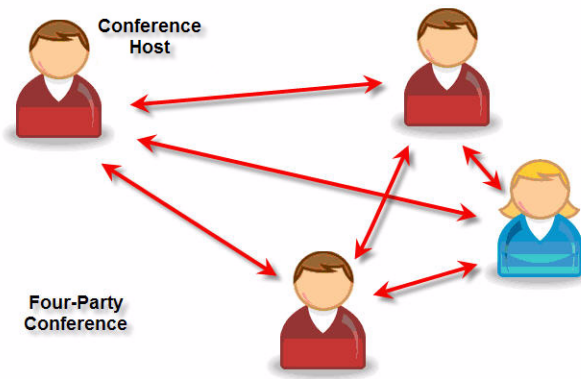

- Repeat steps 5 to 7 until you have added all intended parties.

Managing Conference Calls

To manage a conference call:

You are currently in a conference call.



- Press the **Manage** soft key.

The Manage Conference page appears.

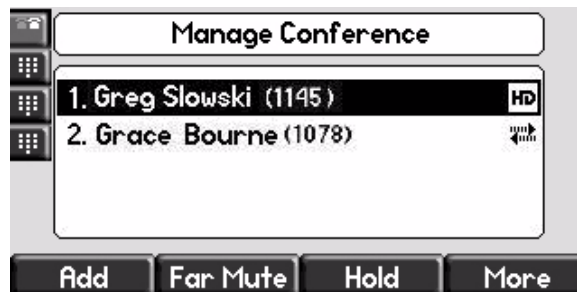

Press the **More** soft key to see the **Remove**, **Info**, and **Back** soft keys.

Press the **Info** soft key to view more information about the selected party.

Press the **Back** soft key to exit the conference management feature.

2. Do one of the following:

- To add a new party, press the **Add** soft key.

Call another party as you would using **Conference** or the **Confnc** soft key (outside the conference management feature). The other parties are put on hold.

After the new party answers, press **Conference** again to join all parties in the conference.

Note

The **Add** soft key appears only if you can add more parties to the conference call. Your system administrator determines the maximum number of conference participants. The default number is three. For more information, contact your system administrator

- To mute a party, select the party, then press the **Far Mute** soft key.



The muted party can hear all parties, but no party can hear the muted party.

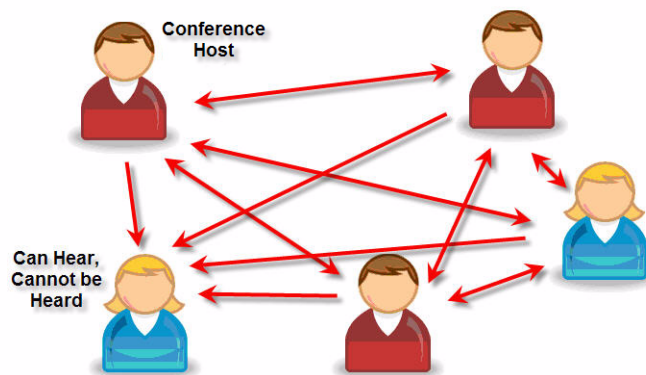

If you press  instead of the **Far Mute** soft key, all other parties can hear each other, but they cannot hear you.

Press the **UnMute** soft key to un-mute the party.

- To place a party on hold, select the party, and then press the **Hold** soft key.

The held party cannot hear any parties and no party can hear the held party.

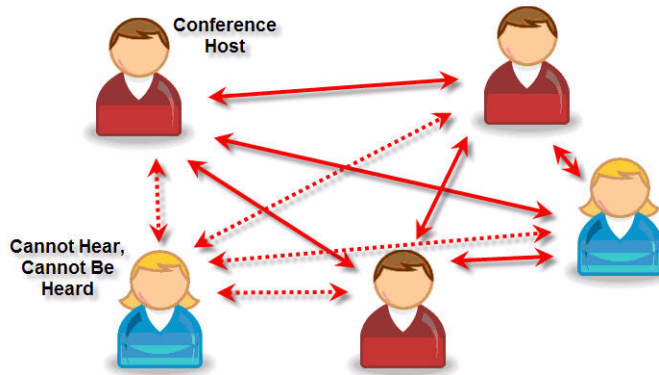

Press the **Resume** soft key to return the party to the conference.

If the held party presses  on their phone, the party will remain on hold within the conference even if you press the **Resume** soft key.

- To remove a party from the conference, press the **Remove** soft key.
The party is removed from the conference. To return the party to the conference, press the **Add** soft key (refer to the first optional step above).

Adding Parties to Conference Calls

To add a party to a conference call using the Join soft key:

You are currently hosting a conference call between a number of parties.

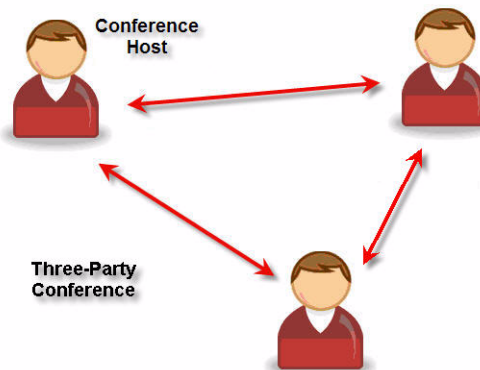

To add a party to a conference call using the Join soft key:

1. From the Manage Conference page, press  or the **Hold** soft key.
The other parties in the conference call are placed on hold.

Note

If configured for local conference hold, the other parties in the conference call can continue to speak with each other while you place the new call.

2. Press the **New Call** soft key.
3. Place a call to a new party.
4. After the new party answers, press the **Join** soft key.
All parties in the conference call can now hear each other.

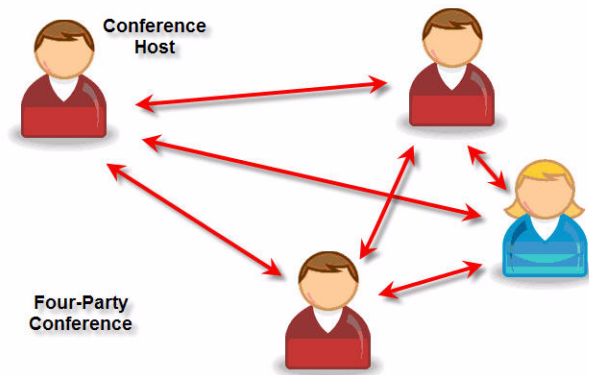

Joining Conferences

To join two conferences:

Previously you set up two separate conference calls between a number of parties. Only one conference can be active at a time.

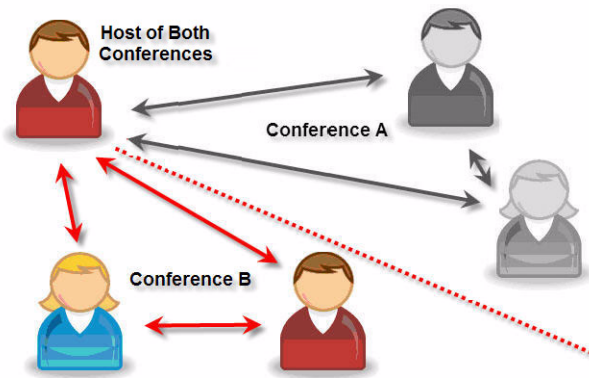

1. From the idle display, press the **Join** soft key.
Both conferences are joined into a single five-way conference.

Splitting Conference Calls

To split a conference call:

>> From the Active Conference page, press the **More** soft key, and then the **Split** soft key to split the conference.

All calls are split into individual calls and put on hold.

Ending Conference Calls

To end a conference call:

>> From the Active Conference page, press the **EndCall** soft key or hang up.

The other parties will continue to be connected.

Transferring Calls

A call can be transferred in one of three ways:

- Consultative transfer – The party to whom you want to transfer the call answers their phone before you transfer the call or hang up. You can consult with them before completing the transfer.
 - Refer to [Performing a Consultative Transfer](#) on page 3-17.
- Blind transfer – The call is automatically transferred after you dial the number of the party to whom you want to transfer the call.
 - Refer to [Performing a Blind Transfer](#) on page 3-18.
- Attended transfer – The parties are automatically connected to each other after you exit the conference.
 - Set up a conference call and then end your participation. For more information, refer to [Hosting Conference Calls](#) on page 3-9.

Performing a Consultative Transfer

To transfer a call:

1. During a call, press the  or the **Transfer** soft key.
The active call is placed on hold.

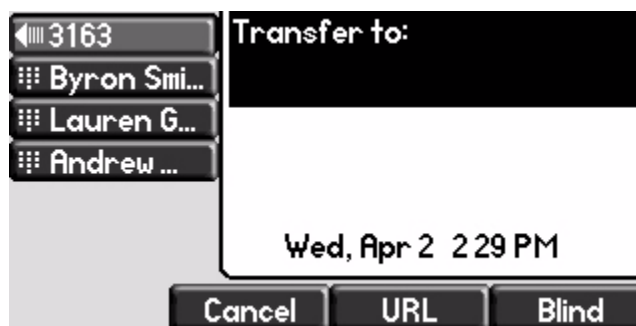

2. Do one of the following:
 - Enter the number to which you want to transfer the call.
 - Refer to [Placing Calls](#) on page 3-2.

3. As soon as you hear the ring-back sound or after the party answers (and you speak to the party), press  or the **Trnsfer** soft key.



You can talk privately to the party to which you are transferring the call before the transfer is completed.

If you are using a handset, the transfer can be completed by putting the handset on the cradle.

You can cancel the transfer before the call connects by pressing the **Cancel** soft key.

Performing a Blind Transfer

To perform a blind transfer:

1. During a call, press  or the **Trnsfer** soft key.
2. Press the **Blind** soft key.



3. Do one of the following steps:
 - Enter the number to which you want to transfer the call.
 - Refer to [Placing Calls](#) on page 3-2.

At this point, the call is connected to the number to which you are transferring them.

Forwarding Calls

You can configure your phone so that all incoming calls are forwarded to another party (refer to [Static Forwarding](#)). You can also forward calls while your phone rings (refer to [Dynamic Forwarding](#)).

All incoming calls can be forwarded to another party while Do Not Disturb is enabled on your phone. For more information, contact your system administrator.

Note

Call Forwarding is not available on shared lines.

This feature is local to the phone, and may be overridden by call server settings. For more information, contact your system administrator.

Static Forwarding

To forward all incoming calls to another party:

1. From the idle display, press the **Forward** soft key.

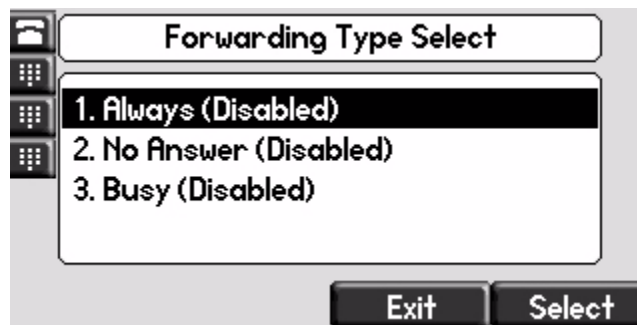

2. (Optional.) If multiple lines are configured on your phone, select the line to forward from the list using \triangle and ∇ .
3. Using \triangle and ∇ , select the forwarding type you want to change, and then press the **Select** soft key. The options are:
 - **Always** – To forward all incoming calls
 - **No Answer** – To forward unanswered incoming calls
 - **Busy** – To forward calls that arrive when you are already in a call
4. Depending on your selection:

- a If you selected **Always**, enter a number to forward all future incoming calls to.

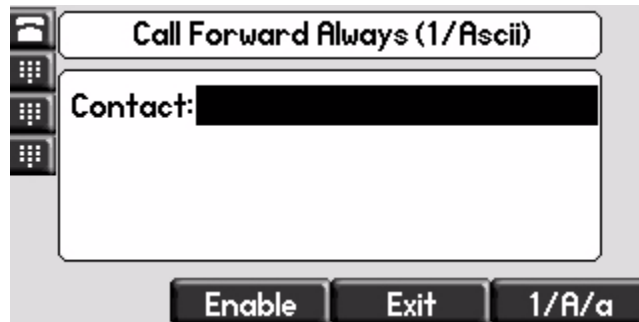

- b If you selected **No Answer**, enter a number to forward all unanswered incoming calls to and how many rings to wait before forwarding (one ring is approximately six seconds). A value of 2 is recommended.

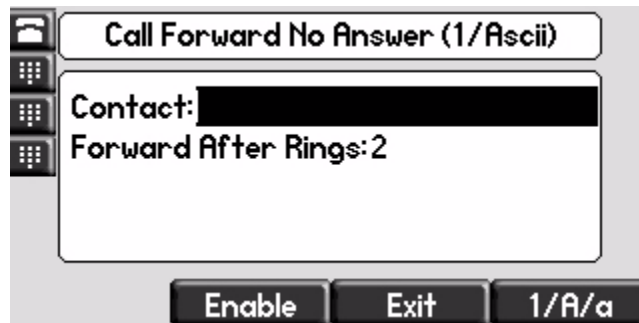

- c If you selected **Busy**, enter a number to forward all future incoming calls to when you are already in another call.

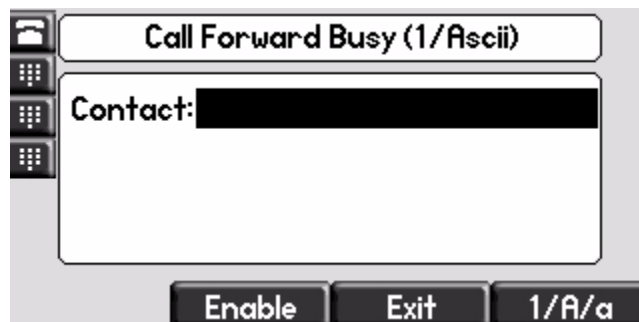





Note

You can also enter the SIP URL or IP address. For more information on using a SIP URL or IP address, refer to [Placing Calls](#) on page 3-2

5. Select the **Enable** soft key to confirm call forwarding.

A moving arrow appears on the line label to confirm call forwarding is enabled.

To disable call forwarding:

1. From the idle display, press the **Forward** soft key.
2. (Optional.) If multiple lines are configured on your phone, select the line to forward from the list using  and .
3. Using  and , select the forwarding type you want to change and then press the **Select** soft key.
4. Press the **Disable** soft key.

The idle display returns and the regular icon appears as the line indicator.

Dynamic Forwarding

To forward an incoming call to another party:

1. When the phone rings, press the **Forward** soft key.
2. Enter a number to forward the incoming call to.
3. Press the **Enable** soft key.

The incoming call is forwarded to the other party. If call forwarding is disabled, all future calls will not be forwarded and forwarding will remain disabled.

Enabling Do Not Disturb

To prevent the phone ringing (from incoming calls), you can select Do Not Disturb.

Note

This feature is local to the phone, and may be overridden by call server settings. For more information, contact your system administrator.

To enable Do Not Disturb:

>> Press **Do Not Disturb**.

A flashing icon and text on the graphic display indicate that Do Not Disturb is enabled.

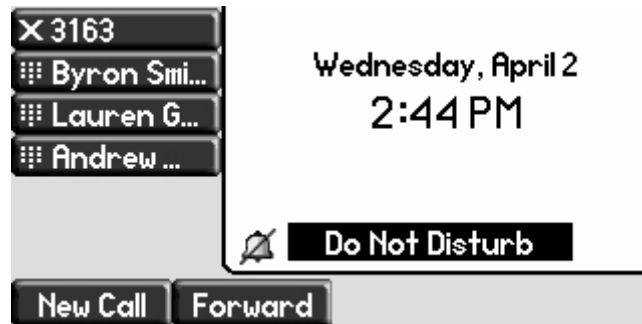



Calls received while Do Not Disturb is enabled are logged in the Missed Calls list unless configured to be forwarded to another party by your system administrator.

To disable Do Not Disturb:

>> Press **Do Not Disturb** again.

Multiple Lines and Do Not Disturb

If multiple lines are configured on your phone, Do Not Disturb can be set on a line-by-line basis from the menu using  and . For more information, contact your system administrator. When Do Not Disturb is enabled for a particular line, a flashing "X" displays beside the line indicator.

Assigning Speed Dial Keys

You can associate contacts with Line Keys for single touch dialing of frequently used numbers. Speed Dial entries are consecutively placed next to assigned Line Keys on the phone. When a new entry is added to the Contact Directory, it is automatically assigned the next available speed dial index and the next available line key.

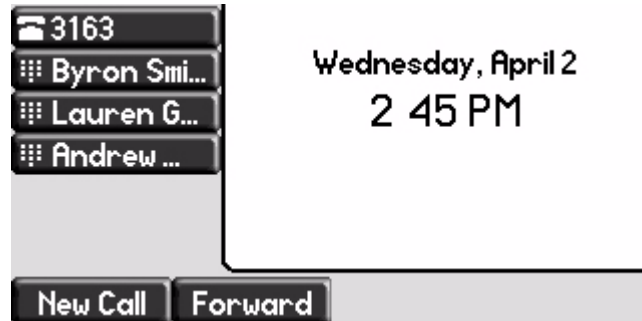

In the figure below, the phone has one line key, and three available speed dial keys (assigned to Byron, Lauren, and Andrew). To dial Byron, Lauren, or Andrew, press the associated line key.





Note

To quickly access a list of speed dial index numbers, press the **Up Arrow** key from the idle display.

To add or edit a speed dial index for an existing contact:

1. Press .
2. Select **Contact Directory**.
3. Use  and  to highlight the contact.
You can also use the * key to page up and the # key to page down.
4. Press the **Edit** soft key.



5. Do one of the following:
 - Enter the next available speed dial index.
 - Delete the existing speed dial index by using  followed by , and then enter a new speed dial index.

Valid speed dial index values are from 1 to 9999. If you enter a speed dial index that already exists, “Speed dial index already exists” appears. If you enter an invalid value, “Speed dial index invalid” appears.

6. Press the **Save** or **Cancel** soft keys to accept or cancel changes.
7. Press  to return to the idle display.

To assign a new speed dial key:

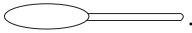
1. Press and hold an unassigned .
A new empty entry in the contact directory is automatically opened allowing contact information to be added.
2. Press the **More** soft key, and then press the **Add** soft key.
3. (Optional.) Enter contact information.
Use the **1/A/a** soft key to select between numeric and upper/lower case alphanumeric modes.
Use the **Encoding** soft key to access special characters in other languages.
4. Do one of the following:
 - Enter a contact number.
The number must be unique (not already in the directory).
 - Enter a contact string where:
The number must be unique
“p” indicates 1 second delay
“,” indicates a 2 second delay

For example, your organization voice mail system is accessible through 7700 and your voice mail password is 2154. If you enter “7700,,,2154” as the contact string, you could use the speed dial key to access your voice mail.
5. Change the Speed Dial Index field.
The index can be any value between the next available index value and the maximum (value of 9999).



Polycom recommends that you assign speed dial index values consecutively. For example, if you assign the third Line Key to the speed dial index value “2”, assign the fourth Line Key to the speed dial index value “3”.

6. Press the **Save** or **Cancel** soft keys to accept or cancel changes.
7. Press  to return to the idle display.

Using Voice Mail

Note

Voice mail is an optional feature configured on the call server and may not be supported on your particular system. For more information, contact your system administrator.

Screen options may vary with your application. Voice mail may be accessible with a single key press. Contact your system administrator about this option.

You can access voice mail messages from your phone. Your voice mail is saved in a centralized location.

Your phone indicates the presence of new voice mail messages by a flashing Message Waiting Indicator LED on the front of the phone and a visual notification on the screen. If your phone has multiple lines, an individual line indicator icon indicates voice mail messages on that line.

A stutter dial tone in place of normal dial tone indicates that one or more voice messages are waiting at the message center.

To listen to voice messages:

1. Press  .

If multiple lines are configured on your phone, select the line to retrieve messages from.

2. Follow voice or visual prompts on the screen to retrieve your messages.

Using the Advanced Features of Your SoundPoint® IP 560 Desktop Phone

This chapter provides operating instructions for the advanced features of the SoundPoint IP 560 phone. This chapter contains instructions on:

- [Using Multiple Call Appearances](#)
- [Using Text Messaging](#)
- [Using Buddy Lists](#)
- [Restarting Your Phone](#)

To customize your phone, refer to [Customizing Your SoundPoint® IP 560 Desktop Phone](#) on page 2-1. To read about the phone's basic features, refer to [Using the Basic Features of Your SoundPoint® IP 560 Desktop Phone](#) on page 3-1.

If you require additional information or assistance with your new phone, contact your system administrator.

Using Multiple Call Appearances

When multiple call appearances is set up, you can see information for more than one call at one time. For example, if you have an active call, you can see information for an incoming call as well.

For example, the following figure shows an active call with Greg Slowski on line 6721.



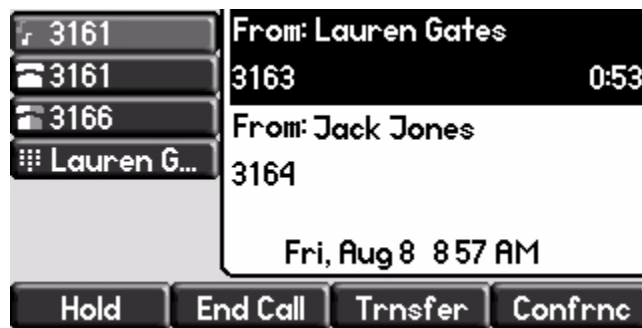

The following figure shows an incoming call from 1-800-765-9266 on the same line.



To answer an incoming call when configured for multiple call appearances:

>> Do one of the following:

- Press  or the **Hold** soft key to place the original call on hold.
- Press  to access the new call.

Answer the incoming call.

This original call is placed on hold and the incoming call becomes the active call.

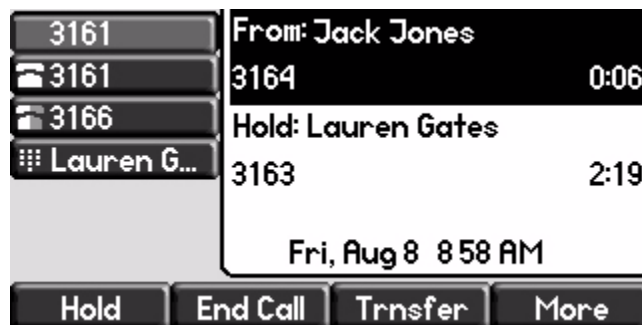

Your phone can display two call appearances at one time. If more than two calls are taking place on the same line, a counter displays on the display. Use the down arrow to access additional calls, or “appearances”.

To place an additional call on the same line, place the active call on hold, and then press the **New Call** soft key.





Using Text Messaging

You can send and receive text messages using your phone. SIP Instant (Text) Messaging is supported in real-time. Received messages will be indicated by a flashing Message Waiting Indicator LED on the front of the phone and, optionally, a visual notification on the graphic display.

Note

The text messaging feature is an optional feature and may not be supported on your particular system. If it is supported, screen options may vary with your application. Text messaging may be accessible with a single key press. For more information, contact your system administrator.

To read text messages:

- Do one of the following steps:
 - Press  .
Select **Instant Messages**.
 - Press  .
Select **Features > Messages > Instant Messages**.
 - Press the **InstMsg** soft key.
- (Optional.) If multiple lines are configured on your phone, select from which line messages are to be retrieved from the list using  and  .
Messages appear first to last in sent order.
- (Optional.) Do one of the following:
 - Press the **Next** or **Prev** soft keys to cycle through messages in order.
 - Press the **More** soft key to access the **Delete**, **Reply**, and **New** soft keys.
- Press  to return to the idle display.

To send a text message:

1. Do one of the following:

- Press  .



Select **Instant Messages**.

Note

Screen options may vary with your application. Voice Mail may be accessible with a single key press. Contact your system administrator about this option.

- Press  .

Select **Features > Messages > Instant Messages**.

2. (Optional) If multiple lines are configured on your phone, first select from which line to send the message from the list using  and .
3. Press the **New** soft key.
4. Enter the number.

Use the **1/A/a** soft key to alternate between numeric and upper/lower case alphanumeric modes.

Note

You can also enter the SIP URL or IP address. For more information on dialing with SIP URL or IP address, refer to [Placing Calls](#) on page 3-2.

5. Press the **Ok** soft key.
6. Do one of the following:
 - Press the **Select** soft key to choose from various pre-scripted short messages.
 - Press the **Edit** soft key to compose a custom message.

Use dial pad keys to cycle through the character set. Use keys 1, *, 0, and # to select special characters.
7. Press the **Send** soft key when finished.
8. Press  to return to the idle display.

Using Buddy Lists

A buddy list is a list of users/devices whose status or “presence” you can monitor. Users update their presence setting (for example, “Be right back”, “Busy”, or “Out to lunch”), and you can view their status in real-time from your phone.

Your phone can “watch” the status of up to eight other phones or 48 buddies. These other phones form your “buddy list”. Your phone displays the status of your buddies in real time. Your phone can be “watched” by up to eight other phones.

If your SoundPoint IP 560 phone is configured to work with Microsoft Live Communications Server 2005, the behavior of the presence setting and buddy lists is different. For more information, contact your system administrator.



Presence Settings

To view and change your presence settings:

1. Do one of the following:

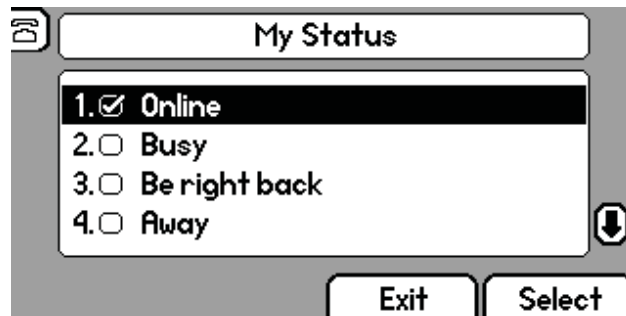
- Press  .
Select **Features > Presence > My Status**.
- Press the **MyStat** soft key.



2. Use  or  to scroll through the list, and then press the **Select** soft key to select your new status.

The phones watching your status will now display your new status.







Presence information will also be sent to watching phones when you go off-hook or enable Do Not Disturb.

Managing Buddies





Note

The instructions in this section do not apply if your call server is Microsoft Live Communications Server 2005. In that case, refer to the following section, [Integrating With Microsoft Live Communications Server 2005](#).

To add or delete a contact from your buddy list:

1. Press .
2. Select **Contact Directory**.
3. Use  and  to highlight the contact.
You can also use the * key to page up and the # key to page down.
4. Press the **Edit** soft key.
5. Scroll to the Watch Buddy field.
6. Use  and  to select Enabled.
When Watch Buddy is enabled, the contact is added to your buddy list.
When Watch Buddy is disabled, the contact is removed from your buddy list.
The default for Watch Buddy is Disabled.
7. Press the **Save** or **Cancel** soft keys to accept or cancel changes.
8. Press  to return to the idle display.

To block or unblock a contact from your buddy list:

1. Press .
2. Select **Contact Directory**.
3. Use  and  to highlight the contact.
You can also use the * key to page up and the # key to page down.
4. Press the **Edit** soft key.
5. Scroll down to the Block Buddy field.
6. Use  and  to select Enabled.
When Block Buddy is enabled, the contact cannot watch your phone.
When Block Buddy is disabled, the contact can watch your phone.
The default for Block Buddy is Disabled.
7. Press the **Save** or **Cancel** soft keys to accept or cancel changes.

8. Press  to return to the idle display.

Integrating With Microsoft Live Communications Server 2005



Your phone can be configured to work with Microsoft Live Communications Server 2005 and communicate with others using Microsoft Office Communicator and Windows Messenger. From your phone, you can invite, join, control, and monitor integrated multipoint audio and video conferences.

Any contacts added through your buddy list will appear as a contact in Microsoft Office Communicator and Windows Messenger. Any contacts added as a contact in Microsoft Office Communicator and Windows Messenger will appear in your buddy list.



To view and change your presence, refer to [To view and change your presence settings](#): on page 4-5.



For more information, contact your system administrator.

To add a contact to your buddy list:

1. Press .
2. Select **Features > Presence > Buddy Status**.
3. Press the **More** soft key.
4. Press the **Add** soft key.
5. Enter the number of the contact.
6. Press the **Submit** soft key.
7. Press  to return to the idle display.

To view and change your privacy list:

1. Press .
2. Select **Features > Presence > Buddy Status > Privacy List**.
3. Use  and  to scroll through the list to find the contact.
4. Press the **Edit** soft key.
5. Scroll down to the Access field.

6. For Access, use  and  to select Enabled.

When Access is enabled, you are allowing the contact to see your presence. When Access is disabled, you are disallowing the contact from seeing your presence.

The default for access is Disabled.

7. Press  to return to the idle display.

For more information on contacting buddies, refer to [Placing Calls](#) on page 3-2 or the Microsoft Office Communicator and Windows Messenger documentation.

Restarting Your Phone

Periodically, you may need to restart your phone so your phone can accept a new configuration.

Note

If your phone malfunctions, you may be able to restore normal operation without restarting it. Before you restart your phone, contact your system administrator.

Note

Call lists are automatically cleared when you restart the phone.

To restart the phone:

1. Press  .
2. Select **Settings > Basic > Restart Phone**.
“Are you sure?” appears on the graphic display.
3. If you still want to restart your phone, press the **Yes** soft key.
The restart process begins. The process ends when the idle display appears.

Troubleshooting Your SoundPoint® IP 560 Desktop Phone

This chapter contains general troubleshooting information to help you solve any problems you might encounter when you use your SoundPoint IP 560 phone. The tables in this chapter list possible trouble symptoms, the likely causes of these problems, and the recommended corrective actions to take.

- [Power and Startup](#)
- [Controls](#)
- [Access to Screens and Systems](#)
- [Calling](#)
- [Displays](#)
- [Audio](#)

To obtain more detailed troubleshooting information, you can access certain menus on your phone that test your phone hardware. For more information, see [Testing Phone Hardware](#) on page 5-8.

If you require additional assistance, contact your system administrator.

Power and Startup

Symptom	Problem	Corrective Action
There are power issues.	The SoundPoint IP 560 phone has no power.	Do one of the following: <ul style="list-style-type: none">• Verify that no lights appear on the phone when it is powered up.• Check if the phone is properly plugged into a functional AC outlet.• Make sure that the phone isn't plugged into a plug controlled by a light switch that is off.• If the phone is plugged into a power strip, try plugging it directly into a wall outlet instead.• Try the phone in another room where the electricity is known to be working on a particular outlet.

Controls

Symptom	Problem	Corrective Action
The dial pad does not work.	The dial pad on the SoundPoint IP 560 phone does not respond.	<p>Do one of the following:</p> <ul style="list-style-type: none"> • Check for a response from other feature keys or from the dial pad. • Place a call to the phone from a known working telephone. Check for display updates. • Check if the LAN port is active or inactive. Press the Menu key, and then select Status > Network > Ethernet. From the Ethernet page, scroll to the LAN port field and verify that it is active. • Check the termination at the switch or hub end of the network LAN cable. Ensure that the switch/hub port connected to the telephone is operational (if not accessible, contact your system administrator). • Before restarting your phone (refer to * on page *), contact your system administrator. Your system administrator may want to troubleshoot your phone in more detail before restarting the phone and losing current status information.

Access to Screens and Systems

Symptom	Problem	Corrective Action
<p>There is no response when you press a feature key.</p>	<p>The SoundPoint IP 560 phone is not in an active state.</p>	<p>Do one of the following:</p> <ul style="list-style-type: none"> • Press the keys more slowly. • Check with your system administrator to see if the key has been mapped to a different function or is disabled. • Place a call to the phone to check that inbound call display and ringing is normal. If successful, try to press feature keys within the call to access the Main Menu, for example. • To confirm that the line is active, press the Menu key, and then select Status > Lines > Line Information. From the Line Information page, verify that your phone line is registered. • To attempt re-registration to the call server, reboot your phone. Contact your system administrator.
<p>The screen shows “Network Link is Down”.</p>	<p>The LAN cable is not properly connected.</p>	<p>Do one of the following:</p> <ul style="list-style-type: none"> • Check termination at the switch or hub (furthest end of the cable from the phone). • Check that the switch or hub is operational (flashing link/status lights) or contact your system administrator. • Check if the LAN port is active or inactive. Press the Menu key, and then select Status > Network > Ethernet. From the Ethernet page, scroll to the LAN port field and verify that it is active. • To attempt re-registration to the call server, reboot your phone. Contact your system administrator.

Calling

Symptom	Problem	Corrective Action
There is no dial tone.	Power is not correctly applied to the SoundPoint IP 560 phone.	<p>Do one of the following:</p> <ul style="list-style-type: none"> • Check that the screen is illuminated. • Make sure the LAN cable is inserted properly at the back of the phone (try unplugging and re-inserting the cable). • If using Power over Ethernet (PoE), have your system administrator check that the switch is supplying power to the phone.
	Dial tone is not present on one of the audio modes.	<p>Do one of the following:</p> <ul style="list-style-type: none"> • Switch between Handset, Headset (if present) or Hands-Free Speakerphone to see if the dial tone is present for one of audio modes. • If the dial tone exists on another audio mode, connect a different handset or headset to isolate the problem.

Symptom	Problem	Corrective Action
The phone does not ring.	Ring setting or volume is low.	Do one of the following: <ul style="list-style-type: none"> • Adjust the ringing level from the front panel using the volume up/down keys. • Check status of Handset, Headset (if connected), and Hands-Free Speakerphone.
	Outbound or inbound calling is unsuccessful.	Do one of the following: <ul style="list-style-type: none"> • Place a call to the phone under investigation. Check that the screen indicates incoming call information. • Lift the handset. Ensure the dial tone is present and place a call to another extension or number. Check that the screen changes in response.
	You turned off the ringer.	Do one of the following: <ul style="list-style-type: none"> • During an incoming call, lift the handset, press the Speakerphone key, or press the Headset key to obtain a dial tone. • Press the ringing Line Key or the Answer soft key to answer the call.
"Service Unavailable" appears on the screen.	The user pressed the New Call soft key, dialed a number with the handset on-hook, or attempted to make a call from the contact directory when the phone was not registered.	Check with your system administrator to see when your phone will be registered.

Displays

Symptom	Problem	Corrective Action
<p>There is no display. The display is incorrect. The display has bad contrast.</p>	<p>Power is not correctly applied to the SoundPoint IP 560 phone.</p>	<p>Do one of the following:</p> <ul style="list-style-type: none"> • Check that the screen is illuminated. • Make sure the LAN cable is inserted properly at the back of the phone (try unplugging and re-inserting the cable). • If using Power over Ethernet (PoE), have your system administrator check that the switch is supplying power to the phone.
	<p>The contrast needs adjustment.</p>	<p>Do one of the following:</p> <ul style="list-style-type: none"> • Refer to Changing the Display Contrast on page 2-3. • To obtain a default level of contrast, restart the phone. (Refer to * on page *).
	<p>Outbound or inbound calling is unsuccessful.</p>	<p>Do one of the following:</p> <ul style="list-style-type: none"> • Place a call to the phone under investigation. Check that the screen indicates incoming call information. • Lift the handset. Ensure the dial tone is present and place a call to another extension or number. Check that the screen changes in response.
<p>The display flickers.</p>	<p>A certain type of older fluorescent lighting causes the display to appear to flicker.</p>	<p>Do one of the following:</p> <ul style="list-style-type: none"> • Move the SoundPoint IP 560 SIP phone away from the lights. • Replace the lights.

Audio

Symptom	Problem	Corrective Action
There is no audio on the headset.	The connections are not correct.	Do one of the following: <ul style="list-style-type: none">• Ensure the headset is plugged into the jack marked Headset at the rear of the phone.• Ensure the headset amplifier (if present) is turned on and/or the volume is correctly adjusted. If the amplifier uses batteries, check that they are fully charged.

Testing Phone Hardware

Your system administrator may ask you to access a diagnostics menu on your phone to test your phone hardware. From the diagnostics menu, you can test your phone's microphones, speaker, handset, third-party headset (if present), keypad mappings, and LCD display. See your system administrator for instructions on how to perform these tests.

To test your phone hardware:

>> Press , and then select **Status > Diagnostics > Test Hardware > Audio Diagnostics, Keypad Diagnostics, or Display Diagnostics.**

Regulatory Notices

Service Agreements

Please contact your Polycom Authorized Reseller for information about service agreements applicable to your product.

Governing Law

This Limited Warranty and Limitation of Liability shall be governed by the laws of the State of California, U.S.A., and by the laws of the United States, excluding their conflicts of laws principles. The United Nations Convention on Contracts for the International Sale of Goods is hereby excluded in its entirety from application to this Limited Warranty and Limitation of Liability.

All rights reserved under International and Pan-American Copyright Conventions. No part of the contents of this manual may be copied, reproduced, or transmitted in any form or by any means, or translated into another language or format, in whole or part, without written consent from Polycom, Inc. Do not remove (or allow anybody else to remove) any product identification, copyright or other notices.

Limitations of Liability

LIMITATION OF LIABILITY. TO THE FULL EXTENT ALLOWED BY LAW, POLYCOM EXCLUDES FOR ITSELF AND ITS SUPPLIERS ANY LIABILITY, WHETHER BASED IN CONTRACT OR TORT (INCLUDING NEGLIGENCE), FOR INCIDENTAL, CONSEQUENTIAL, INDIRECT, SPECIAL, OR PUNITIVE DAMAGES OF ANY KIND, OR FOR LOSS OF REVENUE OR PROFITS, LOSS OF BUSINESS, LOSS OF INFORMATION OR DATA, OR OTHER FINANCIAL LOSS ARISING OUT OF OR IN CONNECTION WITH THE SALE, INSTALLATION, MAINTENANCE, USE, PERFORMANCE, FAILURE, OR INTERRUPTION OF ITS PRODUCTS, EVEN IF POLYCOM OR ITS AUTHORIZED RESELLER HAS BEEN ADVISED OF THE POSSIBILITY OF SUCH DAMAGES, AND LIMITS ITS LIABILITY TO REPAIR, REPLACEMENT, OR REFUND OF THE PURCHASE PRICE PAID, AT POLYCOM'S OPTION. THIS DISCLAIMER OF LIABILITY FOR DAMAGES WILL NOT BE AFFECTED IF ANY REMEDY PROVIDED HEREIN SHALL FAIL OF ITS ESSENTIAL PURPOSE.

Polycom Limited Warranty and Limitation Liability

LIMITED WARRANTY. Polycom warrants to the end user (“Customer”) that this product is expected to be free from defects in workmanship and materials, under normal use and service, for one year from the date of purchase from Polycom or its authorized reseller.

Polycom’s sole obligation under this express warranty is at Polycom’s option and expense, to repair the defective product or part, deliver to Customer an equivalent product or part to replace the defective item, or if neither of the two foregoing options are reasonably available, Polycom may, on its sole discretion, refund to Customer the purchase price paid for the defective product. All products that are replaced will become the property of Polycom. Replacement products or parts may be new or reconditioned.

Polycom is expected to warrant any replaced or repaired product or part for ninety (90) days from shipment, or the remainder of the initial warranty period, whichever is longer. Products returned to Polycom must be sent prepaid and packaged appropriately for safe shipment, and it is recommended that they be insured or sent by a method that provides for tracking of the package. Responsibility for loss or damage does not transfer to Polycom until the returned item is received by Polycom. The repaired or replaced item will be shipped to Customer, at Polycom’s expense, not later than thirty (30) days after Polycom receives the defective product, and Polycom will retain risk of loss or damage until the item is delivered to Customer.

The product software comes with 90-day software warranty, providing for software updates (minor releases/bug fixes). To continue to receive support, purchasing a maintenance contract is the most economical solution.

Exclusions

Polycom will not be liable under this limited warranty if its testing and examination disclose that the alleged defect or malfunction in the product does not exist or results from:

- Failure to follow Polycom’s installation, operation, or maintenance instructions.
- Unauthorized product modification or alteration.
- Unauthorized use of common carrier communication services accessed through the product.
- Abuse, misuse, negligent acts or omissions of Customer and persons under Customer’s control; or
- Acts of third parties, acts of God, accident, fire, lightening, power surges or outages, or other hazards.

Warranty Exclusive

IF A POLYCOM PRODUCT DOES NOT OPERATE AS WARRANTED ABOVE, CUSTOMER’S SOLE REMEDY FOR BREACH OF THAT WARRANTY SHALL BE REPAIR, REPLACEMENT, OR REFUND OF THE PURCHASE PRICE PAID, AT POLYCOM’S OPTION. TO THE FULL EXTENT ALLOWED BY LAW, THE FOREGOING WARRANTIES AND REMEDIES ARE EXCLUSIVE AND ARE IN LIEU OF ALL OTHER WARRANTIES, TERMS, OR CONDITIONS, EXPRESS OR IMPLIED, EITHER IN FACT OR BY OPERATION OF LAW, STATUTORY OR OTHERWISE, INCLUDING WARRANTIES, TERMS, OR CONDITIONS OF MERCHANTABILITY, FITNESS FOR A PARTICULAR PURPOSE, SATISFACTORY QUALITY, CORRESPONDENCE WITH DESCRIPTION, AND NON-INFRINGEMENT, ALL OF WHICH ARE EXPRESSLY DISCLAIMED. POLYCOM NEITHER ASSUMES NOR AUTHORIZES ANY OTHER PERSON TO ASSUME FOR IT ANY OTHER LIABILITY IN CONNECTION WITH THE SALE, INSTALLATION, MAINTENANCE OR USE OF ITS PRODUCTS.

Safety and Compliance**Part 15 FCC Rules**

This device is compliant with Part 15 of the FCC Rules. Operation is subject to the following two conditions:

1. This device may not cause harmful interference, and
2. This device must accept any interferences received, including interference that may cause undesired operation.

Class B Digital Device or Peripheral

Note: This equipment is tested and complies with the limits for a Class B digital device, pursuant to Part 15 of the FCC Rules. These limits are designed to provide reasonable protection against harmful interference in a residential installation. This equipment generates, uses, and can radiate radio frequency energy and, if not installed and used in accordance with the instructions, may cause harmful interference to radio communications. However, there is no guarantee that interference will not occur in a particular installation. If this equipment does cause harmful interference to radio or television reception, which can be determined by turning the equipment off and on, the user is encouraged to try to correct the interference by one or more of the following measures:

1. Reorient or relocate the receiving antenna.
2. Increase the separation between the equipment and receiver.
3. Connect the equipment into an outlet on a circuit different from that to which the receiver is connected.
4. Consult the dealer or an experience radio/TV technician for help.

Modifications

In accordance with Part 15 of the FCC Rules, the user is cautioned that any changes or modifications not expressly approved by Polycom, Inc. could void the user's authority to operate the equipment. This equipment may not be used on a coin service or party line.

Installation Instructions

Installation must be performed in accordance with all relevant national wiring rules.

L'Installation doit être exécutée conformément à tous les règlements nationaux applicable au filage électrique.

When using PoE (Power over Ethernet), the equipment is to be connected only to PoE networks without connections to the outside plant.

Plugs Acts as Disconnect Device

The socket outlet to which this apparatus is connected must be installed near the equipment and must always be readily accessible.

La prise électrique à laquelle l'appareil est branché doit être installée près de l'équipement et doit toujours être facilement accessible.

Industry Canada (IC)

This Class [B] digital apparatus complies with Canadian ICES-003.

Cet appareil numérique de la classe [B] est conforme à la norme NMB-003 du Canada.

Safety and Compliance (continued)

CE and VCCI Mark

This SoundPoint IP 560 SIP is marked with the CE mark. This mark indicates compliance with EC Directives 2006/95/EC and 2004/108/EC. A full copy of the Declaration of Conformity can be obtained from Polycom Ltd., 270 Bath Road, Slough, Berkshire, SL1 4DX, UK.

この装置は、情報処理装置等電波障害自主規制協議会（VCCI）の基準に基づくクラスB情報技術装置です。この装置は、家庭環境で使用することを目的としていますが、この装置がラジオやテレビジョン受信機に近接して使用されると、受信障害を引き起こすことがあります。
取扱説明書に従って正しい取り扱いをして下さい。

Supplying Power

"This product is intended to be supplied by a Listed Direct Plug-In Power Unit marked "Class 2" or LPS and rated 48 V dc, 400 mA." or "May be supplied by a Listed ITE Power over Ethernet (PoE) source that is not routed or exposed to the outside the building."

WARNING Electrical Safety

To avoid electric shock, do not connect safety extra low voltage (SELV) circuits to teleconference station network (TNV) circuits. LAN ports contain SELV circuit, and WAN ports contain TNV circuits. Some LAN and WAN ports both use RJ-45 connectors. Use caution when connecting cables.

This product is rated 48Vdc, 0.375A. When used with the optional external power supply, the power supply shall be a Listed power supply with a LPS output, rated 48V, min. 0.375A.

Russian Compliance

Ministry of Information Technologies & Communication of the Russian Federation - Declaration of Conformity. DoC #СПД-1831. Expiry 20/02/2011.

Safety and Compliance (continued)**New Zealand Telepermit****Polycom SoundPoint IP560 VoIP Telephone PTC 220/08/009****PTC General Warning**

1. The grant of a Telepermit for any item of terminal equipment indicates only that Telecom has accepted that the item complies with minimum conditions for connection to its network. It indicates no endorsement of the product by Telecom, nor does it provide any sort of warranty. Above all, it provides no assurance that any item will work correctly in all respects with another item of Telepermitted equipment of a different make or model, nor does it imply that any product is compatible with all of Telecom's network services.

Echo Cancellation

2. Echo cancellers are not normally required in the Telecom PSTN because geographic delays are acceptable where CPE return loss is maintained within Telepermit limits. However, those private networks making use of Voice over IP technology are required to provide echo cancellation for all voice calls. The combined effect of audio / VoIP conversion delay and IP routing delay can cause an echo cancellation time of 64 mS to be required.

PTC220 Paragraph 8.3.1 Digital Telephone Loudness Rating

3. This Polycom SoundPoint IP560 VoIP Telephone was made to comply with PTC220 paragraph 8.2.1 by installing a New Zealand specific version of software known as Rev 2.2.2.0084. All samples of this telephone connected to the Telecom network must have this software version installed to be fully compliant with this Telepermit.

Index

Symbols

key, page down shortcut 1-13

* key, page up shortcut 1-13

A

AC power 1-4

answering calls 3-4, 3-5

assembling your phone 1-3

assigning speed dial keys 3-22

B

backlight intensity 2-4

base, attaching 1-5

block buddies 4-7

buddy lists 4-5

buddy status 4-8

C

call lists

missed calls 2-10

placed calls 2-10

received calls 2-10

types of 2-10

calls

ending 3-7

on hold 3-8

conference calls

adding parties 3-13, 3-14

ending 3-16

holding parties 3-14

managing 3-12

muting parties 3-13

removing parties 3-14

setting up 3-10

splitting 3-16

contact directory 2-11

contact lists. *See* buddy lists

corporate directory 2-14, 2-18

customizing your phone 2-1

D

display contrast 2-3

Do Not Disturb 3-21

down arrow key, Missed Calls shortcut 2-11

E

electronic hookswitch 2-6

ending calls 3-7

F

features

advanced 4-1

basic 3-1

list of 1-8

SoundPoint 1-8

forwarding calls 3-18

G

getting started with your phone 1-1

graphic display backgrounds 2-9

H

handset

answering a call 3-5

connecting 1-5

illustration 1-2

placing a call 3-3

hands-free mode

answering a call 3-5

disabled 3-3

placing a call 3-3

headset

answering a call 3-6

connecting 1-5

electronic hookswitch 2-6

memory mode 2-6

placing a call 3-4

headset memory mode 2-6

holding calls 3-8

I

instant messaging 4-3

L

language support 2-8

left arrow key, Received Calls shortcut 2-11

M

managing buddies 4-6

Microsoft Office Live Communications
Server 2005 4-5, 4-7

missed call lists 2-10

multiple call appearances 4-1

multiple calls, hold 3-9

multiple keys per line 2-22

multiple lines

call forwarding 3-19

Do Not Disturb 3-22

ring type 2-7

support for 2-21

text messaging 4-4

Voice Mail 3-25

muting microphone 2-10

MyStat 4-6

N

navigation key usage 1-13

P

parts list 1-2

placed call lists 2-10

placing calls 3-2

PoE. *See* Power over Ethernet

power adapter, connecting 1-4

Power over Ethernet (PoE) 1-4

presence 4-5

R

received call lists 2-10

redialing numbers 3-8

restarting phone 4-8

right arrow key, Placed Calls shortcut 2-11

ring type 2-7

RJ-9 1-5

S

setting up conferences 3-9

shared lines 2-23

silent ring, answering calls 3-5

SoundPoint IP 560

adjusting backlight intensity 2-4

adjusting display contrast 2-3

adjusting volume 2-10

advanced features 4-1

answering calls 3-4, 3-5

assembling 1-3

assigning speed dial keys 3-22

attaching base 1-5

basic features 3-1

buddy lists 4-5

call lists, types of 2-10

calls, on hold 3-8

contact directory 2-11

customizing 2-1

Do Not Disturb 3-21

electronic hookswitch 2-6

ending calls 3-7

ending conferences 3-16

features, list of 1-8

figure, features 1-8

first time use 1-12

forwarding calls 3-18

getting started 1-1

handset 1-5

headset 1-5

headset memory mode 2-6

illustration 1-2

instant messaging 4-3

language support 2-8

managing conferences 3-12

multiple call appearances 4-1

multiple keys per line 2-22

muting microphone 2-10

navigation key usage 1-13

parts list 1-2

placing calls 3-2

presence 4-5

redialing numbers 3-8

restarting phone 4-8

ring type 2-7

setting time and date 2-2

setting up conferences 3-9, 3-10

shared lines 2-23

splitting conferences 3-16

text messaging 4-3

transferring calls 3-16

troubleshooting 5-1

using multiple lines 2-21

voice mail 3-24

speakerphone. *See* hands-free mode

speed dialing 3-22

T

text messaging 4-3

time and date 2-2

transferring calls 3-16

troubleshooting

- audio problems 5-8

- calling problems 5-5

- controls problems 5-3

- diagnostics 5-8

- display problems 5-7

- power and startup problems 5-2

- screen and system problems 5-4

U

up arrow key, Speed Dial Index shortcut 3-22

using SIP URL for calling 3-3

V

voice mail 3-24

volume 2-10

W

watch buddies 4-7

