

# Panasonic®

## Operating Instructions

### SIP Phone

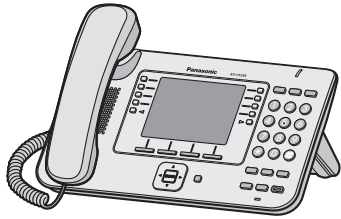

<KX-UT248>

Model No.

**KX-UT113/KX-UT123**  
**KX-UT133/KX-UT136**  
**KX-UT248**

Thank you for purchasing this Panasonic product.

Please read this manual carefully before using this product and save this manual for future use.

**KX-UT113/KX-UT123/KX-UT133/KX-UT136/KX-UT248: Software File Version 01.250 or later**

In this manual, the suffix of each model number (e.g., KX-UT113**NE**) is omitted unless necessary.

# Introduction

## Feature Highlights

### Easy Operation

You can easily access features using the Navigator key, fixed buttons, and soft buttons. Also, the Message/Ringer lamp will inform you when you have an incoming call or a message waiting.

### High-quality Voice Communication

This unit supports the standard SIP protocol and the G.722 codec, enabling reliable and high-quality voice communication.

### ECO Mode

Enabling ECO mode allows you to use this unit while reducing the amount of electricity consumed (Page 45).

### Compatible with Electric Hook Switch (EHS) Headsets (KX-UT133/KX-UT136/KX-UT248 only)

The KX-UT133/KX-UT136/KX-UT248 supports EHS headsets (Page 68).

### Compatible with Bluetooth® Wireless Headsets (KX-UT248 only)

The KX-UT248 supports Bluetooth wireless headsets (Page 68).

## Outline

This manual describes information about the installation and operation of the unit.

## Related Documentation

### Getting Started

Briefly describes basic information about the installation of the unit.

### Administrator Guide

Describes information about the programming and maintenance of the unit.

Manuals and supporting information are provided on the Panasonic Web site at:  
<http://panasonic.net/pcc/support/sipphone>

### Note

- The contents and design of the software are subject to change without notice.

## Notes for Connecting to a Panasonic PBX

- If KX-UT113/KX-UT123/KX-UT133/KX-UT136 is connected to a Panasonic KX-NS1000 PBX, refer to the documentation of the KX-NS1000 for information about the operation, programming, and maintenance of the unit. For details, consult your dealer.  
However, please refer to this documentation for details about the following features:
  - Phonebook (Page 29, 40)
  - Call Log (Page 30)

## Other Information

### Trademarks

- The Bluetooth® word mark and logos are owned by the Bluetooth SIG, Inc. and any use of such marks by Panasonic Corporation is under licence.
- Plantronics is a trademark or registered trademark of Plantronics, Inc.
- All other trademarks identified herein are the property of their respective owners.

### For Future Reference

Record the information in the space below for future reference.

#### Note

- The serial number and MAC address of this product may be found on the label affixed to the bottom of the unit. You should note the serial number and MAC address of this unit in the space provided and retain this manual as a permanent record of your purchase to aid in identification in the event of theft.

MODEL NO.	_____
SERIAL NO.	_____
MAC ADDRESS	_____
DATE OF PURCHASE	_____
NAME OF DEALER	_____
DEALER'S ADDRESS	_____ _____ _____
DEALER'S TEL. NO.	_____

# Table of Contents

<b>Important Information .....</b>	<b>6</b>
For Your Safety .....	6
Data Security .....	8
Additional Information .....	9
<b>Before Operating the Telephone .....</b>	<b>12</b>
Accessory Information .....	12
Location of Controls .....	13
Screens .....	23
Status Icons .....	24
Soft Buttons and Soft Button Icons .....	25
Basic Operations .....	27
Confirming Your Extension Number .....	27
Going off- and on-hook .....	27
Adjusting the Volume .....	28
<b>Feature Operations .....</b>	<b>29</b>
<b>Making Calls .....</b>	<b>29</b>
Making a Call .....	29
Making a Call from the Phonebook List .....	29
Dialling by Using Call Logs .....	30
Redialling the Last Number You Dialed (Redial, Last Number) .....	30
One-touch Dialling (KX-UT133/KX-UT136/KX-UT248 only) .....	30
<b>Receiving Calls .....</b>	<b>31</b>
Receiving a Call .....	31
Rejecting Calls .....	31
<b>Holding a Call .....</b>	<b>33</b>
<b>Receiving a Second Call (Answering Call Waiting) .....</b>	<b>33</b>
<b>Talking to Two Parties Alternately (Call Splitting) .....</b>	<b>34</b>
<b>Transferring a Call (Call Transfer) .....</b>	<b>34</b>
To Transfer with One Touch (One-touch Transfer) (KX-UT133/KX-UT136/KX-UT248 only) .....	34
<b>Mute .....</b>	<b>35</b>
<b>Conference Call (Local Three-way Conference) .....</b>	<b>36</b>
Making a Conference Call .....	36
Removing a Party from the Conference .....	36
Ending a Conference Call .....	36
<b>Checking Messages .....</b>	<b>37</b>
Checking New Messages .....	37
<b>Checking Missed Calls .....</b>	<b>37</b>
<b>Erasing All Call Logs .....</b>	<b>37</b>
<b>Call Forwarding/Do Not Disturb .....</b>	<b>38</b>
<b>Logging in to or Logging out of a Group (KX-UT133/KX-UT136/KX-UT248 only) .....</b>	<b>38</b>
Logging in to or Logging out of an ACD (Automatic Call Distribution) Group .....	38
To set/cancel Not Ready mode or to leave Wrap Up mode .....	38
<b>Flexible Buttons (KX-UT133/KX-UT136/KX-UT248 only) .....</b>	<b>39</b>
<b>Customising the Telephone .....</b>	<b>40</b>
<b>Phonebook List .....</b>	<b>40</b>
Adding a New Phonebook Entry .....	40
Adding a Phonebook Entry from the Incoming or Missed Call Log .....	40

Editing a Phonebook Entry .....	40
Searching for a Phonebook Entry .....	41
Deleting a Phonebook Entry .....	41
Export/Import Phonebook Entries .....	41
<b>User Settings .....</b>	<b>42</b>
Accessing the Settings .....	42
Available Settings .....	43
Settings Details .....	45
<b>Entering Characters .....</b>	<b>55</b>
<b>Web User Interface Programming .....</b>	<b>63</b>
<b>Installation and Setup .....</b>	<b>64</b>
Attaching/Removing the Stand .....	64
Connections .....	67
Wall Mounting .....	71
Hooking the Handset .....	76
Using a Headset .....	78
Setting Up the Unit .....	79
Maintaining the Unit .....	80
Initialising the Unit .....	80
Restarting the Unit .....	80
Cleaning the Unit .....	80
<b>Appendix .....</b>	<b>81</b>
<b>Specifications .....</b>	<b>81</b>
<b>Troubleshooting .....</b>	<b>83</b>
Common Issues and Solutions .....	83
Error Messages .....	87
<b>Revision History .....</b>	<b>88</b>
KX-UT113/KX-UT123/KX-UT133/KX-UT136 Software File Version 01.025 .....	88
KX-UT113/KX-UT123/KX-UT133/KX-UT136 Software File Version 01.080 .....	89
KX-UT113/KX-UT123/KX-UT133/KX-UT136/KX-UT248 Software File Version 01.160 .....	90
KX-UT113/KX-UT123/KX-UT133/KX-UT136/KX-UT248 Software File Version 01.250 .....	90
<b>Open Source Software .....</b>	<b>91</b>
<b>Index.....</b>	<b>95</b>

# Important Information

## For Your Safety

To reduce the risk of injury, loss of life, electric shock, fire, malfunction, and damage to equipment or property, always observe the following safety precautions.

### Explanation of symbols

The following symbols are used to classify and describe the level of hazard and injury caused when the denotation is disregarded and improper use is performed.



## WARNING

Denotes a potential hazard that could result in serious injury or death.



## CAUTION

Denotes a hazard that could result in minor injury or damage to the unit or other equipment.

The following symbols are used to classify and describe the type of instructions to be observed.



This symbol is used to alert users to a specific operating procedure that must not be performed.



This symbol is used to alert users to a specific operating procedure that must be followed in order to operate the unit safely.



## WARNING

### General Safety



Do not disassemble this unit. Dangerous electrical shock could result. The unit must only be disassembled and repaired by qualified service technicians.



Never attempt to insert wires, pins, etc. into the vents or other holes of this unit.



To prevent possible fire or electric shock, do not expose this unit to rain or moisture.



Do not splash water on the AC adaptor and/or the AC adaptor cord, nor get them wet. Doing so can result in fire, electric shock, or injury. If they do get wet, immediately disconnect the AC adaptor and/or the AC adaptor cord, and contact an authorised service centre.



Do not connect or disconnect the AC adaptor and/or the AC adaptor cord with wet hands.



Do not touch the AC adaptor for extended periods of time. Doing so can lead to low-degree burns.



Unplug this unit from the AC outlet and have the unit serviced by qualified service personnel in the following cases:



- A.** When the power supply cord or plug is damaged or frayed.
- B.** If liquid has been spilled on the unit.
- C.** If the unit has been exposed to rain or water.
- D.** If the unit does not work normally by following the manual. Adjust only controls covered by the manual. Improper adjustment may require repair by an authorised service centre.
- E.** If the unit has been dropped, or damaged.
- F.** If the unit's performance deteriorates.







If damage to the unit exposes any internal parts, immediately disconnect the cable or cord. If the power is supplied from the network to the SIP Phone [Power-over-Ethernet], disconnect the Ethernet cables. Otherwise, disconnect the AC adaptor cord. Then return this unit to an authorised service centre.





This handset earpiece is magnetised and may retain small ferrous objects.

-  The use of excessive sound volume through earphones, headphones, or headsets may cause hearing loss.
-  Disconnect this unit from power outlet/the Ethernet cables if it emits smoke, an abnormal smell, or makes unusual noise. These conditions can cause fire or electric shock. Confirm that smoke has stopped and contact an authorised service centre.



### Installation



-  Do not make power connections that exceed the ratings for the AC outlet or power equipment. If the power rating of a surge protector, etc. is exceeded, it can cause a fire due to heat buildup.
-  Do not bundle up the AC adaptor cord. The cord may become damaged, which can lead to a fire, electric shock, or electric short.
-  The unit should only be connected to a power supply of the type as shown on the label on the unit.
-  Completely insert the AC adaptor into the AC outlet. Failure to do so may cause electric shock and/or excessive heat resulting in a fire.

### Medical (KX-UT248 only)





-  Do not use the product in health care facilities if any regulations posted in the area instruct you not to do so. Hospitals or health care facilities may be using equipment that could be sensitive to external RF energy.
-  Consult the manufacturer of any personal medical devices, such as pacemakers or hearing aids, to determine if they are adequately shielded from external RF (radio frequency) energy (the product operates in the frequency range of 2.402 GHz to 2.480 GHz and the power output is 2.5 mW [max.]).

### Placement

-  Care should be taken so that objects do not fall onto, and liquids are not spilled into, the unit. Do not subject this unit to excessive smoke, dust, moisture, mechanical vibration, shock, or direct sunlight.
-  Do not place heavy objects on top of this unit.





-  Place this unit on a flat surface.
-  Allow 10 cm clearance around the unit for proper ventilation.

### Wall Mounting

-  Do not mount the unit in a manner other than that described in this manual.
-  Make sure that the wall that the unit will be attached to is strong enough to support the unit. If not, it is necessary for the wall to be reinforced. For information about the weight of the unit, see "Specifications (Page 81)".
-  Only use the optional wall mount kit with the unit. The wall mount kit includes the necessary screws, washers, and wall mounting adaptor.
-  When driving the screws into the wall, be careful to avoid touching any metal laths, wire laths or metal plates in the wall.
-  When this unit is no longer in use, make sure to detach it from the wall.



## CAUTION

-  Keep the unit away from heating appliances and devices that generate electrical noise, such as fluorescent lamps, motors and televisions. These noise sources can interfere with the performance of the unit. It also should not be placed in rooms where the temperature is less than 0 °C or greater than 40 °C.
-  Wipe the unit with a soft cloth. Do not clean the unit with abrasive powders or with chemical agents such as benzine or thinner.
-  The handset hook poses a choking hazard. Keep the handset hook out of reach of children.
-  When left unused for a long period of time, disconnect the unit from the AC outlet. When the unit receives power from a PoE power supply, disconnect the Ethernet cables.
-  When the unit is mounted on a wall, make sure the cables are securely fastened to the wall.

### Notice

- If the unit does not operate properly, disconnect the AC adaptor cord and Ethernet cables and then connect again.
- If you are having problems making calls, disconnect the Ethernet cables and connect a known working SIP Phone. If the known working SIP Phone operates properly, have the defective SIP Phone repaired by an authorised service centre. If the known working SIP Phone does not operate properly, check the SIP server and the Ethernet cables.
- Under power failure conditions, the SIP Phone may not operate. Please ensure that a separate telephone, not dependent on local power, is available for use in remote sites in case of emergency.
- For information regarding network setup of the SIP Phone such as IP addresses, please see "Network Settings (Page 49)".
- If an error message is shown on your display, consult your phone system dealer or the network administrator.
- Use only the correct Panasonic handset.

## Data Security

We recommend observing the security precautions described in this section, in order to prevent the following:

- loss, disclosure, falsification, or theft of user information
- unauthorised use of the unit
- interference or suspension of use caused by an unauthorised party

**We cannot be responsible for damages resulting from the misuse of this product.**

User information is defined as the following:

- Phonebook names, phone numbers, and IP addresses
- Forwarding destination numbers
- Numbers stored in One-touch Dialling buttons
- Passwords used to log in to the Web user interface
- Call logs

### Preventing Data Loss

- Keep a copy of all important data (such as the phonebook list) in case the machine malfunctions and data cannot be recovered.
- There is a risk that data stored or saved on the unit may be changed or deleted when, for instance, the unit is being repaired. To protect important data from unexpected damage, see Data Security (Page 8).

### Preventing Data Disclosure

- Store backups in a secure location.
- Do not store sensitive personal information in the unit.
- Personal information (such as the phonebook list and call log) can be registered and/or saved on this unit. To prevent data leakage or unexpected damages, make a record of necessary user information, etc., and initialise the unit to return it to its factory settings in the following cases.
  - When passing on or disposing of the unit
  - When lending the unit
  - When having the unit repaired
- Make sure the unit is serviced by only a certified technician.
- When user information is sent from the unit to a PC or other external device, the confidentiality of that information becomes the responsibility of the customer. Before disposing of the PC or other



external device, ensure that data cannot be retrieved from it by formatting the hard disk and/or rendering it physically unusable.

## Preventing Data Disclosure Over the Network

- To ensure the security of private conversations, only connect the unit to a secure network.
- To prevent unauthorised access, only connect the unit to a network that is properly managed.
- Make sure all personal computers that are connected to the unit employ up-to-date security measures.

## Security Information

- Security settings, such as passwords, cannot be undone at Panasonic service centres. Take measures to prevent passwords from being lost or forgotten.
- If a password is forgotten, initialise the unit and configure the settings again. For details, consult your administrator or dealer.
- For best security, set passwords that cannot be guessed easily, and change passwords periodically.
- If using SSL authentication, an NTP server must also be specified. Furthermore, if SSL authentication is performed without specifying an NTP server, authentication will be unconditionally validated without confirming the validity of the SSL certificate.

## Additional Information

### Important Safety Instructions

When using this unit, basic safety precautions should always be followed to reduce the risk of fire, electric shock and injury to persons, including the following:

1. Do not use the unit near water, for example, near a bathtub, washbowl, kitchen sink, or laundry tub, in a wet basement, or near a swimming pool.
2. Avoid using a telephone (other than a cordless type) during an electrical storm. There may be a remote risk of electric shock from lightning.
3. Do not use the telephone to report a gas leak in the vicinity of the leak.

### SAVE THESE INSTRUCTIONS

### For Users in Australia and the United Kingdom

- This unit is capable of being used in conjunction with hearing aids fitted with inductive coil pick-ups. The handset should be held as for normal conversation. For operation, the hearing aid should be set to its "T" position or as directed in the operating instructions for the hearing aid. 
- This unit is designed to aid the visually handicapped to locate dial keys and buttons.

### For Users in the United Kingdom

- This unit is designed to be installed under controlled conditions of ambient temperature and a relative humidity.
- Avoid installing the unit in damp or humid environments, such as bathrooms or swimming pools.
- 999 and 112 can be dialled on the product after accessing the outside line for the purpose of making outgoing calls to the BT emergency (999) and (112) services.  
The method for accessing an outside line differs depending on the SIP server. For details, confirm the features of the SIP server.

## For Users in New Zealand

- This equipment shall not be set to make automatic calls to the Telecom '111' Emergency Service.

### PTC General Warning

- The grant of a Telepermit for any item of terminal equipment indicates only that Telecom has accepted that the item complies with minimum conditions for connection to its network. It indicates no endorsement of the product by Telecom, nor does it provide any sort of warranty. Above all, it provides no assurance that any item will work correctly in all respects with another item of Telepermitted equipment of a different make or model, nor does it imply that any product is compatible with all of Telecom's network services.

### The Use of IP Networks through the PSTN

- Internet Protocol (IP) by its nature introduces delay into speech signals as each data packet is formulated and addressed. Telecom Access Standards recommends that suppliers, designers and installers using this technology for calls to or from the PSTN refer to ITU E Model requirements in the design of their networks. The overall aim is to minimise delay, distortion and other transmission impairments, particularly for those calls involving cellular and international networks, which already suffer extensive delay.

### Echo cancellation

- Echo cancellers are not normally required in the Telecom PSTN because geographic delays are acceptable where CPE return loss is maintained within Telepermit limits. However, those private networks making use of Voice over IP technology are required to provide echo cancellation for all voice calls. The combined effect of audio / VoIP conversion delay and IP routing delay can cause the echo cancellation time of  $\geq 64$  mS to be required.

## For Users in the European Union



KX-UT113/KX-UT123  
KX-UT133/KX-UT136



KX-UT248

For information of Compliance with EU relevant Regulatory Directives,  
Contact to Authorised Representative:  
Panasonic Testing Centre  
Panasonic Marketing Europe GmbH  
Winsbergring 15, 22525 Hamburg, Germany

## Information for Users on Collection and Disposal of Old Equipment and used Batteries

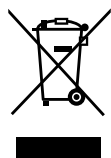

These symbols on the products, packaging, and/or accompanying documents mean that used electrical and electronic products and batteries should not be mixed with general household waste.

For proper treatment, recovery and recycling of old products and used batteries, please take them to applicable collection points, in accordance with your national legislation and the Directives 2002/96/EC and 2006/66/EC.

By disposing of these products and batteries correctly, you will help to save valuable resources and prevent any potential negative effects on human health and the environment which could otherwise arise from inappropriate waste handling.

For more information about collection and recycling of old products and batteries, please contact your local municipality, your waste disposal service or the point of sale where you purchased the items.

Penalties may be applicable for incorrect disposal of this waste, in accordance with national legislation.

### For business users in the European Union

If you wish to discard electrical and electronic equipment, please contact your dealer or supplier for further information.



### Information on disposal in other countries outside the European Union

These symbols are only valid in the European Union. If you wish to discard these items, please contact your local authorities or dealer and ask for the correct method of disposal.



### Note for the battery symbol (bottom two symbol examples):

This symbol might be used in combination with a chemical symbol. In this case it complies with the requirement set by the Directive for the chemical involved.

# Before Operating the Telephone

## Accessory Information

### Included Accessories

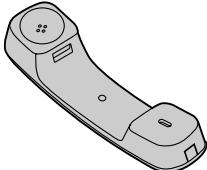
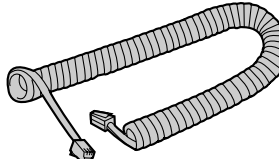
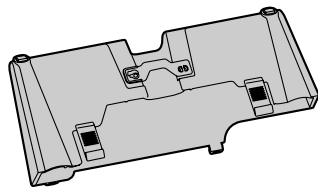
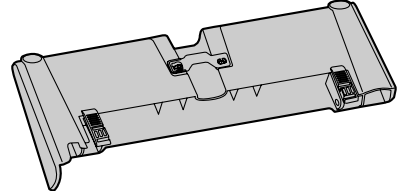
<b>Handset (1)</b>	<b>Handset Cord (1)</b>
	
<b>Stand (1)</b>	
<b>For KX-UT113/KX-UT123:</b>	<b>For KX-UT133/KX-UT136/KX-UT248:</b>
	

**Note**

- The illustrations may differ from the appearance of the actual product.

### Optional Accessories

AC Adaptor <sup>*1</sup>	<ul style="list-style-type: none"> <li>• For KX-UT113X/KX-UT123X/KX-UT133X/KX-UT136X/KX-UT248X: KX-A239AL (PQLV206AL)/KX-A239BX (PQLV206CE)/KX-A239UK (PQLV206E)/KX-A239X (PQLV206)/KX-A239EJ (PQLV206E)/KX-A420BR (PSLP1662)</li> <li>• For KX-UT113NE/KX-UT123NE/KX-UT133NE/KX-UT136NE/KX-UT248NE: KX-A239CE (PQLV206CE)</li> <li>• For KX-UT113RU/KX-UT123RU/KX-UT133RU/KX-UT136RU/KX-UT248RU: KX-A239BX (PQLV206CE)</li> </ul>
Wall Mount Kit	<ul style="list-style-type: none"> <li>• For KX-UT113/KX-UT123: KX-A432X</li> <li>• For KX-UT133/KX-UT136/KX-UT248: KX-A433X</li> </ul>

<sup>\*1</sup> To order an optional AC adaptor, please order using the "KX-A239xx/KX-A420BR" model number (not "PQLV206xx/PSLP1662"). For users in Argentina, power can only be supplied by PoE.

# Location of Controls

## Front View

For KX-UT113X/KX-UT123X:

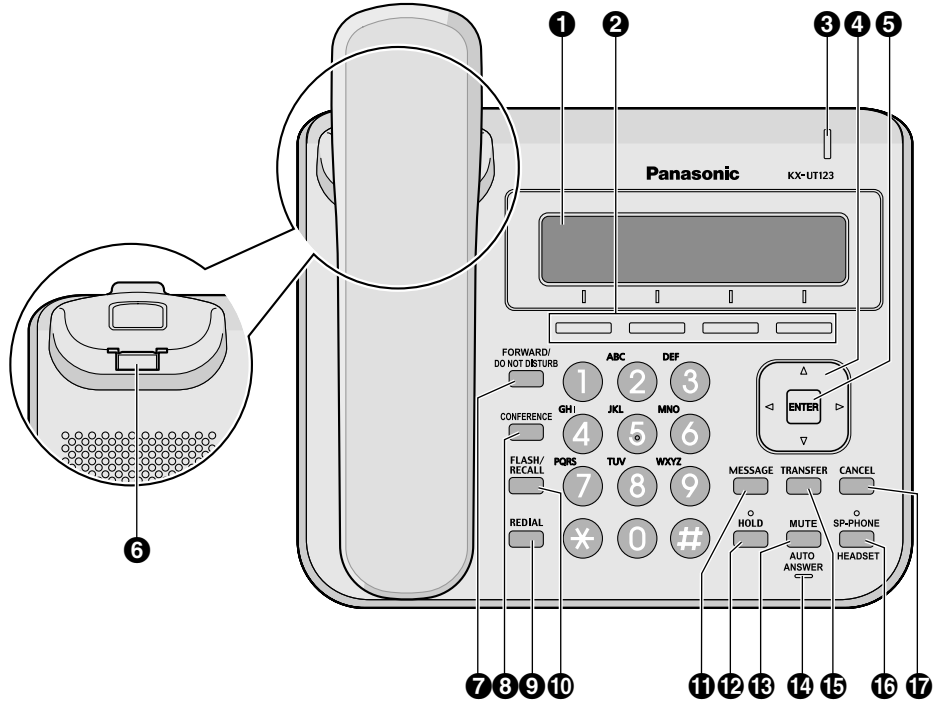

For KX-UT113NE/KX-UT123NE:

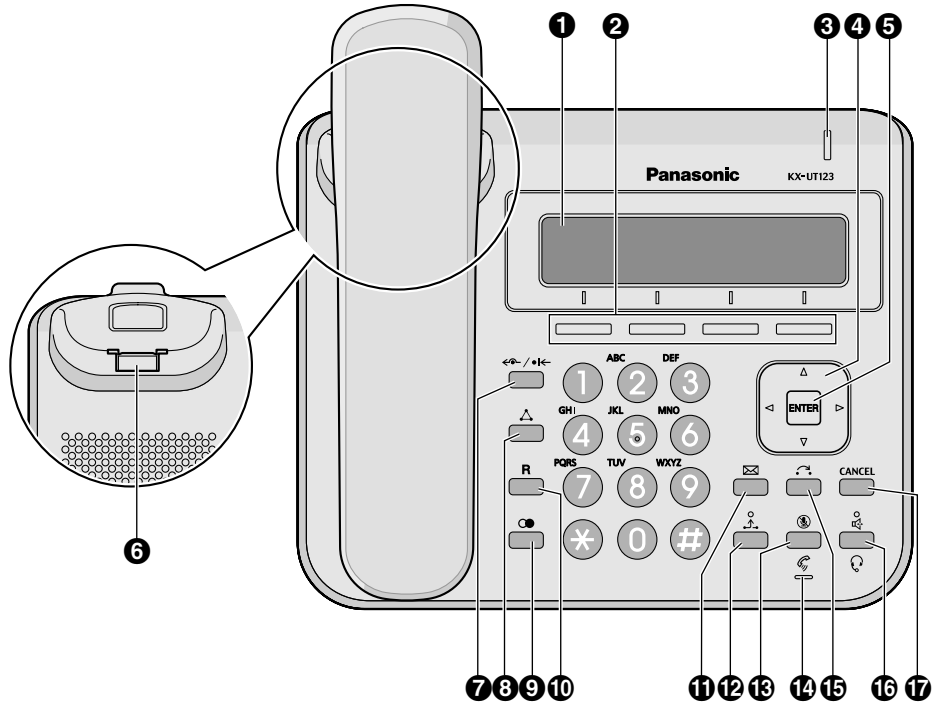

For KX-UT113RU/KX-UT123RU:

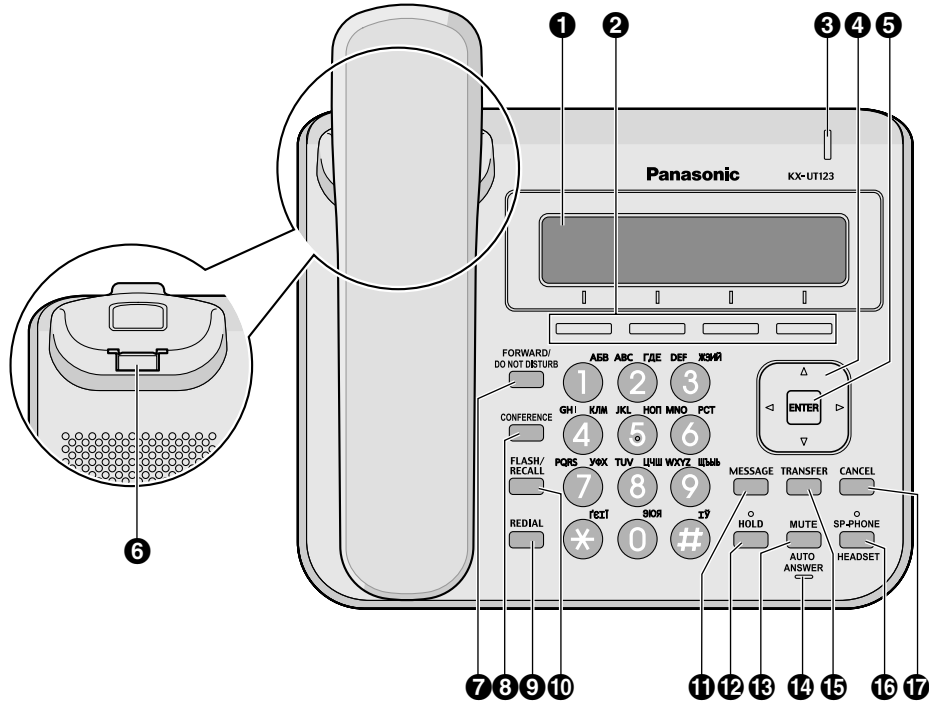

For KX-UT133X:

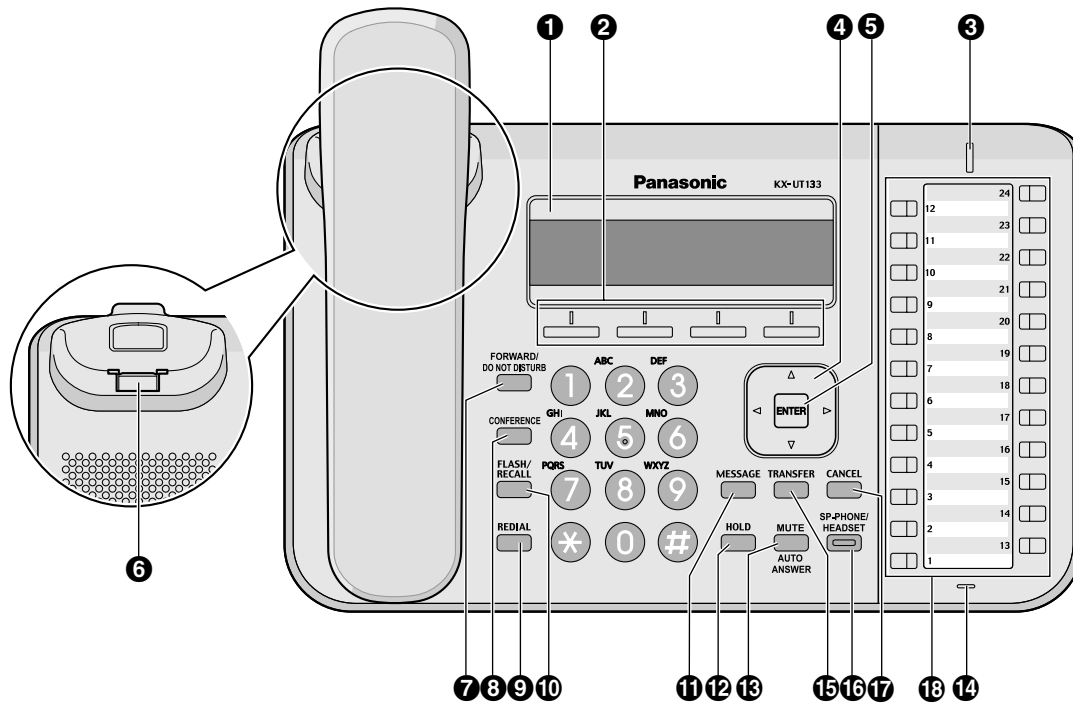

For KX-UT133NE:

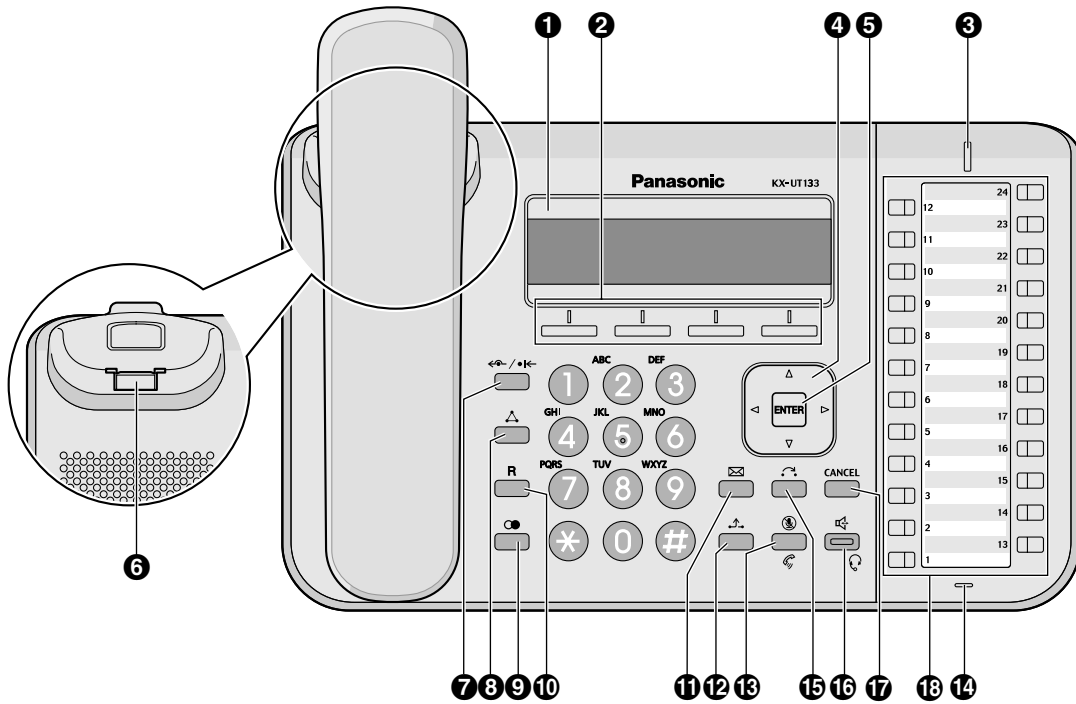

For KX-UT133RU:

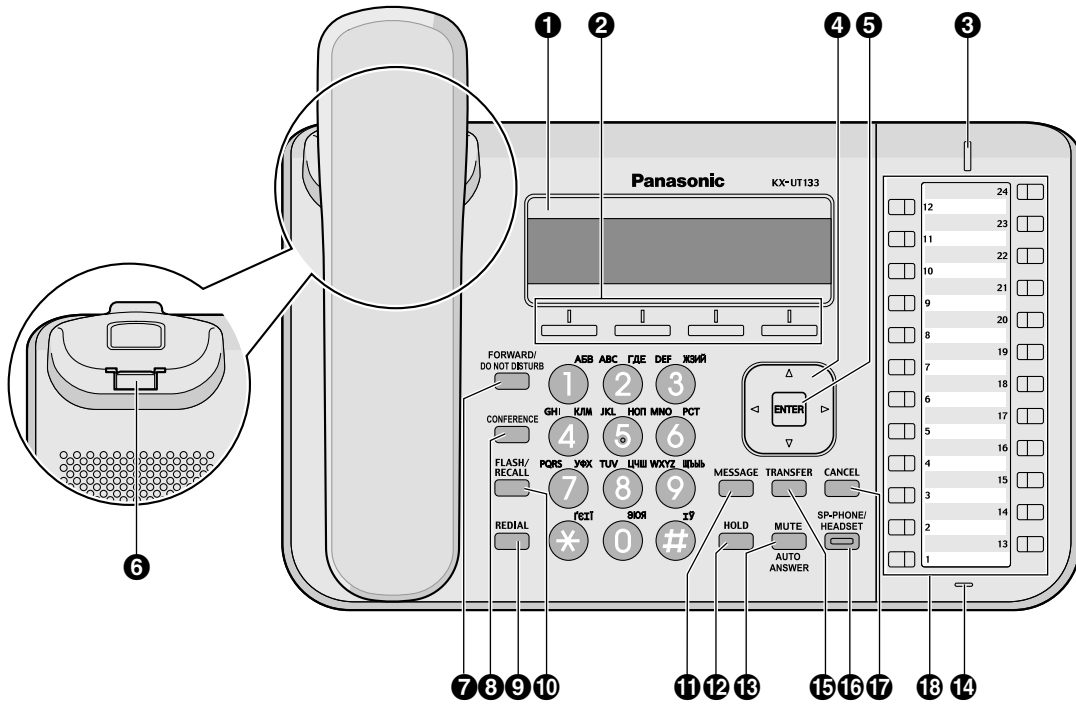

For KX-UT136X:

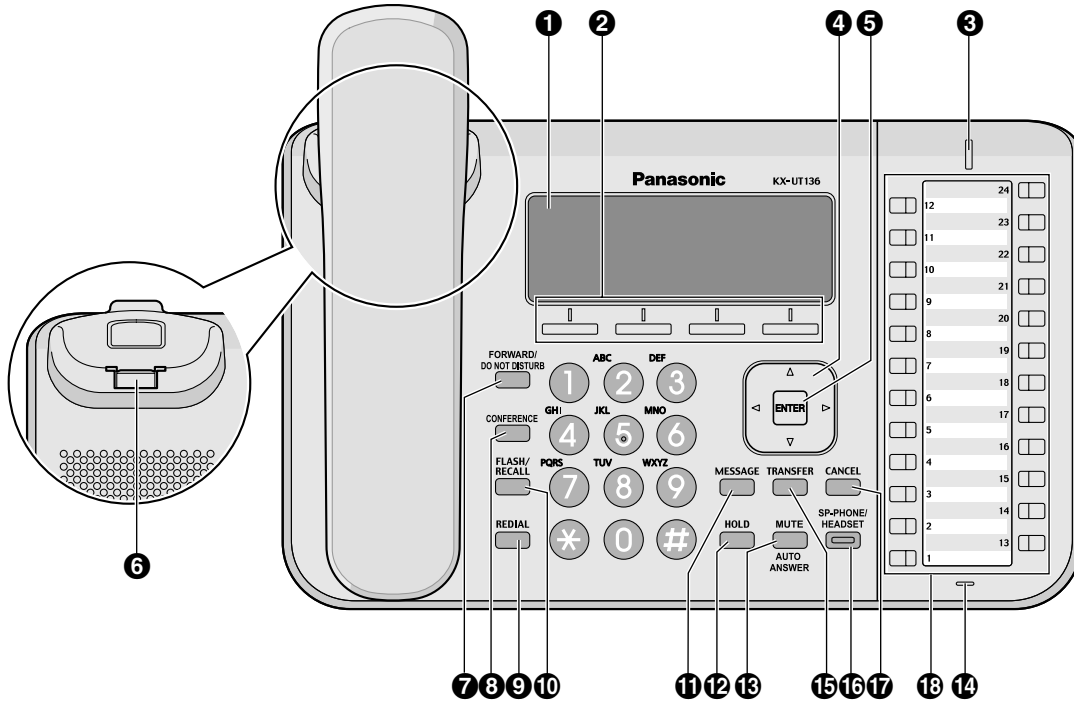

For KX-UT136NE:

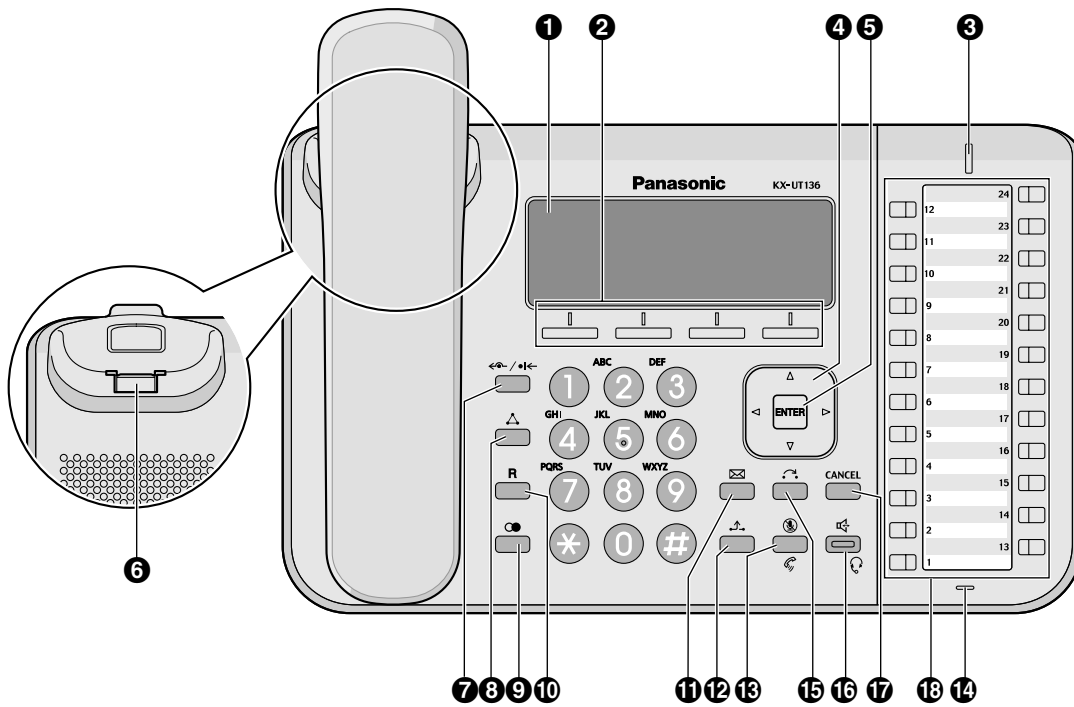



For KX-UT136RU:

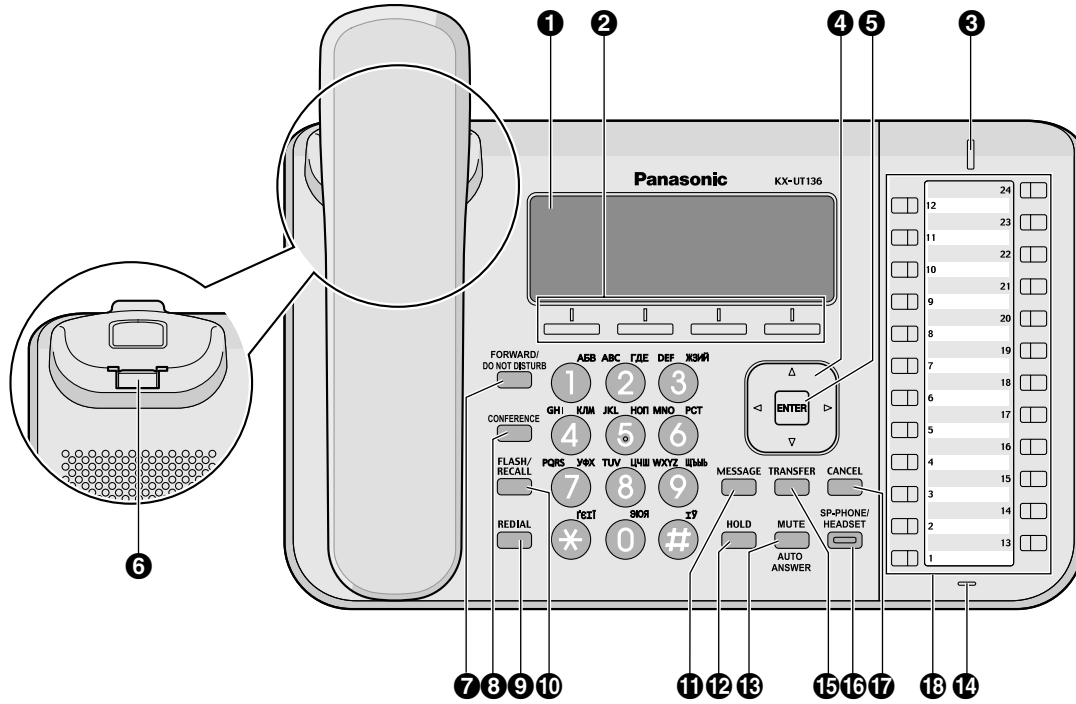

For KX-UT248X:

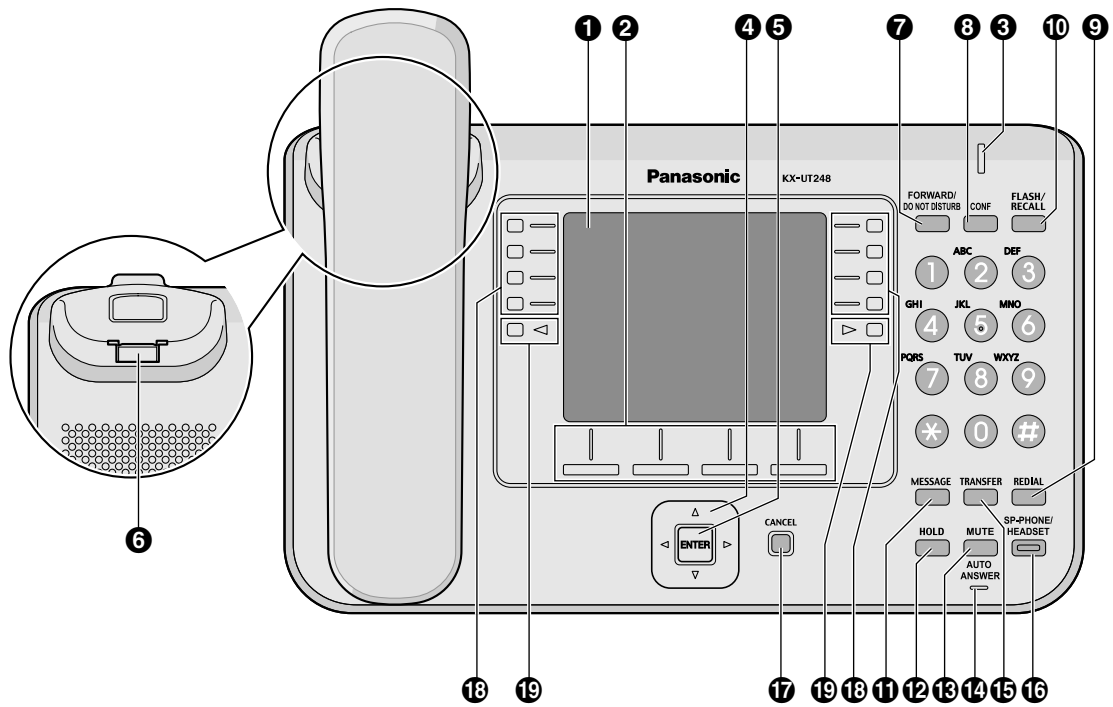

For KX-UT248NE:

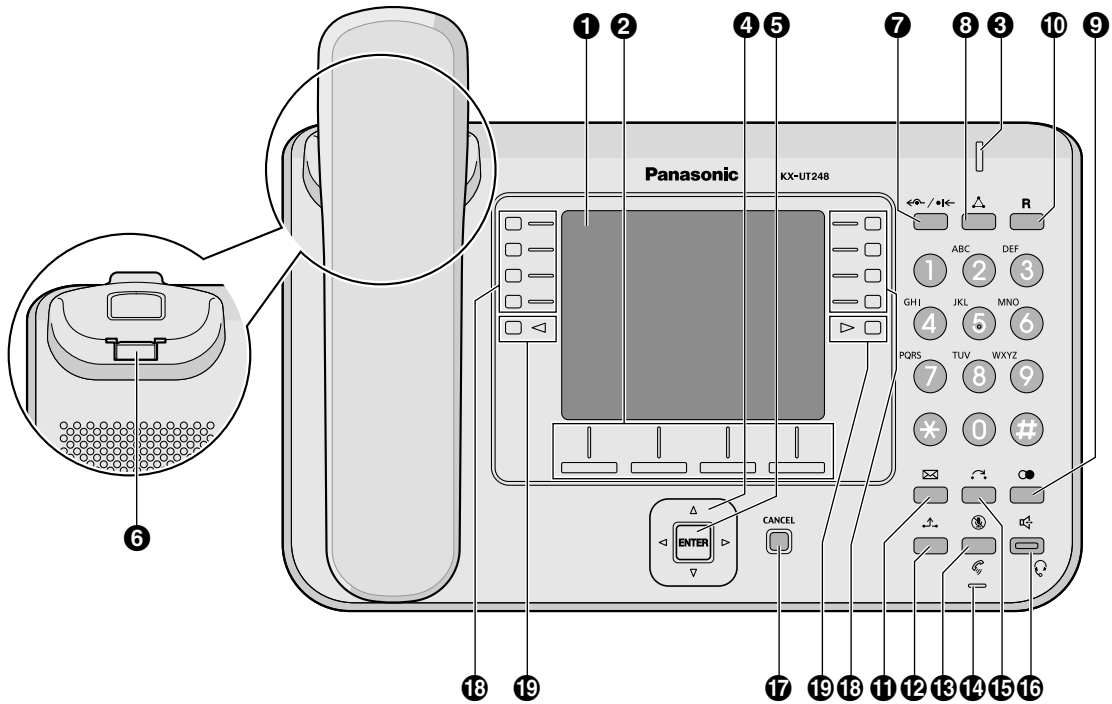

For KX-UT248RU:

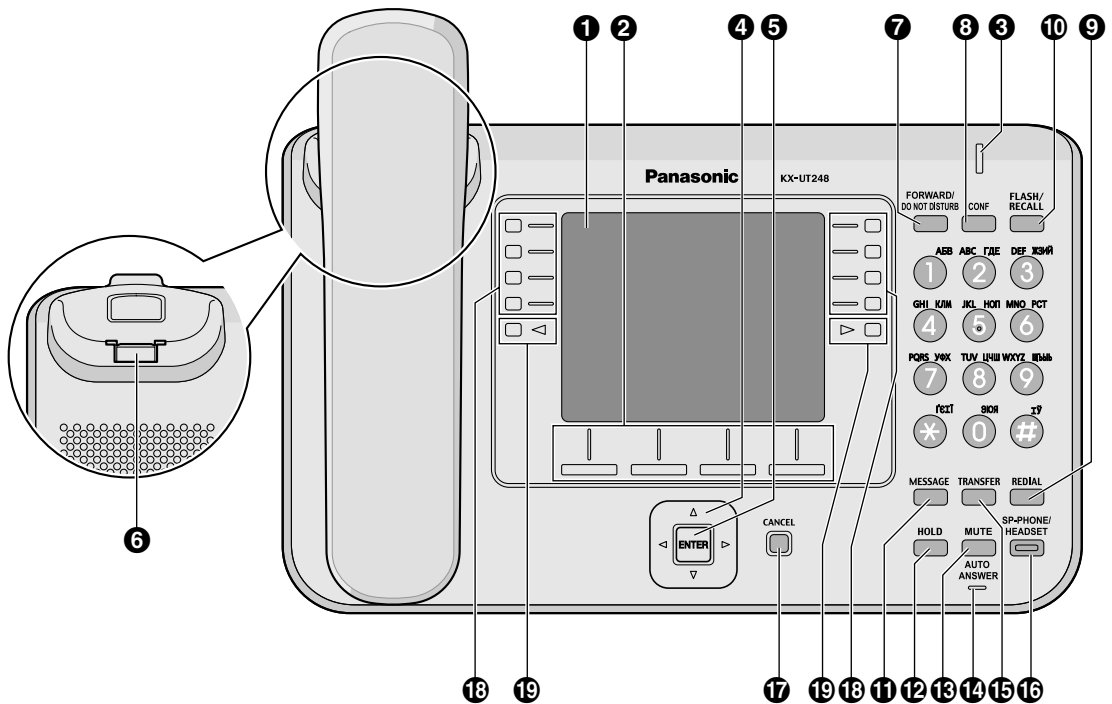

**1 LCD (Liquid Crystal Display)**

KX-UT113 is equipped with a 3-Line LCD.

KX-UT123/KX-UT133 is equipped with a 3-Line LCD and LCD backlight.

KX-UT136 is equipped with a 6-Line LCD and LCD backlight.

KX-UT248 is equipped with a 4.4-inch LCD and LCD backlight.

**2 Soft Buttons (S1 to S4)**

S1 to S4 (located below the display) are used to select the item displayed on the bottom line of the display.

**3 Message/Ringer Lamp<sup>\*1</sup>**

When you receive a call or Hold Recall, the lamp flashes green.

When someone has left you a message, the lamp stays on red.

<sup>\*1</sup> If KX-UT113/KX-UT123/KX-UT133/KX-UT136 is connected to a KX-NS1000 PBX, the Message/Ringer Lamp shows the current status as follows:

- Green flashing: You are receiving an intercom call, or you are receiving a Hold Recall or Transfer Recall from an extension.
- Red flashing: You are receiving an outside call, or you are receiving a Hold Recall or Transfer Recall from an outside line.
- Red on: You have a message.

**4 Navigator Key**

Used to adjust the volume or select desired items.

**5 ENTER**

Used to assign the selected item.

**6 Handset Hook**

Keeps the handset stable when the unit is mounted on a wall. For details, see "To Lock the Handset Hook when the Unit is Wall Mounted (Page 76)".

**7 FORWARD/DO NOT DISTURB/  / **

Used to set Call Forwarding or Do Not Disturb on your extension.

**8 CONF (Conference)/CONFERENCE/ **

Used to establish a local three-way conference.

**9 REDIAL/ **

Used to redial the last dialed number.

**10 FLASH/RECALL/R**

Used to disconnect the current call and make another call without hanging up.

**11 MESSAGE/ **

Used to access your voice mailbox.

**12 HOLD/ **

Used to put a call on hold.

When a call is on hold, the Hold lamp (KX-UT113/KX-UT123 only) flashes red.

**13 MUTE/AUTO ANSWER/  / **

Used to receive an incoming call in hands-free mode or mute the microphone/handset during a conversation.

**14 MIC**

Used for hands-free conversation.

**15 TRANSFER/ **

Used to transfer a call to another party.

**16 SP-PHONE (Speakerphone)/HEADSET/  / **

Used for performing hands-free operations. When the SP-PHONE is used, the lamp on the SP-PHONE (KX-UT133/KX-UT136/KX-UT248 only) or the lamp above the SP-PHONE (KX-UT113/KX-UT123 only) turns red. When muted, the lamp flashes red.

**17 CANCEL**

Used to cancel the selected item.

**18 Flexible Buttons/Flexible Button Lamps (KX-UT133/KX-UT136/KX-UT248 only)**

Used to make or receive calls, or perform the feature that has been assigned to the button. The flexible button lamp shows the status of each flexible button. For details, see "Flexible Buttons (KX-UT133/KX-UT136/KX-UT248 only) (Page 39)".

**19 Page Keys (KX-UT248 only)**

Used to switch the page of flexible buttons displayed. There are three pages of eight flexible buttons. For details, see "Display of Assigned Flexible Buttons (KX-UT248 only) (Page 24)".

## Left Side View

For KX-UT113/KX-UT123:

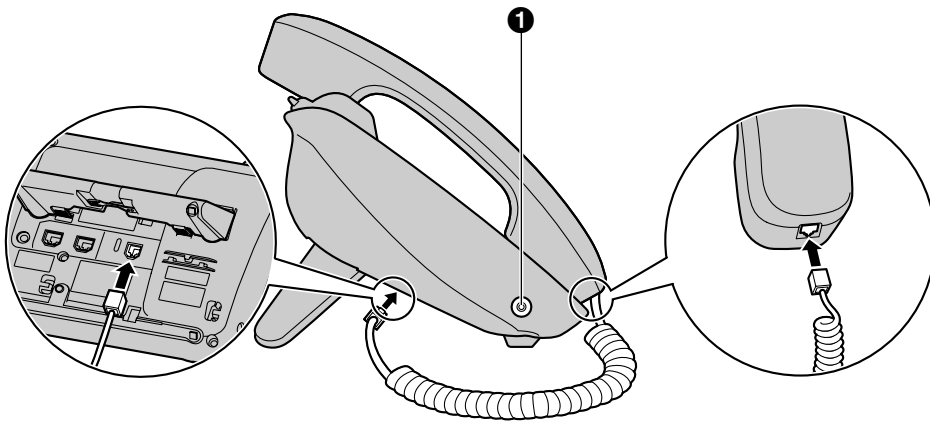

For KX-UT133/KX-UT136/KX-UT248:

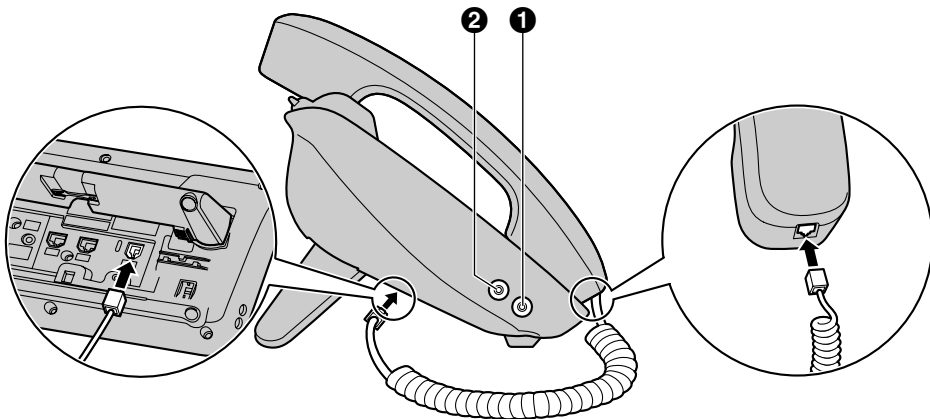

- ❶ Headset Jack
- ❷ EHS Jack (KX-UT133/KX-UT136/KX-UT248 only)

## Bottom View

For KX-UT113:

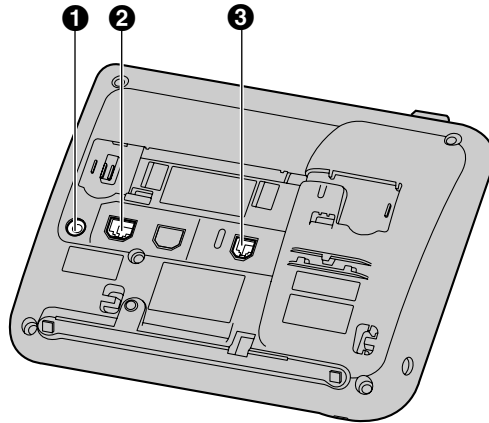

For KX-UT123:

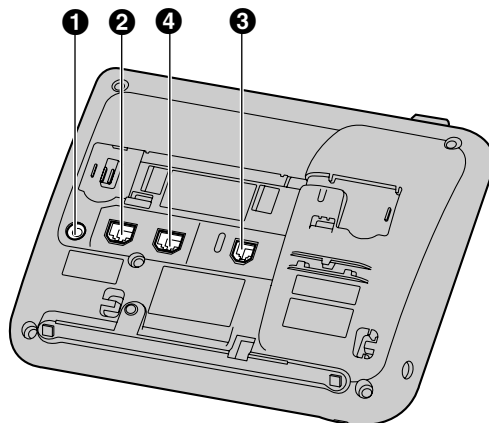

For KX-UT133/KX-UT136/KX-UT248:

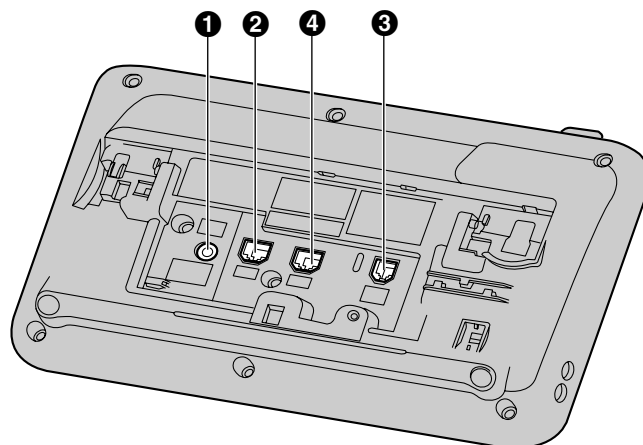

❶ DC Jack

## Before Operating the Telephone

---

- ② LAN Port
- ③ Handset Jack
- ④ PC Port (KX-UT123/KX-UT133/KX-UT136/KX-UT248 only)

## Screens

This section explains the buttons and icons that appear on the display.

**Note**

- The actual appearance of the screen may differ on your unit.

For KX-UT113/KX-UT123/KX-UT133:



For KX-UT136:

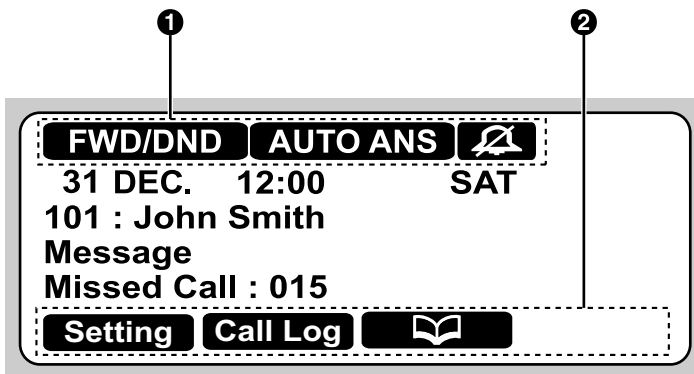

For KX-UT248:

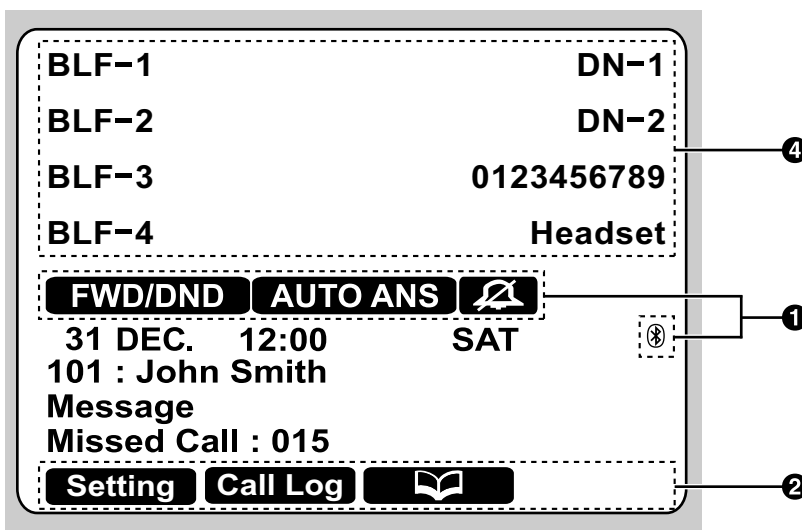

**1 Status Icons**

Indicates the status of various features (Page 24).

**2 Soft Button Icons**

Indicate the functions that will be accessed when the corresponding buttons are pressed. The icons displayed vary according to the state of the unit. (For example, the icons displayed while on a call are different from the icons displayed while storing an entry in the phonebook.)

**3 Scroll Indicator**

Indicates that [▲], [▼], [◀], or [▶] can be pressed to display the previous or next item.









**Note**

- Although the scroll indicator is not shown in the screen sample of the KX-UT136/KX-UT248 above, it does appear on some screens.

**4 Display of Assigned Flexible Buttons (KX-UT248 only)**

Indicates a page of flexible buttons (Page 39). The names assigned to the flexible buttons are displayed on each page (Page 19).

## Status Icons

Icon	Description
	Displayed when Call Forwarding or Do Not Disturb is enabled (Page 38).
	Displayed when Auto Answer is enabled (Page 31).
	Displayed when the ringer is turned off (Page 28).
	Displayed when ECO mode is enabled (Page 45).
	Displayed when registration to the SIP server has been lost. If this icon is displayed, consult your administrator or dealer.
	Displayed next to lines that have new messages when checking new messages (Page 37).
	For KX-UT248 only, displayed when a Bluetooth headset is registered and connected (Page 78).
	For KX-UT248 only, displayed when a Bluetooth headset is registered but not connected (Page 78).







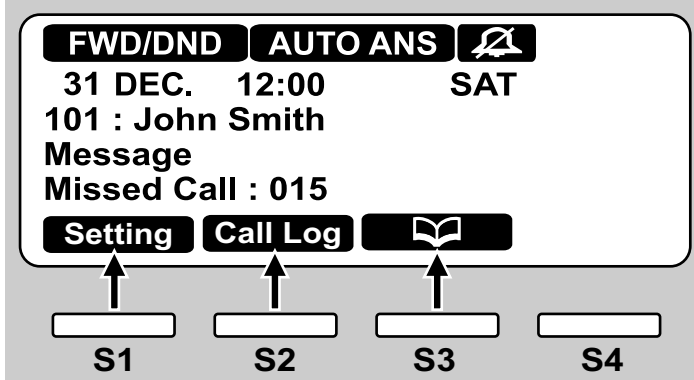









## Soft Buttons and Soft Button Icons

By pressing a soft button (S1 to S4), you can access the function displayed directly above it.



In this manual, soft buttons are referred to by their corresponding icons.

In the example here, "Press ", "Press ", or "Press " would indicate pressing S1, S2, or S3, respectively.

Icon	Description
	Access the user setting menus (Page 42).
	Access the call log (Page 30).
	Access the phonebook (Page 40).
	Access the setup menus (Page 79).
	Erase the number or character above the cursor (Page 29).
	Search for a phonebook entry (Page 29).
	<p>Edit a call log or phonebook entry (Page 30, Page 40).</p> <p>Access the system features of the PBX (System Feature Access).</p> <p><b>Note</b></p> <ul style="list-style-type: none"> <li>You can access the system features only if KX-UT113/KX-UT123/KX-UT133/KX-UT136 is connected to a KX-NS1000 PBX. For details, refer to the documentation of the KX-NS1000.</li> </ul>
	Confirm a transfer operation (Page 34).
	Begin installation of a firmware update (Page 52).
	<p>Save or confirm the information shown on the display.</p> <p><b>Note</b></p> <ul style="list-style-type: none"> <li>You can also use the physical <b>ENTER</b> button to perform the same operation as this soft button.</li> </ul>
	For KX-UT113/KX-UT123 only, if multiple lines are available at your unit, select the line to use to make a call (Page 29).

Icon	Description
<b>Answer</b>	Answer an incoming call (Page 27).
<b>End</b>	Close the incoming call screen and continue pre-dialling (Page 29).
<b>Reject</b>	Reject an incoming call (Page 31).
<b>Xfer-Un</b>	Perform an unscreened (blind) transfer (Page 34).
<b>Add</b>	Add an entry, such as to the call rejection list or the phonebook (Page 32, Page 40).
<b>Delete</b>	Delete the information shown on the display (Page 32, Page 41).
<b>Save</b>	Save the information shown on the display (Page 32, Page 40).
<b>Call</b>	Make a call (Page 29).
<b>Edit</b>	Edit the information shown on the display (Page 30, Page 32, Page 40).
<b>Default</b>	Assign the preferred number to dial among multiple registered phone numbers in the same phonebook entry, when making a call using the phonebook (Page 40).
<b>Number</b>	Display the telephone number when searching an entry in the phonebook (Page 29).
<b>Update</b>	Update the firmware (Page 52).
<b>A/a</b>	Switch between uppercase and lowercase entry when entering characters (Page 55).
<b>1/A/?</b>	Select the desired character entry mode when entering characters (Page 56).

## Basic Operations

This section explains the basics of using the unit.

### Note

- If KX-UT113/KX-UT123/KX-UT133/KX-UT136 is connected to a Panasonic KX-NS1000 PBX, refer to the documentation of the KX-NS1000 for information about the operation of the unit.

## Confirming Your Extension Number

In stand-by mode (i.e., when you do not have any active calls), you can view the extension number and name registered to the unit.

## Going off- and on-hook

There are several ways to go off-hook and on-hook:

- Using the handset
- Using the **[SP-PHONE/HEADSET/📞/📞]** button
- Using the soft buttons
- For KX-UT133/KX-UT136/KX-UT248, using a DN button (flexible button)

### Going off-hook

In this manual, when you see the phrase "go off-hook", you can do any of the following:

- Lift the handset off of its cradle.
- Press **[SP-PHONE/HEADSET/📞/📞]** while the handset is on its cradle. This enables hands-free mode.
- Press **[SP-PHONE/HEADSET/📞/📞]** when using a headset.
- For KX-UT133/KX-UT136/KX-UT248, press a DN button (flexible button).

### Note

- Certain soft buttons, such as **Answer**, function like the **[SP-PHONE/📞]** button.
- For details about DN buttons, see "Flexible Buttons (KX-UT133/KX-UT136/KX-UT248 only) (Page 39)".

### Going on-hook

In this manual, when you see the phrase "go on-hook", you can do any of the following:

- Replace the handset on its cradle.
- Press **[SP-PHONE/HEADSET/📞/📞]** when using a headset or when you are in hands-free mode.

### Hands-free Mode

In hands-free mode, you can talk and hear the other party in a conversation without using the handset. This mode is useful for performing other tasks during a conversation, such as writing.

#### Enabling hands-free mode

You can enable hands-free mode in one of the following ways:

- In stand-by mode, press **[SP-PHONE/📞]**.
- During a conversation while using the handset, press **[SP-PHONE/📞]**. You can then return the handset to its cradle.
- When receiving an incoming call, press **Answer**.
- For KX-UT133/KX-UT136/KX-UT248, in stand-by mode, press an idle DN button (flexible button).
- For KX-UT133/KX-UT136/KX-UT248, when receiving a call or when a call is on hold, press the flashing green DN button (flexible button) that corresponds to the call.

#### Cancelling hands-free mode

You can cancel hands-free operation simply by lifting the handset off its cradle.

### Note

- For details about DN buttons, see "Flexible Buttons (KX-UT133/KX-UT136/KX-UT248 only) (Page 39)".

### Off-hook monitor

During a two-party conversation with the corded handset, you can allow other people to listen to the conversation through the speaker while you continue the conversation using the handset.

- Press **[SP-PHONE/📞]**, but do not return the handset to its cradle.
- Press **[SP-PHONE/📞]** again to cancel off-hook monitor.

### Note

- When off-hook monitor is active, replacing the handset to its cradle enables hands-free mode.

- During a conference call, pressing **[SP-PHONE/📞]** simply enables hands-free mode. The handset will be disabled.

## Adjusting the Volume

You can adjust the ringer, handset, headset, and speaker volume using **[▲]** and **[▼]** on the Navigator key.

### Adjusting the ringer volume

When receiving a call, press **[▲]** or **[▼]**.

You can also adjust the ringer volume in the settings. For details, see "Ringer (Page 45)".

#### **Note**

- When the ringer volume is turned all the way down, "OFF" is displayed. Also,  is displayed when the unit is in stand-by mode.

### Adjusting the handset/headset/speaker volume

Press **[▲]** or **[▼]** during a conversation when using the handset, headset, or when you are in hands-free mode.

# Feature Operations

## Note

- If KX-UT113/KX-UT123/KX-UT133/KX-UT136 is connected to a Panasonic KX-NS1000 PBX, refer to the documentation of the KX-NS1000 for information about the operation of the unit. However, please refer to this documentation for details about the following features:
  - Phonebook (Page 29, 40)
  - Call Log (Page 30)

## Making Calls

This section explains the basic methods for making a call.

### Making a Call

1. In stand-by mode, go off-hook.
2. Enter the number you want to call.
3. Press **[ENTER]**, or wait a few seconds for the number to be dialled.
4. To end the call, go on-hook.

#### Note

- For KX-UT113/KX-UT123, if more than one line is available at your unit, you can press **[Line]** before going off-hook and then select the line you want to use.
- For KX-UT133/KX-UT136/KX-UT248, if more than one line is available at your unit, you can press an idle DN button (flexible button) assigned to the line you want to use before entering the number. For details about DN buttons, see "Flexible Buttons (KX-UT133/KX-UT136/KX-UT248 only) (Page 39)".

### Pre-dialling

In stand-by mode, you can start dialling (max. 32 digits) while still on-hook.

- To delete a number you entered, press **[Clear]**.
- To clear the entire number, press and hold **[Clear]**.
- To connect the call, go off-hook or press **[ENTER]**.

#### Note

- For KX-UT133/KX-UT136/KX-UT248, you can also press an idle DN button (flexible button) to connect the call. For details about DN buttons,

see "Flexible Buttons (KX-UT133/KX-UT136/KX-UT248 only) (Page 39)".

- For KX-UT113/KX-UT123, when pre-dialling you can press **[Call]** instead of going off-hook. If more than one line is available at your unit, select the line to use, and then press **[ENTER]**.
- If you receive an incoming call during pre-dialling, the display changes to the incoming call screen. For KX-UT133/KX-UT136/KX-UT248, you can close the incoming call screen by pressing **[End]**, and continue pre-dialling.

## Making a Call from the Phonebook List

### Scrolling through all entries

1. Press **[Book]**.
2. Press **[▲]** or **[▼]** to select an entry.
3. Go off-hook.
4. To end the call, go on-hook.

#### Note

- For KX-UT133/KX-UT136/KX-UT248, you can also press an idle DN button (flexible button) in step 3 to connect the call. For details about DN buttons, see "Flexible Buttons (KX-UT133/KX-UT136/KX-UT248 only) (Page 39)".
- For KX-UT113/KX-UT123, you can press **[Call]** instead of going off-hook. If more than one line is available at your unit, select the line to use, and then press **[ENTER]**.
- In step 2, if multiple phone numbers are stored for the entry, you can press **[Number]** and then select the phone number to call.

### Searching by name

1. Press **[Book]**.
2. Press **[Search]**.
3. Enter the name (max. 12 characters) you want to search for.
4. Press **[ENTER]**.  
The entry that matches your search appears.
5. Go off-hook.
6. To end the call, go on-hook.

#### Note

- For KX-UT113/KX-UT123, you can press **[Call]** instead of going off-hook. If more than

one line is available at your unit, select the line to use, and then press **[ENTER]**.

- For details about entering characters, see "Entering Characters (Page 55)".
- In step 4, if multiple phone numbers are stored for the entry, you can press **Number** and then select the phone number to call.
- If you do not press any buttons for 1 minute, the unit will return to stand-by mode.

## Dialling by Using Call Logs

The last 30 incoming calls and outgoing calls are stored in their respective logs, in order of newest to oldest call. Missed incoming calls appear in the missed call log in addition to the incoming call log.

You can make calls to the numbers listed in the call logs.

1. Press **Call Log**.
2. Press **[▲]** or **[▼]** to select the call log type, and then press **[ENTER]**.
3. Press **[▲]** or **[▼]** to select the desired entry.
4. Go off-hook.
5. To end the call, go on-hook.

### Note

- For KX-UT133/KX-UT136/KX-UT248, you can also press an idle DN button (flexible button) in step 4 to connect the call. For details about flexible buttons, see "Flexible Buttons (KX-UT133/KX-UT136/KX-UT248 only) (Page 39)".
- For KX-UT113/KX-UT123, you can press **Call** instead of going off-hook. If more than one line is available at your unit, select the line to use, and then press **[ENTER]**.
- You can add a call log entry to the phonebook. See "Adding a Phonebook Entry from the Incoming or Missed Call Log (Page 40)".

## Editing a phone number before dialling from the incoming or missed call log

You can edit a phone number in the incoming or missed call log before using it to dial.

1. Press **Call Log**.
2. Press **[▲]** or **[▼]** to select "Incoming Call Log" or "Missed Call", and then press **[ENTER]**.
3. Press **[▲]** or **[▼]** to select the desired entry.

4. Do one of the following, depending on your unit:  
**For KX-UT113/KX-UT123 users**

- Press **Menu**, select "Edit", and then press **[ENTER]**.

**For KX-UT133/KX-UT136/KX-UT248 users**

- Press **Edit**.

5. Edit the number, and then go off-hook or press **Call**.
6. To end the call, go on-hook.

## Redialling the Last Number You Dialed (Redial, Last Number)

You can redial the last phone number that you dialed.

1. Press **[REDIAL/☎]**.
2. To end the call, go on-hook.

### Note

- For KX-UT133/KX-UT136/KX-UT248, to select a line to use to redial, press the appropriate DN button (flexible button) before you press **[REDIAL/☎]**. For details about DN buttons, see "Flexible Buttons (KX-UT133/KX-UT136/KX-UT248 only) (Page 39)".
- The unit may be configured to display the outgoing call log instead of immediately redialling. You can select an entry from the call log to make a call (Page 30). For details, consult your administrator or dealer.

## One-touch Dialling (KX-UT133/ KX-UT136/KX-UT248 only)

You can make a call with a One-touch operation if a One-touch Dialling button has been created for the desired party. One-touch Dialling buttons can also be configured to access features of your phone system, if available.

1. Go off-hook, and then press the One-touch Dialling button (flexible button).
2. To end the call, go on-hook.

### Note

- A BLF (Busy Lamp Field) button (flexible button) can also be used to call an extension simply by pressing the button. For details, consult your administrator or dealer.
- For details about flexible buttons such as One-touch Dialling buttons and BLF buttons,

see "Flexible Buttons (KX-UT133/KX-UT136/  
KX-UT248 only) (Page 39)".

## Receiving Calls

This section explains the basic methods for receiving a call.

### Receiving a Call

1. Go off-hook.
2. To end the call, go on-hook.

#### Auto answer

You can have the unit automatically answer an incoming call. The call is connected after a programmed number of rings.

- To enable Auto Answer:  
In stand-by mode, press [AUTO ANSWER/📞] until "Auto Answer On" appears.
- To disable Auto Answer:  
In stand-by mode, press [AUTO ANSWER/📞] until "Auto Answer Off" appears.

#### Note

- When Auto Answer is enabled, **AUTO ANS** appears on the display in stand-by mode.

### Rejecting Calls

You can reject an incoming call at your unit or set the unit to reject certain calls.

#### Rejecting a call while receiving

1. When receiving an incoming call, press **Reject**.

#### Rejecting anonymous calls

You can set the unit to reject calls when the unit receives a call without phone number.

To reject anonymous calls, the Block Anonymous Call setting must be enabled through Web user interface programming (Page 63). For details, consult your administrator or dealer.

#### Note

- Rejected phone numbers will not be stored in the incoming or missed call log.
- Depending on the line an incoming call is arriving on, the call may not be rejected.

## Rejecting specific calls

You can set the unit to reject specific phone numbers.

### Note

- Rejected phone numbers will not be stored in the incoming or missed call log.

### Adding a phone number

You can store a maximum of 30 phone numbers you want to reject in the rejection list of the unit.

- In stand-by mode, press **Setting**.
- Press **[▲]** or **[▼]** to select "Call Block", and then press **[ENTER]**.
- Press **Add**.
- Enter the telephone number (max. 32 digits), and then press **[ENTER]**.

### Note

- To register additional telephone numbers, repeat the procedure from step 3.

### Adding a phone number from the incoming or missed call log

You can add a phone number by referring to the incoming or missed call log.

- In stand-by mode, press **Call Log**.
- Press **[▲]** or **[▼]** to select "Incoming Call Log" or "Missed Call", and then press **[ENTER]**.
- Press **[▲]** or **[▼]** to select the entry with the phone number you want to reject.
- Press **Save**.
- Press **[▲]** or **[▼]** to select "Call Block", and then press **[ENTER]**.
- Press **[▲]** or **[▼]** to select "Yes", and then press **[ENTER]**.

### Note

- If you do not press any buttons for 1 minute, the unit will return to stand-by mode.

### Editing a stored phone number

- In stand-by mode, press **Setting**.
- Press **[▲]** or **[▼]** to select "Call Block", and then press **[ENTER]**.
- Press **[▲]** or **[▼]** to select the phone number you want to edit, and then press **Edit**.
- Edit the phone number as necessary, and then press **[ENTER]**.

### Note

- If you do not press any buttons for 1 minute, the unit will return to stand-by mode.

### Deleting a stored phone number

- In stand-by mode, press **Setting**.
- Press **[▲]** or **[▼]** to select "Call Block", and then press **[ENTER]**.
- Press **[▲]** or **[▼]** to select the phone number you want to delete, and then press **Delete**.
- Press **[▲]** or **[▼]** to select "Yes", and then press **[ENTER]**.

### Note

- If you do not press any buttons for 1 minute, the unit will return to stand-by mode.



## Holding a Call

You can put a call on hold by holding the call at your extension.

### To hold the current call

1. Press **[HOLD/↕]**, and then go on-hook.

#### Note

- For KX-UT133/KX-UT136/KX-UT248, if Automatic Call Hold is enabled on your unit, the call will also be put on hold if you press a DN button (flexible button) other than the one for the current call. For details, consult your administrator or dealer.

### To retrieve a call on hold at your extension

1. Go off-hook.
2. Do one of the following, depending on your unit:

#### For KX-UT113/KX-UT123 users

- Press **[HOLD/↕]**.

#### For KX-UT133/KX-UT136/KX-UT248 users

- Press the green flashing DN button (flexible button).

#### Note

- If a call is not retrieved within a specified time, you will hear an alarm as a reminder (Hold Recall).
- For details about DN buttons, see "Flexible Buttons (KX-UT133/KX-UT136/KX-UT248 only) (Page 39)".

## Receiving a Second Call (Answering Call Waiting)

During a conversation, if a second call arrives, you will hear a call waiting tone.

You can answer the second call by disconnecting or holding the current call.

### To disconnect the current call and then talk to the new party

1. Go on-hook while hearing the call waiting tone.
2. Go off-hook.

### To hold the current call and then talk to the new party

#### For KX-UT113/KX-UT123 users

1. Press **[HOLD/↕]** while hearing the call waiting tone.

#### For KX-UT133/KX-UT136/KX-UT248 users

1. Press **[HOLD/↕]** while hearing the call waiting tone.
2. Press the green flashing DN button (flexible button).

#### Note

- For KX-UT133/KX-UT136/KX-UT248, if Automatic Call Hold is enabled on your unit, you do not need to press **[HOLD/↕]** in step 1. The call is automatically put on hold when you press the DN button. For details, consult your administrator or dealer.
- For details about DN buttons, see "Flexible Buttons (KX-UT133/KX-UT136/KX-UT248 only) (Page 39)".

## Talking to Two Parties Alternately (Call Splitting)

When you are talking to one party and have another party on hold, you can switch the call on hold and the current call.

1. Press [**HOLD/**↕].
2. Call the second party.
3. Do one of the following, depending on your unit:
  - For KX-UT113/KX-UT123 users**
    - Press [**HOLD/**↕].
  - For KX-UT133/KX-UT136/KX-UT248 users**
    - Press [**HOLD/**↕], and then press the green flashing DN button (flexible button) that corresponds to the other party on hold.

### Note

- For KX-UT133/KX-UT136/KX-UT248, if Automatic Call Hold is enabled on your unit, you do not need to press [**HOLD/**↕] in step 3. The call is automatically put on hold when you press the DN button. For details, consult your administrator or dealer.
- For details about DN buttons, see "Flexible Buttons (KX-UT133/KX-UT136/KX-UT248 only) (Page 39)".

## Transferring a Call (Call Transfer)

You can transfer a call to another destination (extension or outside party).

### To transfer

1. Press [**TRANSFER/**↻].
2. Call the party you want to transfer the call to.
3. Wait until the other party answers to announce the transfer.
4. Press **Xfer OK**.

### Note

- If On-hook Transfer is enabled on your unit, you can simply go on-hook in step 4 instead of pressing **Xfer OK**. For details, consult your administrator or dealer.
- If unscreened transfers are supported on your phone system, step 3 can be omitted. For details, consult your administrator or dealer.
- For KX-UT113/KX-UT123, if a call is on hold (Page 33), the transfer operation cannot be performed.

### To do an unscreened (blind) transfer

1. Press **Xfer-Un** during a conversation.
2. Call the party you want to transfer the call to.
3. Go on-hook.

### Note

- For KX-UT113/KX-UT123, if a call is on hold (Page 33), the transfer operation cannot be performed.

## To Transfer with One Touch (One-touch Transfer) (KX-UT133/KX-UT136/KX-UT248 only)

1. Press the BLF button (flexible button) during a conversation.
2. Wait until the other party answers to announce the transfer.
3. Press **Xfer OK**.

### Note

- If On-hook Transfer is enabled on your unit, you can simply go on-hook in step 3 instead of

pressing **Xfer OK**. For details, consult your administrator or dealer.

- If unscreened transfers are supported on your phone system, step **2** can be omitted. For details, consult your administrator or dealer.
- For details about flexible buttons, see "Flexible Buttons (KX-UT133/KX-UT136/KX-UT248 only) (Page 39)".

## Mute

You can mute your voice during a conversation. While the mute feature is turned on, you will be able to hear the other party, but the other party will not be able to hear you.

The built-in microphone, handset, and headset are all muted when the mute feature is turned on.

### To mute/unmute

1. Press **[MUTE/🔇]**.

## Conference Call (Local Three-way Conference)

During a conversation, you can add an additional party to your call and establish a conference call.

### Notice

- Your phone system may support advanced conference features, such as conference calls with four or more parties. In this case, the procedures for handling a conference call may be different from those explained in this section. For details about your phone system, consult your administrator or dealer.

## Making a Conference Call

- Press [**CONFERENCE/CONF/△**] to put the current call on hold.
- Call the party you want to add to the conversation.
- After the called party answers, press [**CONFERENCE/CONF/△**] to begin the conference call.

## Removing a Party from the Conference

During a conference, you can remove other parties from the conference. However, this operation is available only during conference calls you initiate.

### For KX-UT113/KX-UT123 users

- During a conference call, press [**HOLD/↕**].
  - The second party is put on hold, but you can continue talking to the first party.
- Go on-hook.
  - The first party is disconnected.
- Press [**HOLD/↕**].
  - You can continue the conversation with the second party.

### Note

- To disconnect the second party instead of the first party, press [**HOLD/↕**] 2 times in step 1.
- To re-establish the conference without removing either party, press [**CONFERENCE/△**] after step 1.

### For KX-UT133/KX-UT136/KX-UT248 users

- During a conference call, press [**HOLD/↕**].
  - The other parties are put on hold.
- Press the DN button (flexible button) that corresponds to the party you want to disconnect.
  - A conversation is established with the party you want to disconnect.
- Go on-hook.
  - The party is disconnected.
- Press the DN button (flexible button) that corresponds to the remaining party.
  - You can continue the conversation with the remaining party.

### Note

- To re-establish the conference without removing either party, press [**CONFERENCE/CONF/△**] after step 2.
- For details about DN buttons, see "Flexible Buttons (KX-UT133/KX-UT136/KX-UT248 only) (Page 39)".

## Ending a Conference Call

- Go on-hook during a conference.

## Checking Messages

### Checking New Messages

When you receive a voice message, "Message" appears on the display, and the Message/Ringer lamp turns red.

You can check your new messages by accessing your mailbox.

1. Press [MESSAGE/✉].
2. If the unit has multiple lines, press [▲] or [▼] to select the line on which ✉ is displayed, and then go off-hook.

## Checking Missed Calls

When there are new missed calls, "Missed Call: xxx" appears on the display. ("xxx" indicates the number of missed calls.)

1. Press **Call Log**.
2. Press [▲] or [▼] to select "Incoming Call Log" or "Missed Call", and then press [ENTER].
3. Press [▲] or [▼] to select the missed call.

### Note

- In the incoming call log, "Missed" is displayed on missed calls. For KX-UT113/KX-UT123/KX-UT133, you must press [▶] to see this.
- For details about making calls from the call log, see "Dialling by Using Call Logs (Page 30)".
- A check mark is displayed next to answered calls and missed calls that you have already checked.

## Erasing All Call Logs

1. In stand-by mode, press **Call Log**.
2. Press **Delete**.
3. Select "Yes".  
All missed, incoming, and outgoing call logs will be erased.

## Call Forwarding/Do Not Disturb

You can have incoming calls automatically forwarded to another destination. You can also have incoming calls rejected (Do Not Disturb).

### Note

- When Call Forwarding or Do Not Disturb is enabled, **FWD/DND** appears on the display in stand-by mode.

### To access the FWD/DND settings

- In stand-by mode, press **Setting** or **[FORWARD/DO NOT DISTURB/↶/•K←]**.
  - If you press **[FORWARD/DO NOT DISTURB/↶/•K←]**, continue to step 3.
- Press **[▲]** or **[▼]** to select "FWD/DND Setting", and then press **[ENTER]**.
- If the unit has multiple lines, press **[▲]** or **[▼]** to select the desired line, and then press **[ENTER]**.
- Press **[▲]** or **[▼]** to select the type of FWD or DND setting to apply, and then press **[ENTER]**.
- Configure the settings as necessary (Page 46).

## Logging in to or Logging out of a Group (KX-UT133/KX-UT136/KX-UT248 only)

### Logging in to or Logging out of an ACD (Automatic Call Distribution) Group

If the SIP server supports ACD and you are assigned to an ACD group, you can log in to or log out of the group.

- In stand-by mode, press the flexible button assigned as the ACD Log-in/Log-out button.

### Note

- The flexible button's light indicates the status as follows:  
**Off:** logged in to the ACD group  
**Red On:** logged out of the ACD group

### To set/cancel Not Ready mode or to leave Wrap Up mode

Press the flexible button assigned as the Wrap Up button.

The status will change as follows:

**Ready** → Not Ready

**Not Ready** → Ready

**Wrap Up** → Not Ready

### Note

- The Wrap Up button's light shows the current status as follows:  
**Off:** Ready mode for incoming calls  
**Red on:** Not Ready mode for incoming calls  
**Flashing red:** Wrap Up mode

## Flexible Buttons (KX-UT133/KX-UT136/ KX-UT248 only)

The flexible buttons on the unit can be customised to be used to make or receive calls or as feature buttons. These buttons are configured by your administrator or dealer.

The following types of flexible buttons are available:

### DN (Directory Number)

Seizes the line assigned to the DN button. When a call arrives at the DN button, pressing the button answers the call.

#### Lamp Indication

- **Off:** Idle
- **Green on:** You are on a call using the DN button.
- **Flashing green rapidly:** A call is being received.
- **Flashing green slowly:** A call is on hold.
- **Red on:** A shared line is in use or on hold (private) at another unit.
- **Flashing red slowly:** A shared line is on hold (normal) at another unit.

#### Note

- A ringtone can be assigned to each DN button through Web user interface programming. When a call arrives at a DN button, the ringtone assigned to that button plays. For details, consult your administrator or dealer. However, if you select a ringtone through the unit's settings (Page 45), that ringtone will play instead of those assigned to DN buttons.
- A shared line is a line that can be used by multiple units. This is an optional feature and may not be supported on your phone system.

### One-Touch

Calls the party or accesses a feature assigned to the button. See "One-touch Dialling (KX-UT133/KX-UT136/KX-UT248 only) (Page 30)".

### Headset

Enables or disables talking using the headset.

#### Lamp Indication

- **Off:** Headset off
- **Red on:** Headset on

### BLF (Busy Lamp Field)

Calls the extension assigned to the button. During a conversation, a BLF button can be used to transfer calls to the assigned extension (Page 34). A BLF button's lamp also shows the current status of the assigned extension.

#### Lamp Indication

- **Off:** The assigned extension is idle.
- **Red on:** The assigned extension is using the line.
- **Flashing red rapidly:** The assigned extension is receiving an incoming call. If enabled through Web user interface programming, pressing the button answers the call (Directed Call Pickup).

#### Note

- BLF (Busy Lamp Field) is an optional feature and may not be supported on your phone system.

### ACD

Logs in to or logs out of a group when ACD (Automatic Call Distribution) is enabled (Page 38).

#### Lamp Indication

- **Off:** Logged in
- **Red on:** Logged out

#### Note

- ACD is an optional feature and may not be supported on your phone system.

### Wrap Up

The Wrap Up button alternates the setting of Wrap Up mode, Not Ready mode or Ready mode for incoming calls.

In Wrap Up mode/Not Ready mode for incoming calls, incoming calls will not be received through the ACD (Automatic Call Distribution) group.

#### Lamp Indication

- **Off:** Ready mode for incoming calls
- **Red on:** Not Ready mode for incoming calls
- **Flashing red:** Wrap Up mode

#### Note

- Wrap Up is an optional feature and may not be supported on your phone system.

# Customising the Telephone

## Phonebook List

### Adding a New Phonebook Entry

You can add a maximum of 500 (for KX-UT123/KX-UT133/KX-UT136/KX-UT248) or 100 (for KX-UT113) phonebook entries to the unit. To make a call from the phonebook, see "Making a Call from the Phonebook List (Page 29)".

1. Press **☰**.
2. Press **Add**.
3. Enter a name (max. 24 characters), and then press **[ENTER]**.
4. Press **[▲]** or **[▼]** to select the phone number type (**①** to **⑤**) or "Ringtone X", and then press **[ENTER]**.
5. Do one of the following, depending on your selection in the previous step:
  - If you selected a phone number type**
    - Enter the phone number (max. 32 digits), and then press **[ENTER]**.
  - If you selected "Ringtone X"**
    - Select a ringtone to play when you receive a call from this party, and then press **[ENTER]**.
6. To add another phone number to the entry, repeat the procedure from step 4.
7. Press **Save**.

#### Note

- If you store multiple phone numbers in the entry, you can assign the preferred number to use when you call this party. In step 4, select the desired number, and then press **Default**.
- If you do not press any buttons for 1 minute, the unit will return to stand-by mode.

### Adding a Phonebook Entry from the Incoming or Missed Call Log

You can add new phonebook entries from the incoming or missed call log.

1. Press **Call Log**.
2. Press **[▲]** or **[▼]** to select "Incoming Call Log" or "Missed Call", and then press **[ENTER]**.

3. Press **[▲]** or **[▼]** to select the desired call log entry, and then press **Save**.
4. Select "Phonebook", and then press **[ENTER]**.
5. Enter a name (max. 24 characters), and then press **[ENTER]**.
6. Press **[▲]** or **[▼]** to select the phone number type (**①** to **⑤**) or "Ringtone X", and then press **[ENTER]**.
7. Do one of the following, depending on your selection in the previous step:
  - If you selected a phone number type**
    - Enter the phone number (max. 32 digits), and then press **[ENTER]**.
  - If you selected "Ringtone X"**
    - Select a ringtone to play when you receive a call from this party, and then press **[ENTER]**.
8. To add another phone number to the entry, repeat the procedure from step 6.
9. Press **Save**.

#### Note

- If a name is stored in the call log, it is automatically entered in step 5.
- If you store multiple phone numbers in the entry, you can assign the preferred number to use when you call this party. In step 6, select the desired number, and then press **Default**.
- If you do not press any buttons for 1 minute, the unit will return to stand-by mode.

### Editing a Phonebook Entry

You can edit the information stored in phonebook entries.

1. Press **☰**.
2. Press **[▲]** or **[▼]** to display the desired entry, or press **Search** and search for the desired entry (Page 41).
3. Do one of the following, depending on your unit:
  - For KX-UT113/KX-UT123 users**
    - Press **Menu**, select "Edit", and then press **[ENTER]**.
  - For KX-UT133/KX-UT136/KX-UT248 users**
    - Press **Edit**.
4. Press **[▲]** or **[▼]** to select the item you want to edit, and then press **[ENTER]**.



5. Edit the item as necessary, and then press [ENTER].
6. Press **Save**.

**Note**

- If you store multiple phone numbers in the entry, you can assign the preferred number to use when you call this party. In step 4, select the desired number, and then press **Default**.
- If you do not press any buttons for 1 minute, the unit will return to stand-by mode.

## Searching for a Phonebook Entry

You can search the phonebook for the desired entry.

1. Press **Book**.
2. Press **Search**.
3. Enter the name you want to search for, and then press [ENTER].

## Deleting a Phonebook Entry

You can delete phonebook entries.

1. Press **Book**.
2. Press [▲] or [▼] to display the desired entry, or press **Search** and search for the desired entry (Page 41).
3. Do one of the following, depending on your unit:
  - For KX-UT113/KX-UT123 users**
    - Press **Menu**, select "Delete", and then press [ENTER].
  - For KX-UT133/KX-UT136/KX-UT248 users**
    - Press **Delete**.
4. Press [▲] or [▼] to select "Yes", and then press [ENTER].

## Export/Import Phonebook Entries

You can export the phonebook entries through the Web user interface to your computer as a tab separated value file. This makes it possible to add and edit phonebook entries using a spreadsheet application or text editor on your computer. After editing, the file should be imported into the unit.

Also, phonebook entries exported from one unit can be imported into another, which makes it easy to share phonebook entries.

To export/import entries, consult your administrator or dealer.

**Notice**

- If you export the phonebook, delete some entries on your computer, and then import the phonebook to the unit, the entries deleted on your computer will not be deleted from the unit's phonebook. To erase unnecessary entries, use the unit's interface and not the Web user interface.

**Note**

- Phone calls cannot be made or received while phonebook entries are being imported or exported.
- If KX-UT113/KX-UT123/KX-UT133/KX-UT136 is connected to a KX-NS1000 PBX, you cannot export or import phonebook entries.

## User Settings

You can configure various settings to customise the behaviour of the unit. This section explains how to configure the settings using the unit.

### Accessing the Settings

1. In stand-by mode, press **Setting**.
2. Press **[▲]** or **[▼]** to select the desired setting category, and then press **[ENTER]**.
3. Configure the settings as necessary.

## Available Settings

└ Ringer	└ Ringer Volume		Page 45
	└ Ringtone		Page 45
└ ECO Mode			Page 45
└ LCD Contrast			Page 45
└ Backlight			Page 46
└ Display Lock			Page 46
└ Key Click Tone			Page 46
└ FWD/DND Setting <sup>1</sup>	└ Do Not Disturb		Page 46
	└ FWD All		Page 47
	└ FWD Busy		Page 47
	└ FWD No Ans		Page 47
└ Language			Page 48
└ Date and Time			Page 48
└ Information Display			Page 49
└ Network Settings	└ Network	└ DHCP	Page 49
		└ DNS	Page 50
		└ DNS1 <sup>2</sup>	Page 50
		└ DNS2 <sup>2</sup>	Page 50
		└ STATIC	Page 50
		└ IP Address	Page 50
		└ Subnet mask	Page 50
		└ Default Gateway	Page 50
		└ DNS1	Page 50
		└ DNS2	Page 50
	└ LLDP-MED <sup>4</sup>	└ On/Off	Page 50
		└ Timer	Page 50
		└ PC port	Page 50
	└ VLAN	└ Enable VLAN	Page 51
		└ IP Phone	Page 51
		└ PC <sup>3</sup>	Page 51
	└ Speed/Duplex	└ LAN port	Page 51
		└ PC port <sup>3</sup>	Page 51
	└ Embedded web <sup>4</sup>		Page 51
	└ Authentication	└ ID	Page 51

	└ Password	Page 51	
└ Network Test		Page 52	
└ Restart		Page 52	
└ Firmware version		Page 52	
└ Call Block		Page 53	
└ Bluetooth Headset <sup>5</sup>	└ Add new device	└ Enter PIN	Page 54
	└ Disconnect		Page 54
	└ Connect		Page 54
	└ Deregistration		Page 54

<sup>1</sup> For details about the FWD/DND settings when KX-UT113/KX-UT123/KX-UT133/KX-UT136 is connected to a KX-NS1000 PBX, refer to the documentation of the KX-NS1000.

<sup>2</sup> This setting is available only if "DNS" is set to "Manual".

<sup>3</sup> This setting is available only on KX-UT123/KX-UT133/KX-UT136/KX-UT248.

<sup>4</sup> This setting is not available if KX-UT113/KX-UT123/KX-UT133/KX-UT136 is connected to a KX-NS1000 PBX.

<sup>5</sup> This setting is available only on KX-UT248.

## Settings Details

### Ringer

Setting	Description	Value Range	Default
Ringer Volume	Adjust the ringer volume.	Level 0 to 6	Level 3
Ringtone	Select a ringtone to play when you receive a call. If multiple lines are configured on your unit, you must first select which line to use the ringtone for. You can assign a different ringtone to each line. If you select " <b>Automatic</b> " (KX-UT133/KX-UT136/KX-UT248 only), the ringtone assigned through Web user interface programming (Page 63) will be used. Each ringtone will play as you highlight it.	<KX-UT113/ KX-UT123> Ringtone 1– Ringtone 32  <KX-UT133/ KX-UT136/ KX-UT248> Automatic, Ringtone 1–Ringtone 32	<KX-UT113/ KX-UT123> Ringtone 1  <KX-UT133/ KX-UT136/ KX-UT248> Automatic

#### Note

- The preset melodies in this product are used with permission of © 2009 Copyrights Vision Inc.
- Ringtone 20 to Ringtone 24 are the same as Ringtone 1.
- Even if you have turned the volume off (level 0), each ringtone will still play when you highlight it. However, nothing plays when you highlight "**Automatic**".
- Ringtones can also be assigned to individual entries in the phonebook list (Page 40).
- For KX-UT133/KX-UT136/KX-UT248, ringtones may also be assigned to individual DN buttons (flexible buttons, Page 39) through Web user interface programming (Page 63). However, ringtones specified here override the DN button settings. For details, consult your administrator or dealer.

### ECO Mode

Setting	Description	Value Range	Default
ECO Mode	Enabling this mode reduces the amount of electricity consumed by the unit.	On, Off	Off

#### Note

- When ECO mode is enabled, the Speed/Duplex setting (Page 51) changes as follows:
  - Speed/Duplex: "**10M-Full**"
  - PC port cannot be used.
- When the ECO mode setting is changed, the unit will restart.
- When ECO mode is enabled, **ECO** is displayed while the unit is in stand-by mode.

### LCD Contrast

Setting	Description	Value Range	Default
LCD Contrast	Change the contrast of the display.	Level 1 to 6	Level 3

## Backlight (KX-UT123/KX-UT133/KX-UT136/KX-UT248 only)

Setting	Description	Value Range	Default
Backlight	Change the settings for the backlight.	Always On Automatic Always Off	Automatic
	If you select "Always On" or "Automatic", press [▲] or [▼] to adjust the brightness.	<KX-UT123/ KX-UT133/ KX-UT136> Level 1 to 3  <KX-UT248> Level 1 to 6	<KX-UT123/ KX-UT133/ KX-UT136> Level 3  <KX-UT248> Level 6

### Note

- When "Automatic" is selected, the backlight turns off when the phone returns to an idle state.

## Display Lock

Setting	Description	Value Range	Default
Display Lock	Lock access to your call log and phonebook list by entering your extension PIN (Personal Identification Number).	On, Off	Off

### Note

- The extension PIN can be configured through Web user interface programming. For details, consult your administrator or dealer.

## Key Click Tone

Setting	Description	Value Range	Default
Key Click Tone	Select whether a tone is heard in response to key presses. If you select "Automatic", the setting assigned through Web user interface programming (Page 63) will be used.	Automatic, On, Off	Automatic

## FWD/DND Setting

If multiple lines are available at your unit, press [▲] or [▼] to select the line to apply the settings to when you select "FWD/DND Setting".

Setting	Description	Value Range	Default
Do Not Disturb	Enable DND (Do Not Disturb) to reject all incoming calls.	On, Off	Off

Setting	Description	Value Range	Default
FWD All	Forward all incoming calls to a specified destination.	—	—
On/Off	Enable or disable the "FWD All" setting.	On, Off	Off
Phone Number	Specify the number to forward calls to when "FWD All" is enabled.	1–32 digits	—
FWD Busy	Forward incoming calls to a specified destination when you are on a call.	—	—
On/Off	Enable or disable the "FWD Busy" setting.	On, Off	Off
Phone Number	Specify the number to forward calls to when "FWD Busy" is enabled.	1–32 digits	—
FWD No Ans	Forward incoming calls to a specified destination if you do not answer after a specified number of rings.	—	—
On/Off	Enable or disable the "FWD No Ans" setting.	On, Off	Off
Phone Number	Specify the number to forward calls to when "FWD No Ans" is enabled.	1–32 digits	—
Ring count	After you specify the phone number to forward calls to, enter the number of times the unit will ring before forwarding the call.	0, 2–20	3

**Note**

- For details about the FWD/DND settings when KX-UT113/KX-UT123/KX-UT133/KX-UT136 is connected to a KX-NS1000 PBX, refer to the documentation of the KX-NS1000.

## Language

Setting	Description	Value Range	Default
Language	Select the language to use for the display.	Bosanski Čeština Dansk Deutsch (DE) English (UK) English (US) Español Français Français (Canada) Hrvatski Italiano Magyar Nederlands Polski Português Română Slovenčina Slovenščina Srpski Svenska Türkçe Ελληνικά Русский Українська	English (US)

## Date and Time

Setting	Description	Value Range	Default
Date and Time	Set the date and time.	Date <sup>1</sup> : dd/mm/yyyy or mm/dd/yyyy Time <sup>2</sup> : 00:00–23:59 or 12:00–11:59 AM/ PM	—

<sup>1</sup> Pressing [#] switches the date format.

<sup>2</sup> If the time format is not assigned in the configuration data, you can change the time format (12-hour or 24-hour) by pressing [\*].  
If the time format is set to 12-hour time in the configuration data, you can change the AM/PM setting by pressing [\*].

### Note

- Summer time can be set through Web user interface programming. For details, consult your administrator or dealer.



## Information Display

Setting	Description	Value Range	Default
Information Display	<p>View a variety of information about the unit. Press <b>[▲]</b> and <b>[▼]</b> to display the various settings. The following settings can be viewed:</p> <ul style="list-style-type: none"> <li>• Registration status to the SIP server</li> <li>• IP address</li> <li>• Subnet mask address</li> <li>• Default gateway address</li> <li>• IP address of the DNS server 1</li> <li>• IP address of the DNS server 2</li> <li>• LLDP-MED</li> <li>• LLDP-Timer</li> <li>• IP Phone-VLAN ID</li> <li>• IP Phone-Priority</li> <li>• PC-VLAN ID</li> <li>• PC-Priority</li> <li>• ACS status</li> <li>• Display lock status</li> <li>• Firmware version</li> <li>• Bluetooth headset status (KX-UT248 only)</li> <li>• MAC address</li> </ul>	—	—

## Network Settings

### **IMPORTANT**

We recommend configuring these settings with your administrator or dealer. Network settings can also be configured through Web user interface programming (Page 63). Contact your administrator or dealer for further information.

Setting	Description	Value Range	Default
Network	<p>Configure the basic network settings. If you select "<b>DHCP</b>", you must then select whether the DNS setting is configured automatically or manually. If you select "<b>STATIC</b>", you must manually specify the IP address, subnet mask, default gateway, and DNS servers.</p>	DHCP, STATIC	—
<p><b>When DHCP is selected</b></p>			

Setting	Description	Value Range	Default
DNS	Select whether the DNS server information should be obtained automatically (i.e., provided by the DHCP server) or if you will specify it manually. If you select " <b>Manual</b> ", see " <b>DNS1</b> " and " <b>DNS2</b> " below.	Manual, Automatic	Automatic
DNS1 <sup>1</sup> (Manual DNS only)	Enter the IP address of the primary DNS server.	xxx.xxx.xxx.xxx	—
DNS2 <sup>1</sup> (Manual DNS only)	Enter the IP address of the secondary DNS server. If a secondary DNS server is not required, leave this item blank.	xxx.xxx.xxx.xxx	—
<b>When STATIC is selected</b>			
IP Address <sup>1</sup>	Enter the IP address to assign to the unit.	xxx.xxx.xxx.xxx	—
Subnet mask <sup>1</sup>	Enter the subnet mask for your network.	xxx.xxx.xxx.xxx	—
Default Gateway <sup>1</sup>	Enter the IP address of the default gateway for your network.	xxx.xxx.xxx.xxx	—
DNS1 <sup>1</sup>	Enter the IP address of the primary DNS server.	xxx.xxx.xxx.xxx	—
DNS2 <sup>1</sup>	Enter the IP address of the secondary DNS server. If a secondary DNS server is not required, leave this item blank.	xxx.xxx.xxx.xxx	—
LLDP-MED <sup>3,4</sup>	Configure the LLDP-MED settings.	—	—
On/Off	Enable or disable the "LLDP-MED" setting.	On, Off	On
Timer	Specify the LLDP Interval timer.	1–3600 seconds	30
PC port (KX-UT123/ KX-UT133/KX-UT136/ KX-UT248 only)	Specify the necessary settings for using a PC over a VLAN.	—	—
VLAN ID	Specify the VLAN ID.	0–4094	0
Priority	Specify the priority of packets sent from this unit.	0–7	0
VLAN	Configure the VLAN (Virtual LAN) settings.	—	—

Setting	Description	Value Range	Default
Enable VLAN	Select whether to enable the VLAN functionality.	Yes, No	No
IP Phone	Specify the necessary settings for using the phone features over a VLAN.	—	—
VLAN ID	Specify the VLAN ID.	1–4094	2
Priority	Specify the priority of packets sent from this unit.	0–7	7
PC (KX-UT123/ KX-UT133/KX-UT136/ KX-UT248 only)	Specify the necessary settings for using a PC over a VLAN.	—	—
VLAN ID	Specify the VLAN ID.	1–4094	1
Priority	Specify the priority of packets sent from this unit.	0–7	0
Speed/Duplex	Select the connection mode (combination of link speed and duplex mode) of the LAN port and PC port.	—	—
LAN port <sup>2</sup>	Select the connection mode of the LAN port.	Auto, 10M-Full, 10M-Half, 100M-Full, 100M-Half	Auto
PC port <sup>2</sup> (KX-UT123/ KX-UT133/KX-UT136/ KX-UT248 only)	Select the connection mode of the PC port.	Auto, 10M-Full, 10M-Half, 100M-Full, 100M-Half	Auto
Embedded web <sup>3</sup>	Enable or disable Web User Interface Programming.	On, Off	Off
Authentication	Configure the HTTP authentication ID and password <sup>5</sup>	—	—
ID	Enter the authentication ID.	Max 64 characters <sup>6</sup>	Not stored.
Password	Enter the authentication password.	Max 64 characters <sup>6</sup>	Not stored.

<sup>\*1</sup> Press **[▲]** and **[▼]** to switch between these items.

<sup>\*2</sup> The KX-UT248 supports Gigabit Ethernet. When connecting to a network that supports Gigabit Ethernet, select "Auto". For details, consult your administrator or dealer.

<sup>\*3</sup> This setting is not available if KX-UT113/KX-UT123/KX-UT133/KX-UT136 is connected to a KX-NS1000 PBX.

<sup>\*4</sup> LLDP: Link Layer Discovery Protocol, MED: Media Endpoint Discovery

<sup>\*5</sup> After these settings are changed, the phone will reboot automatically.

## Customising the Telephone

---

If these settings are configured using Web User Interface Programming, this item is not displayed.

<sup>6</sup> This item cannot contain any of the following: " & : < > space.

## Network Test

Setting	Description	Value Range	Default
Network Test	Confirm whether other network devices (e.g., SIP server, routers, switching hubs) respond to network requests. When you select this item, enter the IP address of the device to which you want to test the connection. If a device does not respond, first check the unit's network settings, and then check the device's network settings and connection.	xxx.xxx.xxx.xxx	—

## Restart

Setting	Description	Value Range	Default
Restart	Restart the unit (Page 80).	—	—

## Firmware version

Setting	Description	Value Range	Default
Firmware version	View the version of the currently installed firmware. If a newer version is available, its version is also displayed. In this case, press <b>Update</b> to update the firmware.	—	—

### Note

- Your phone system dealer may offer new features or an improved version of the unit's software from time to time. If you set the unit software update setting to manual mode through the Web user interface, you need to download the update when "Update version. Press OK." is displayed. Contact your administrator or dealer for further information.

## Call Block

Setting	Description	Value Range	Default
Call Block	<p>Register telephone numbers so that calls received from those numbers are blocked. You can also delete registered numbers.</p> <p><b>To register</b></p> <ol style="list-style-type: none"> <li>1. Press <b>Add</b>.</li> <li>2. Enter the telephone number to block, and then press <b>[ENTER]</b>.</li> </ol> <p><b>To edit</b></p> <ol style="list-style-type: none"> <li>1. Press <b>[▲]</b> or <b>[▼]</b> to select the blocked telephone number to edit.</li> <li>2. Press <b>Edit</b>.</li> <li>3. Edit the number as necessary, and then press <b>[ENTER]</b>.</li> </ol> <p><b>To delete</b></p> <ol style="list-style-type: none"> <li>1. Press <b>[▲]</b> or <b>[▼]</b> to select the blocked telephone number to delete.</li> <li>2. Press <b>Delete</b>.</li> <li>3. Select "Yes", and then press <b>[ENTER]</b>.</li> </ol>	—	—

## Bluetooth Headset (KX-UT248 only)

Setting	Description	Value Range	Default
Bluetooth Headset	Configure the Bluetooth headset settings.	—	—
<b>When a Bluetooth headset is not registered</b>			
Add new device	Register a Bluetooth headset on the unit.	—	—
Enter PIN	Enter the Pass Key for your Bluetooth headset.	1–4 digits	0000
<b>When a Bluetooth headset is registered</b>			
Disconnect	Disconnect the Bluetooth headset from the unit when the Bluetooth headset is registered to the unit.	—	—
Connect	Connect the Bluetooth headset to the unit when the Bluetooth headset is registered to the unit.	—	—
Deregistration	Deregister a Bluetooth headset from the unit.	—	—

## Entering Characters

The dial keys are used to enter characters and numbers. Each dial key has multiple characters assigned to it. (For example, A, B and C are assigned to the 1 key.)

To enter a character, press the corresponding dial key until the character you want appears. To enter another character that is assigned to the same key, first press [▶] to move the cursor to the right.

### Example

To enter "DESK", press the keys as follows:

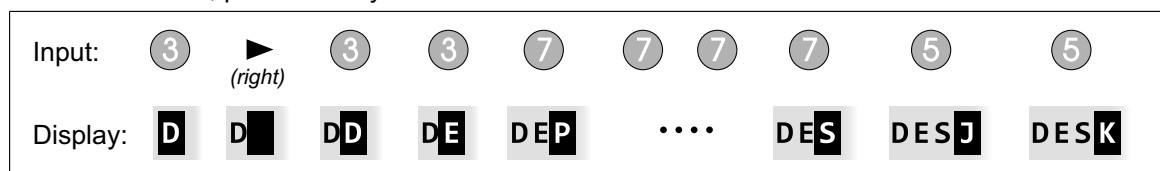

For details about the characters assigned to each key, see "Character Tables (Page 57)".

### Deleting characters

Press **Clear** to delete the last character entered.



### Note

- Press and hold **Clear** to delete all entered text.

### Switching between uppercase and lowercase

Press **A/a** to switch between uppercase entry and lowercase entry.

### Modifying entered text

Use [◀] and [▶] to move the cursor to where you want to modify the text. Then, modify the text as follows:

- Press **Clear** to delete the character under the cursor.



- Press a dial key to insert a character at the cursor's location.

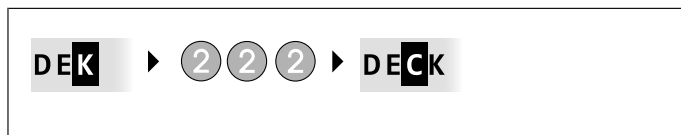

- Press **A/a** to change the case of the character under the cursor.



### **Note**

- If the maximum number of characters has been entered, entering another character will overwrite the character under the cursor.
- If the entered texts spans two or more lines, you can also move the cursor using **[▲]** and **[▼]**.

### **Character entry modes**

The six character entry modes let you enter a variety of characters.

The following character modes are available:

- Latin (ABC)
- Numeric (0–9)
- Greek (ΑΒΓ)
- Extended 1 (ĂĂĂ)
- Extended 2 (ŠŠŠ)
- Cyrillic (АБВ)

For details about which characters are available in each mode, see "Character Tables (Page 57)".

### **To select a character mode**

1. When entering characters, press **1/A/?**.
2. Press **[▲]** or **[▼]** to select the desired character entry mode.
3. Press **[ENTER]**.

### **Note**

- Depending on the type of information you are entering, you cannot change character modes. For example, when you are entering a phone number, only numeric mode is available.



## Character Tables

### ABC (Latin)

Button	Characters
①	! ? " 1 ----- ! ? " 1
②	A B C 2 ----- a b c 2
③	D E F 3 ----- d e f 3
④	G H I 4 ----- g h i 4
⑤	J K L 5 ----- j k l 5
⑥	M N O 6 ----- m n o 6
⑦	P Q R S 7 ----- p q r s 7
⑧	T U V 8 ----- t u v 8
⑨	W X Y Z 9 ----- w x y z 9
⑩	<Space> . , ' : ; 0 ----- <Space> . , ' : ; 0
* ⑩	/ + - = < > * ----- / + - = < > *
# ⑩	\$ % & @ ( ) € £ # ----- \$ % & @ ( ) € £ #

#### Note

- For each button, the upper row shows the characters entered in uppercase mode, and the lower row shows the characters entered in lowercase mode.

**0-9 (Numeric)**

Button	Characters
①	1
②	2
③	3
④	4
⑤	5
⑥	6
⑦	7
⑧	8
⑨	9
⑩	0
*	*
#	#

**ABΓ (Greek)**

Button	Characters
①	! ? " 1 ----- ! ? " 1
②	A B Γ 2 ----- α β γ 2
③	Δ Ε Ζ 3 ----- δ ε ζ 3
④	Η Θ Ι 4 ----- η θ ι 4
⑤	Κ Λ Μ 5 ----- κ λ μ 5
⑥	Ν Ξ Ο 6 ----- ν ξ ο 6
⑦	Π Ρ Σ 7 ----- π ρ σ 7
⑧	Τ Υ Φ 8 ----- τ υ φ 8
⑨	Χ Ψ Ω Υ 9 ----- χ ψ ω υ 9
⑩	<Space> . , ' : ; 0 ----- <Space> . , ' : ; 0
* ⊗	/ + - = < > * ----- / + - = < > *
#	\$ % & @ ( ) € £ # ----- \$ % & @ ( ) € £ #

**Note**

- For each button, the upper row shows the characters entered in uppercase mode, and the lower row shows the characters entered in lowercase mode.

**AÄÅ (Latin Extended 1)**

Button	Characters
①	! ? " 1 ! ? " 1
②	A À Á Â Ã Ä Å Æ B C Ç 2 a à á â ã ä å æ b c ç 2
③	D Đ E È É Ê Ë Ì Í Î Ï 3 d ð e è é ê ë ì í î ï 3
④	G Ğ H I Ì Í Î Ï 4 g ğ h i ì í î ï 4
⑤	J K L 5 j k l 5
⑥	M N Ñ O Ò Ó Ô Õ Ö Ø Æ 6 m n ñ o ò ó ô õ ö ø æ 6
⑦	P Q R S Ş ß 7 p q r s ş ß 7
⑧	T U Û Ú Û Ü Õ V 8 t u ù ú û ü õ v 8
⑨	W Ŵ X Y Ŷ Z 9 w ŵ x y ŷ z 9
⑩	<Space> . , ' : ; 0 <Space> . , ' : ; 0
*	/ + - = < > * / + - = < > *
#	\$ % & @ ( ) € £ # \$ % & @ ( ) € £ #

**Note**

- For each button, the upper row shows the characters entered in uppercase mode, and the lower row shows the characters entered in lowercase mode.

**SŠŠ (Latin Extended 2)**

Button	Characters
①	! ? " 1 ----- ! ? " 1
②	A Á Ā Ą Ą B C Č Ć 2 ----- a á ä ä a b c ć ć 2
③	D Ď E Ě Ę Ę F 3 ----- d d' e é ę ę f 3
④	G H I Í 4 ----- g h i í 4
⑤	J K L Ł Ł Í Ĳ 5 ----- j k l ł ł í Ĳ 5
⑥	M N Ń Ņ ņ Ó Ó Ö Ö 6 ----- m n ń ņ ņ o ó ö ö 6
⑦	P Q R Ř Ř S Ś Š 7 ----- p q r ř ř s ś š 7
⑧	T Ŧ Ţ Ť U Ú Û Ů Ů V 8 ----- t ŧ ŧ ŧ u ú ù ú ú v 8
⑨	W X Y Ÿ Ý Z Ž Ž Ž 9 ----- w x y ÿ ý z ž ž ž 9
⑩	<Space> . , ' : ; 0 ----- <Space> . , ' : ; 0
* (star)	/ + - = < > * ----- / + - = < > *
# (hash)	\$ % & @ ( ) € £ # ----- \$ % & @ ( ) € £ #

**Note**

- For each button, the upper row shows the characters entered in uppercase mode, and the lower row shows the characters entered in lowercase mode.

**АБВ (Cyrillic)**

Button	Characters
①	А Б В ! ? " 1 а б в ! ? " 1
②	Г Д Е Ё 2 г д е ё 2
③	Ж З И Й 3 ж з и й 3
④	К Л М 4 к л м 4
⑤	Н О П 5 н о п 5
⑥	Р С Т 6 р с т 6
⑦	У Ф Х 7 у ф х 7
⑧	Ц Ч Ш 8 ц ч ш 8
⑨	Щ Ъ Ы Ь 9 щ ъ ы ь 9
⑩	Э Ю Я <Space> . , ' : ; 0 э ю я <Space> . , ' : ; 0
* ⑩	/ + - = < > Г € I İ * / + - = < > г е і і *
# ⑩	\$ % & @ ( ) € I Ё # \$ % & @ ( ) € і ё #

**Note**

- For each button, the upper row shows the characters entered in uppercase mode, and the lower row shows the characters entered in lowercase mode.

# Web User Interface Programming

The unit provides a Web-based interface for configuring various settings and features, including some that are not programmable directly from the unit. The following list contains some useful features that are programmable through the Web user interface.

For details, consult your administrator or dealer.

- Basic network settings<sup>\*1</sup> (Page 49)
- User password (for access to Web user interface)
- HTTP authentication settings
- Date and time settings<sup>\*1</sup> (Page 48)
- Default outgoing line
- Call rejection phone numbers<sup>\*1</sup> (Page 53)
- Block caller ID
- Block anonymous calls
- Do Not Disturb<sup>\*1</sup> (Page 46)
- Call forward<sup>\*1</sup> (Page 46)
- Flexible button settings (Page 39) (DN, One-Touch, Headset, etc. KX-UT133/KX-UT136/KX-UT248 only)
- Key click tone
- Extension PIN
- Phonebook import and export (Page 41)

<sup>\*1</sup> These settings can also be configured directly through the unit.

## Notice

- Each time you want to access the Web user interface, you must enable Web programming (Page 51).
- Web user interface programming is not available if KX-UT113/KX-UT123/KX-UT133/KX-UT136 is connected to a KX-NS1000 PBX.

# Installation and Setup

## Notice

- Panasonic assumes no responsibility for injuries or property damage resulting from failures arising out of improper installation or operation inconsistent with this documentation.

## Attaching/Removing the Stand

### Attaching the Stand

#### Notice

- If you place the display face down when you attach the stand, be sure to place a soft cloth under the display. Failure to do so may result in damage to the display.

#### For KX-UT113/KX-UT123:

1. Insert the catches of the stand into hooks located in the unit.
2. Gently push the stand in the direction indicated until it locks into place.  
The stand will be mounted.

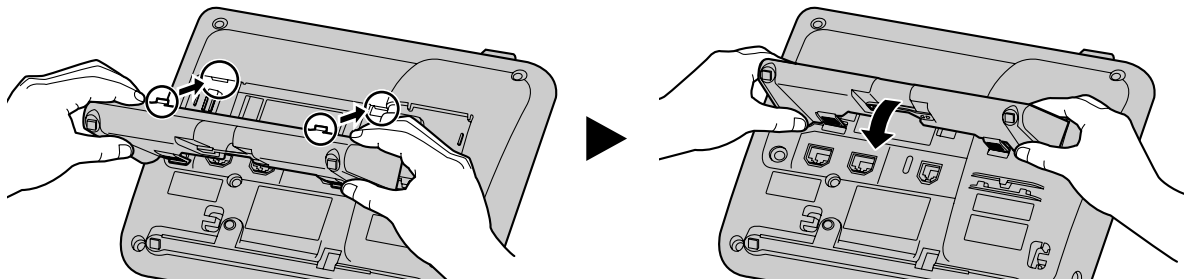

#### For KX-UT133/KX-UT136/KX-UT248:

1. Insert the catches (A) of the stand into hooks located in the unit.
2. Gently push the stand in the direction indicated until it locks into place.  
The stand will be mounted in the high position.

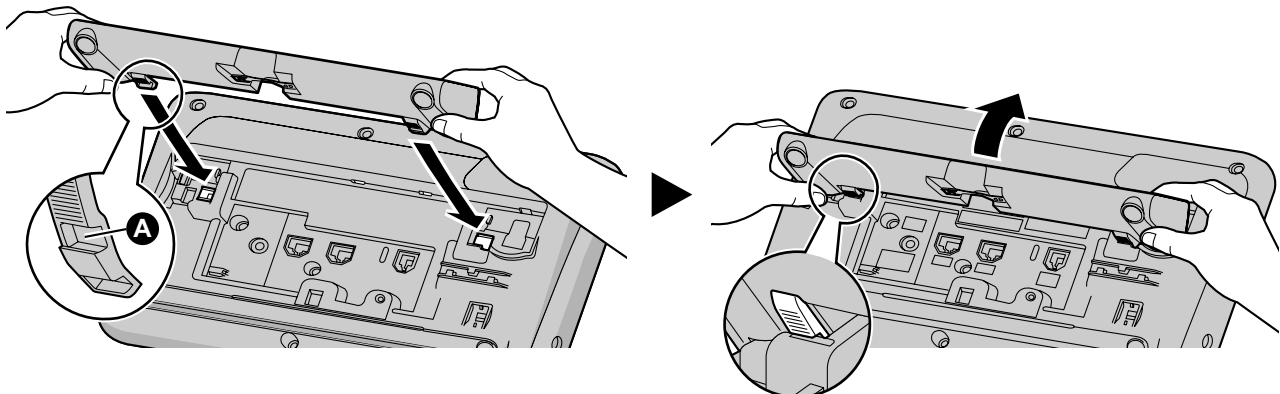



## Removing the Stand

**For KX-UT113/KX-UT123:**

1. Remove the stand in the direction indicated while pushing the catches of the stand with both hands as shown.

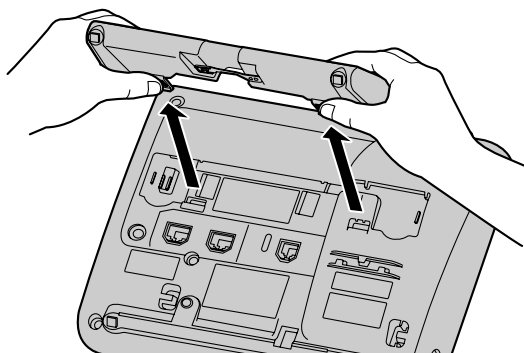

**For KX-UT133/KX-UT136/KX-UT248:**

1. Hold the stand with both hands.
2. Gently rotate the stand in the direction indicated until it is released.

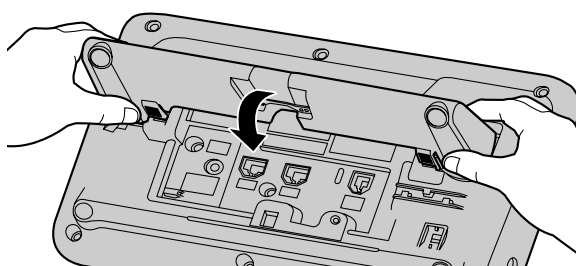

## Adjusting from High to Low Position (KX-UT133/KX-UT136/KX-UT248 only)

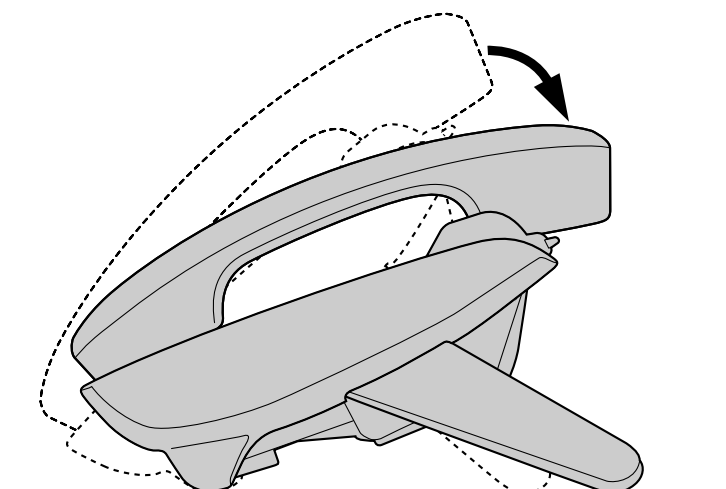

1. Tilt the stand in the direction indicated while pushing the PUSH mark with both hands as shown until it locks into the low position (B).

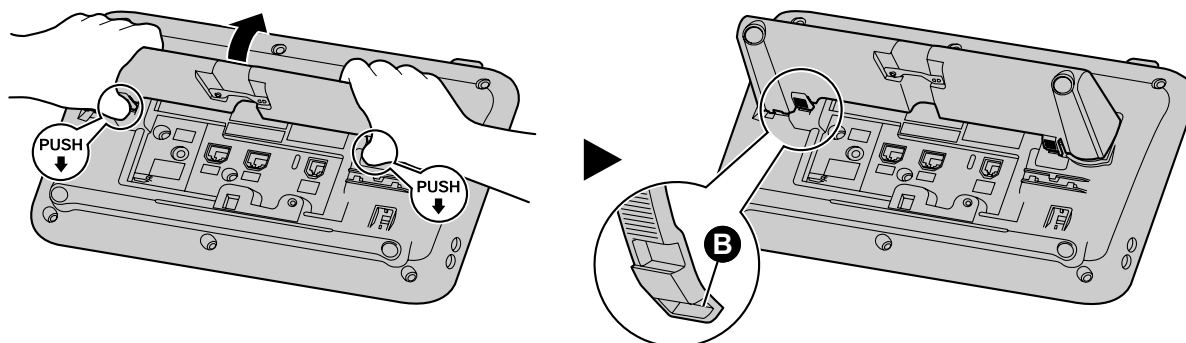

### Adjusting from Low to High Position (KX-UT133/KX-UT136/KX-UT248 only)

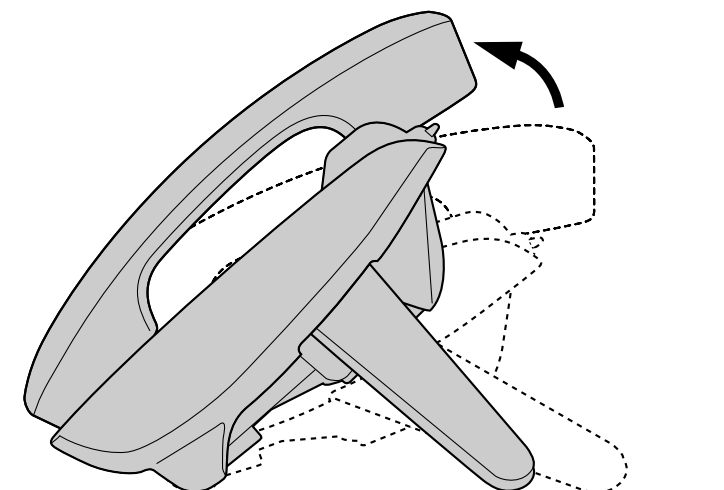

1. Tilt the stand in the direction indicated while pushing the PUSH mark with both hands as shown until it locks into the high position (A).

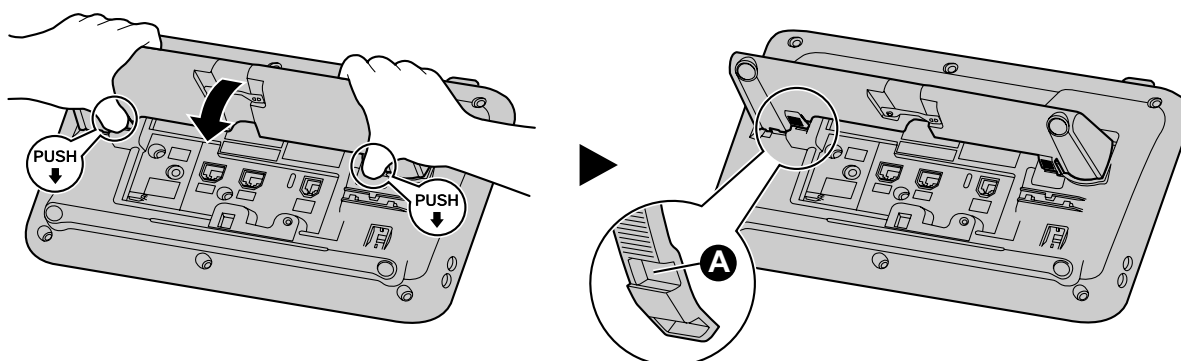

# Connections

This section explains the ports and connectors on the unit.

## Connections for AC Adaptor/LAN/PC

For KX-UT113/KX-UT123:

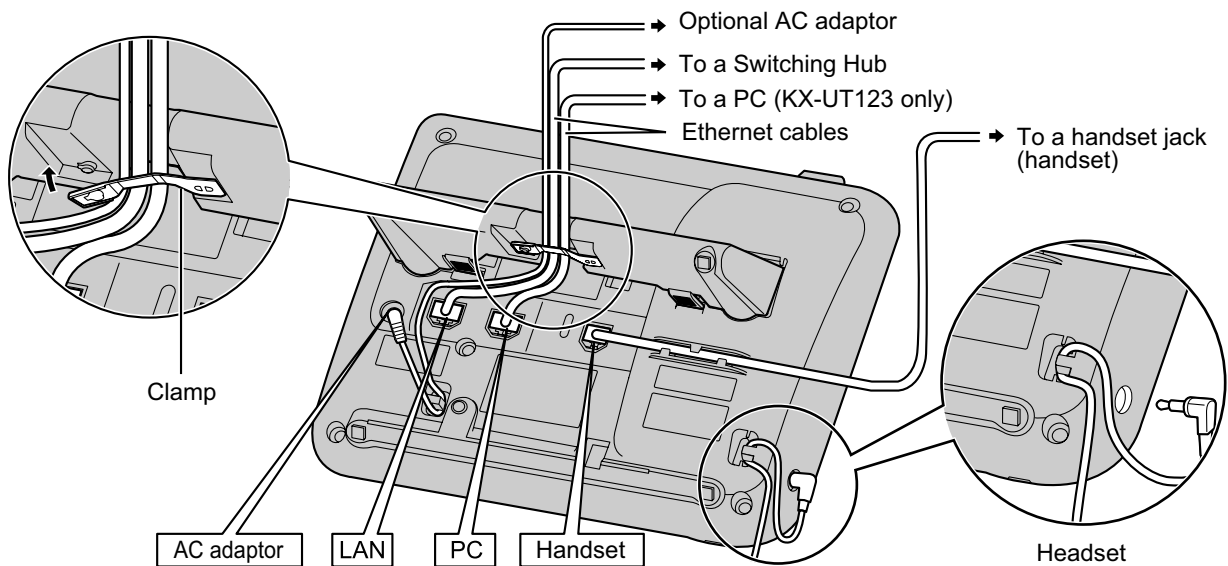

For KX-UT133/KX-UT136/KX-UT248:

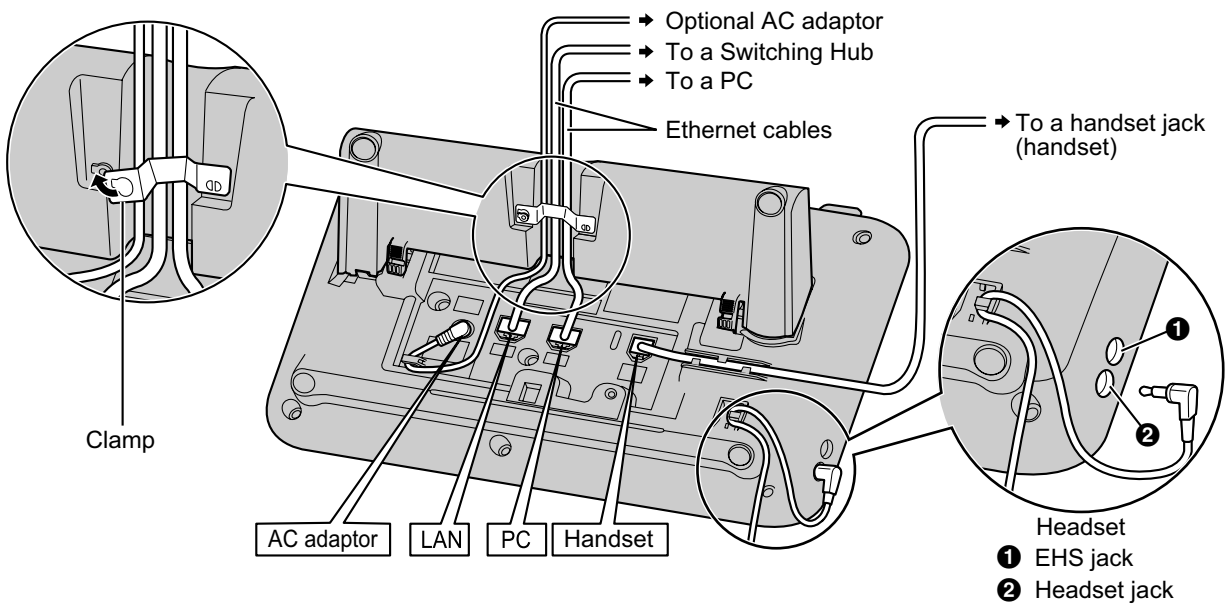

### CAUTION

#### Optional AC Adaptor

- Use the following Panasonic AC adaptor:
  - For KX-UT113X/KX-UT123X/KX-UT133X/KX-UT136X/KX-UT248X:

KX-A239AL (PQLV206AL)/KX-A239BX (PQLV206CE)/KX-A239UK (PQLV206E)/KX-A239X (PQLV206)/KX-A239EJ (PQLV206E)/KX-A420BR (PSLP1662)

- For KX-UT113NE/KX-UT123NE/KX-UT133NE/KX-UT136NE/KX-UT248NE:  
KX-A239CE (PQLV206CE)
- For KX-UT113RU/KX-UT123RU/KX-UT133RU/KX-UT136RU/KX-UT248RU:  
KX-A239BX (PQLV206CE)
- The AC adaptor is used as the main disconnect device. Ensure that the AC outlet is installed near the unit and is easily accessible.

### When connecting a headset

- Ensure that the headset cord has slack and is not pulled tight during use to prevent damage to the connectors.
- Cords used to connect devices to the EHS jack or headset jack must be less than 3 m in length.

### Notice

The following headsets can be used with this unit. (Not all operations with the headsets can be guaranteed.)

- For KX-UT113X/KX-UT123X/KX-UT133X/KX-UT136X/KX-UT248X:
  - EHS headsets (KX-UT133/KX-UT136/KX-UT248 only)  
Selected Plantronics®-brand headsets
  - Bluetooth headsets (KX-UT248 only)  
Selected Plantronics-brand headsets  
Selected GN Netcom-brand headsets
- For KX-UT113NE/KX-UT123NE/KX-UT133NE/KX-UT136NE/KX-UT248NE:
  - EHS headsets (KX-UT133/KX-UT136/KX-UT248 only)  
Selected Plantronics-brand headsets
  - Bluetooth headsets (KX-UT248 only)  
Selected Plantronics-brand headsets  
Selected GN Netcom-brand headsets
- For KX-UT113RU/KX-UT123RU/KX-UT133RU/KX-UT136RU/KX-UT248RU:
  - EHS headsets (KX-UT133/KX-UT136/KX-UT248 only)  
Selected Plantronics-brand headsets
  - Bluetooth headsets (KX-UT248 only)  
Selected Plantronics-brand headsets  
Selected GN Netcom-brand headsets

For up-to-date information about headsets that have been tested with this unit, refer to the following web sites:

<http://panasonic.net/pcc/support/sipphone>

### When selecting Ethernet cables (not included)

- Use flexible, high-quality, snagless (without strain relief) cables. Do not use cables with coating that may tear or crack when bent.  
To prevent damage to the cables, use cables that do not protrude from the bottom of the base.

Connect the cables as shown in the following illustration.

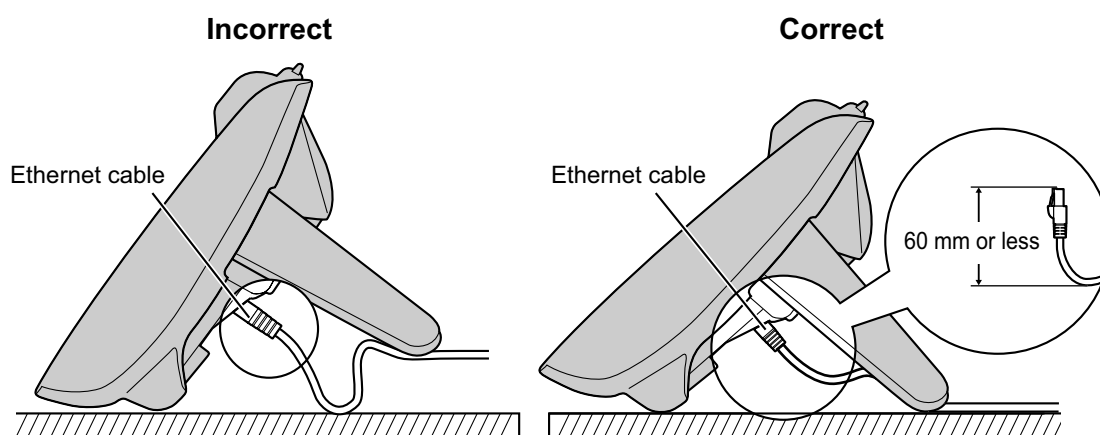

- For KX-UT113/KX-UT123/KX-UT133/KX-UT136: Use a straight CAT 5 (or higher) Ethernet cable (not included) that is 6.5 mm in diameter or less.
- For KX-UT248: Use a straight CAT 5e (or higher) Ethernet cable (not included) that is 6.5 mm in diameter or less.

#### When connecting to a switching hub

- If PoE is available, an AC adaptor is not needed.
- For KX-UT113/KX-UT123/KX-UT133/KX-UT136: This unit complies with the PoE Class 2 standard.
- For KX-UT248: This unit complies with the PoE Class 3 standard.

#### When connecting a PC

- Only a PC can be connected to the PC port. Other SIP phones, or network devices such as routers or switching hubs, cannot be connected.
- The PC port does not support PoE for connected devices.

#### When connecting cables and the AC adaptor

- Ensure that the Ethernet cables and the AC adaptor cord are clamped to prevent damage to the connectors.

#### When registering a Bluetooth headset (KX-UT248 only)

- One Bluetooth headset can be registered to this unit. For details, see "Registering the Bluetooth headset (Page 78)".

## Connections for Handset

For KX-UT113/KX-UT123:

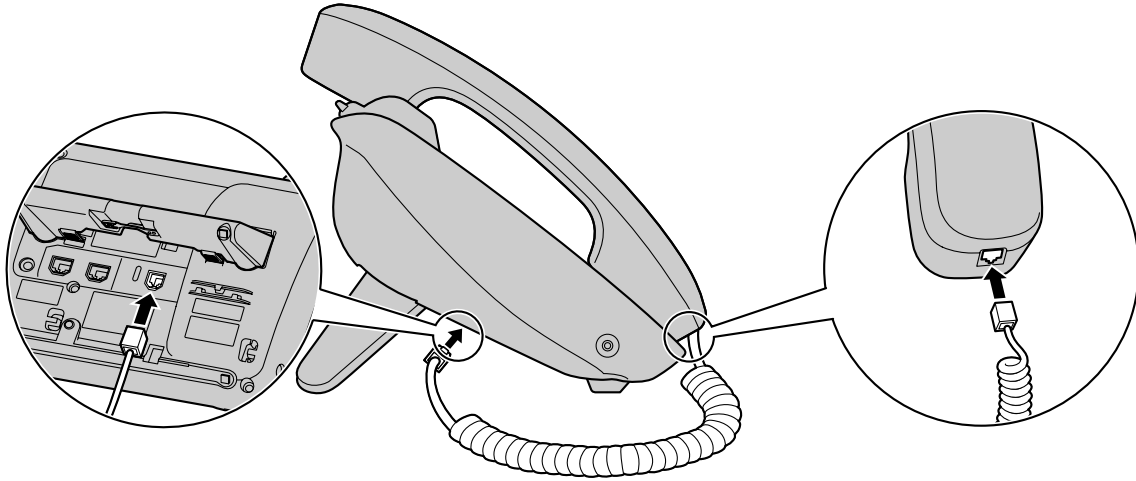

For KX-UT133/KX-UT136/KX-UT248:

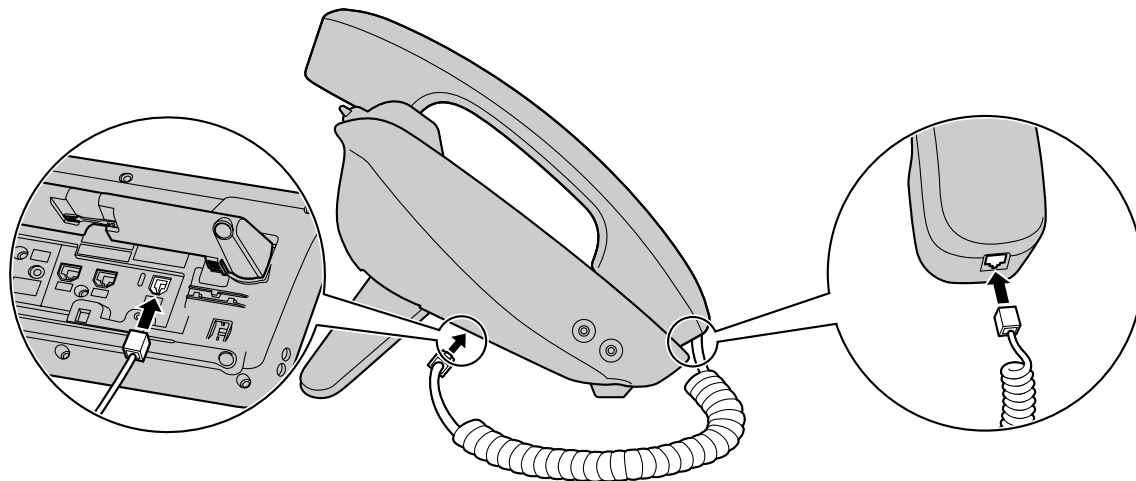

# Wall Mounting

## Before Mounting on a Wall

To mount the unit, it is necessary to remove the stand. For details, see "Removing the Stand (Page 65)".

## Mounting the Unit

### **WARNING**

- Do not mount the unit in a manner other than that described in this section.
- Make sure that the wall that the unit will be attached to is strong enough to support the unit. If not, it is necessary for the wall to be reinforced. For information about the weight of the unit, see "Specifications (Page 81)".
- Only use the optional wall mount kit with the unit. The wall mount kit includes the necessary screws, washers, and wall mounting adaptor.
- When driving the screws into the wall, be careful to avoid touching any metal laths, wire laths or metal plates in the wall.
- When this unit is no longer in use, make sure to detach it from the wall.

### **CAUTION**

- Make sure the cables are securely fastened to the wall.

### **Notice**

- If you place the display face down when you attach the wall mounting adaptor, be sure to place a soft cloth under the display before attaching the adaptor. Failure to do so may result in damage to the display.

1. Insert the 3 tabs (for KX-UT113/KX-UT123) or 5 tabs (for KX-UT133/KX-UT136/KX-UT248) of the wall mounting adaptor into the designated openings in the base, and then slide the wall mounting adaptor in the direction of the arrow until it clicks.

**For KX-UT113/KX-UT123:**

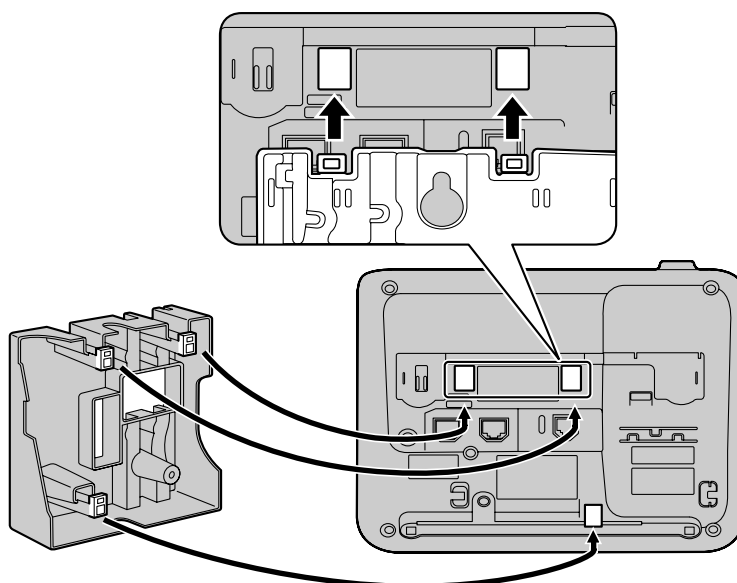

**For KX-UT133/KX-UT136/KX-UT248:**

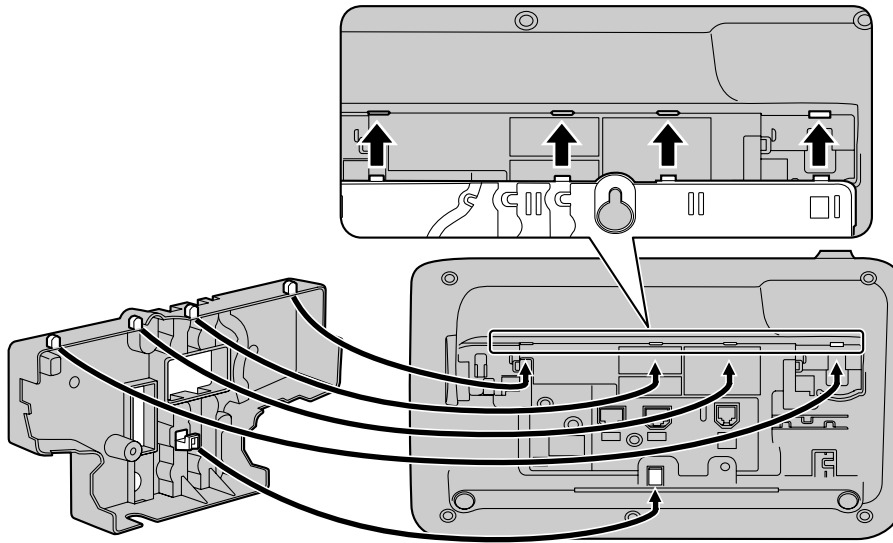

2. Fasten the wall mounting adaptor to the base with 1 screw. (Recommended torque: 0.4 N·m [4.08 kgf·cm] to 0.6 N·m [6.12 kgf·cm])

**For KX-UT113/KX-UT123:**

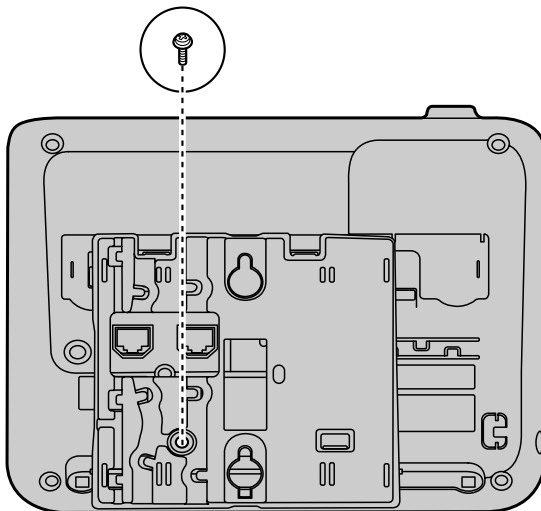



**For KX-UT133/KX-UT136/KX-UT248:**

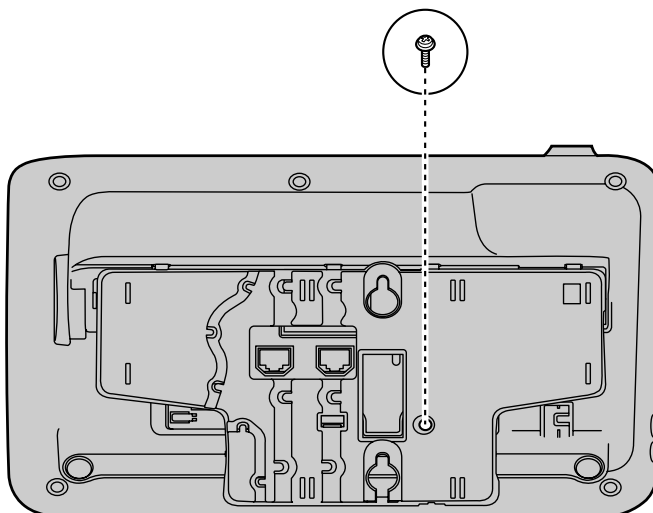

3. Connect the cables to the unit, and run the cables through the wall mounting adaptor, as shown in the illustration below.  
For details about connecting the cables, see "Connections (Page 67)".

**Note**

- The cables can also be run from the bottom of the unit.

**For KX-UT113/KX-UT123:**

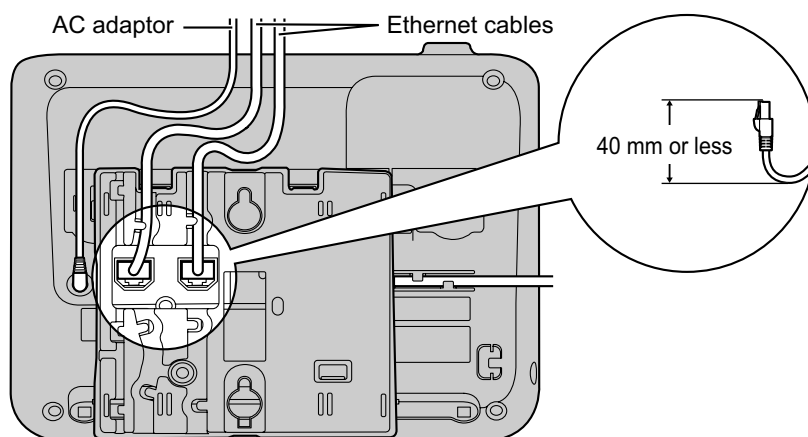

**For KX-UT133/KX-UT136/KX-UT248:**

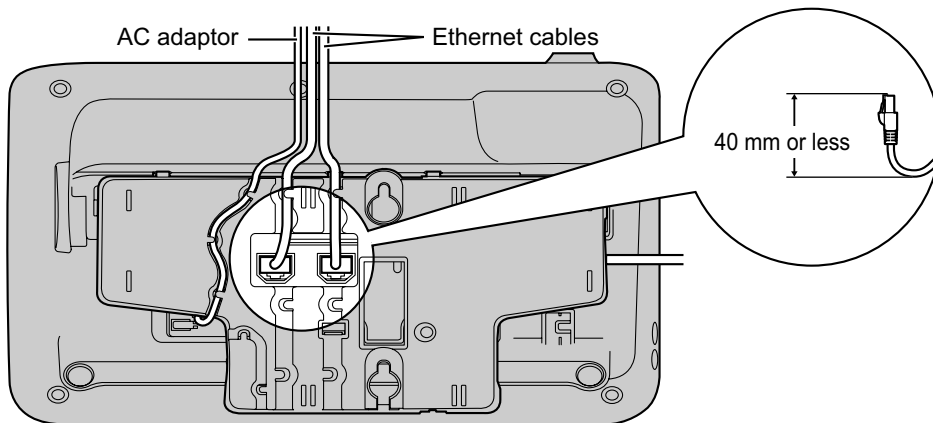

4. Drive the 2 screws into the wall either 83 mm or 100 mm apart, and mount the unit on the wall.

**For KX-UT113/KX-UT123:**

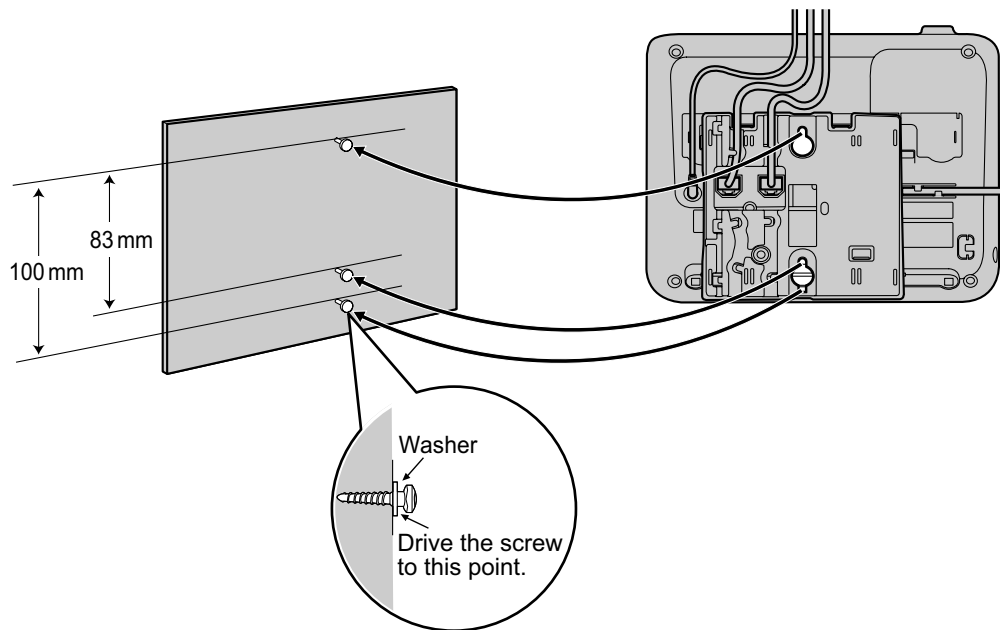

For KX-UT133/KX-UT136/KX-UT248:

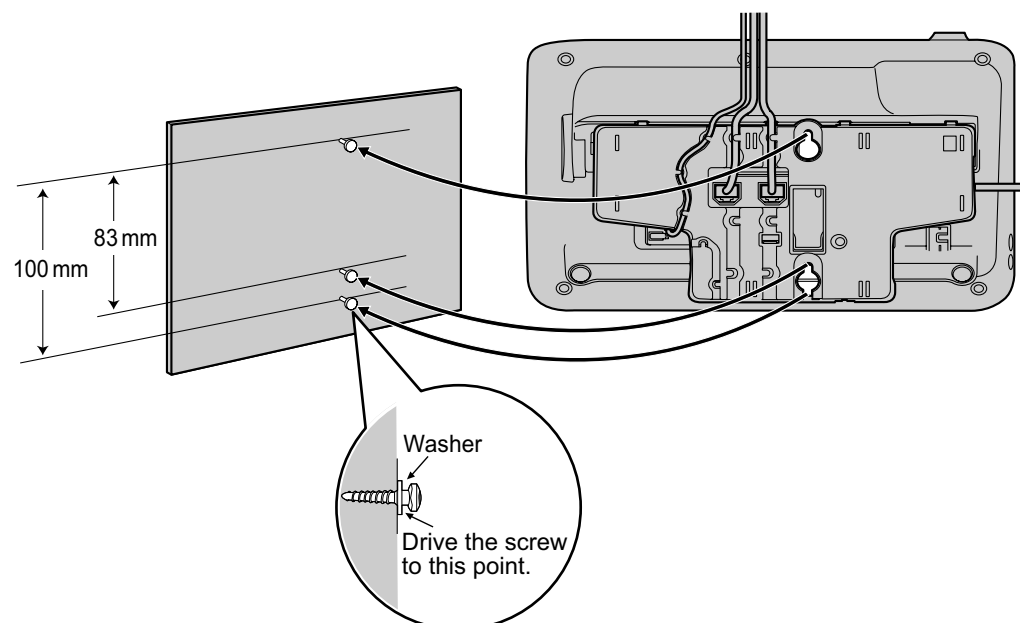

**Note**

- You can find a wall mounting template at the end of this manual.
- For information about locking the handset, see "Hooking the Handset (Page 76)".

## Hooking the Handset

You can hook the handset with following operations.

### To Hook the Handset During a Conversation

1. Hook the handset over the top edge of the unit.

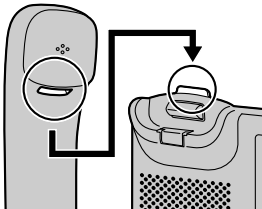

### To Lock the Handset Hook when the Unit is Wall Mounted

1. Remove the handset hook from the slot.

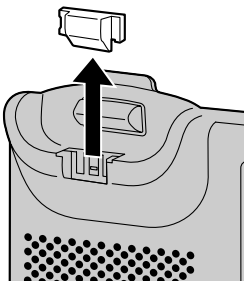

2. Turn it up-side-down.

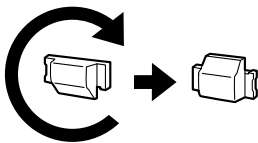

3. Slide the handset hook back into the slot until it locks.

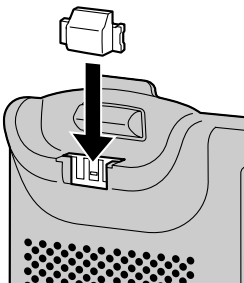

4. Handset is safely hooked when it is in the cradle.

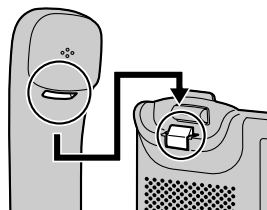

## Using a Headset

For KX-UT133/KX-UT136/KX-UT248, if a headset is connected, you must enable Headset mode using the Headset button (flexible button).

To enable Headset mode, press the Headset button (flexible button).

### Note

- For KX-UT113/KX-UT123, the Headset mode is automatically enabled when connecting a headset.
- The Headset button light shows the current status as follows:  
Off: Headset mode off  
Red on: Headset mode on
- For details about setting a flexible button as the Headset button, consult your administrator or dealer.

## For a Bluetooth Headset User (KX-UT248 only)

A KX-UT248 can be used with a Bluetooth headset. Before using the Bluetooth headset, you need to register it to the unit.

### Registering the Bluetooth headset

Set the headset to pairing mode by following the instructions in the headset's documentation.

1. In stand-by mode, press **Setting**.
2. Press **[▲]** or **[▼]** to select "Bluetooth Headset", and then press **[ENTER]**.
3. Press **[ENTER]** to select "Add new device".
4. Enter the Pass Key for your Bluetooth headset in "Enter PIN", and then press **[ENTER]**.

### Note

- For more information regarding the Pass Key, see the documentation for your headset, or consult the Bluetooth headset's manufacturer.

### Disconnecting the Bluetooth headset

1. In stand-by mode, press **Setting**.
2. Press **[▲]** or **[▼]** to select "Bluetooth Headset", and then press **[ENTER]**.
3. Press **[▲]** or **[▼]** to select "Disconnect", and then press **[ENTER]**.

### Note

-  is displayed when headset is disconnected and the unit is in stand-by mode.

### Connecting the Bluetooth headset

1. In stand-by mode, press **Setting**.
2. Press **[▲]** or **[▼]** to select "Bluetooth Headset", and then press **[ENTER]**.
3. Press **[▲]** or **[▼]** to select "Connect", and then press **[ENTER]**.

### Note

-  is displayed when headset is connected and the unit is in stand-by mode.

### Deregistering the Bluetooth headset

1. In stand-by mode, press **Setting**.
2. Press **[▲]** or **[▼]** to select "Bluetooth Headset", and then press **[ENTER]**.
3. Press **[▲]** or **[▼]** to select "Deregistration", and then press **[ENTER]**.

### Switching from your Bluetooth headset to the handset during a call

1. Lift the handset off of its cradle.

### Operating Distance

Please keep units containing Bluetooth modules 3 m or more apart from each other. Also, if a Bluetooth headset is in use near a telephone containing a Bluetooth module other than the one it is registered to, noise may be heard. To improve the signal, move away from the telephone and closer to the one it is registered to.

### Noise

Signals are transmitted between the unit and the Bluetooth headset using radio waves. For maximum distance and noise free operation, it is recommended that the unit is situated away from electrical appliances such as faxes, radios, personal computers, or microwaves.

- Systems using the 2.4 GHz ISM (Industrial, Scientific and Medical) band may interfere with this product. Examples of such systems are cordless telephones, wireless LAN, Home RF, microwave ovens and other ISM devices. These systems may cause minor noise.

### Notice

Operation is subject to the following two conditions:

1. this unit may not cause interference, and
2. this unit must accept any interference, including interference that may cause undesired operation of the unit. Privacy of communications may not be ensured when using the unit.

## Setting Up the Unit

This section explains the settings that you can configure when you start the unit.

### Accessing the start-up settings

1. Connect the unit to an Ethernet cable capable of delivering power (PoE compliant), or use an optional AC adaptor to supply power.
2. Connect the unit to the network.
3. On the start-up screen, press **Setup**.
4. Select the item for the settings you want to configure.

### Start-up menu

You can configure the following start-up settings:

1. **Information Display** (Page 49)  
View a variety of information about the unit.
2. **Network Settings** (Page 49)  
Assign an IP address in order to connect to the network and use the unit.
3. **Network Test** (Page 52)  
Confirm the connection of network devices (e.g., the SIP server, routers, switching hubs).
4. **ECO Mode** (Page 45)  
Enable ECO mode.
5. **Language** (Page 48)  
If you prefer to use a language other than English, change your language settings.
6. **Restart** (Page 52)  
Restart the unit for new settings to take effect.
7. **Firmware version** (Page 52)  
Check the firmware version of the unit.

## Maintaining the Unit

### Initialising the Unit

Doing an initialisation resets some or all settings to their default values. For details, consult your administrator or dealer.

### Restarting the Unit

When some of the settings on the unit have been changed via Web user interface programming or configuration file programming, the unit must be restarted.

1. In stand-by mode, press **Setting**.
2. Press **[▲]** or **[▼]** to select "Restart", and then press **[ENTER]**.
3. Press **[▲]** or **[▼]** to select "Yes", and then press **[ENTER]**.
  - To cancel, select "No".

### Cleaning the Unit

Clean the unit periodically by wiping it with a soft and dry cloth.



When cleaning the unit, observe the following precautions.

#### When cleaning the display

- Wipe the display with only the following types of materials:
  - A soft and dry cloth.
  - A soft cloth with very small quantity of neutral detergent or ethyl alcohol.
- Do not press or rub the display with too much force.

#### When cleaning the body

- To avoid damaging the unit, disconnect the Ethernet cable and all other cables from the unit before cleaning. If the unit is powered with an AC adaptor, disconnect the AC adaptor from the unit and power outlet before cleaning.
- If the unit becomes particularly dirty, apply a light kitchen cleanser to a soft cloth, wring the cloth thoroughly, and then wipe the unit. When finished, dry the unit with a soft and dry cloth.
- To avoid damage or discoloration, do not clean the unit with the any of following materials or with cleaners that contain any of the following materials:
  - Petroleum
  - Scouring powder
  - Alcohol
  - Paint thinner
  - Benzine
  - Wax
  - Hot water
  - Powdered soap
- When using chemical cleansers, follow the instructions on the label carefully.



# Appendix

## Specifications

For KX-UT113/KX-UT123/KX-UT133/KX-UT136

Item	Specifications			
	KX-UT113	KX-UT123	KX-UT133	KX-UT136
LCD Display	Monochrome graphical			
LCD Size	242 × 55 pixels, 3 lines			242 × 109 pixels, 6 lines
LCD Backlight	—	Always On/Automatic/Always Off		
Flexible Buttons	—		24	
VoIP Connection Method	SIP			
VoIP Audio Codec	G.722, G.711, G.729A, G.726			
Ethernet Interface	10Base-T/100Base-TX			
IP Address Mode	Automatic (DHCP), Manual (static)			
Speaker	1			
Microphone	1			
Ethernet Port (LAN)	1 (RJ45)	2 (RJ45)		
Headset Jack	1 (ø 2.5 mm)			
EHS Jack	—		1 (ø 3.5 mm, for EHS only)	
Dimensions (Width × Depth × Height; handset on cradle, stand attached)	205 mm × 160 mm × 170 mm		"High" position: 267 mm × 170 mm × 180 mm "Low" position: 267 mm × 187 mm × 155 mm	
Weight (with handset, handset cord and stand)	860 g	870 g	1120 g	
PoE	IEEE 802.3af Class 2 standard compliant			
Power Consumption	PoE Stand-by: approx. 1.8 W (ECO mode off), approx. 1.3 W (ECO mode on) Talking: approx. 2 W (ECO mode off), approx. 1.5 W (ECO mode on)  AC Adaptor Stand-by: approx. 1.6 W (ECO mode off), approx. 1 W (ECO mode on) Talking: approx. 2 W (ECO mode off), approx. 1.5 W (ECO mode on)			
Maximum Power Consumption	6 W			
Operating Environment	0 °C to 40 °C			

For KX-UT248

Item	Specifications
LCD Display	4-level greyscale graphical
LCD Size	4.4 inch
LCD Backlight	Always On/Automatic/Always Off
Flexible Buttons	24 (Three pages of eight flexible buttons are shown on the display)
VoIP Connection Method	SIP
VoIP Audio Codec	G.722, G.711, G.729A, G.726
Ethernet Interface	10Base-T/100Base-TX/1000Base-T
IP Address Mode	Automatic (DHCP), Manual (static)
Speaker	1
Microphone	1
Ethernet Port (LAN)	2 (RJ45)
Headset Jack	1 (ø 2.5 mm)
EHS Jack	1 (ø 3.5 mm, for EHS only)
Bluetooth	1 (Bluetooth wireless technology 2.0)
Dimensions (Width × Depth × Height; handset on cradle, stand attached)	"High" position: 267 mm × 170 mm × 180 mm "Low" position: 267 mm × 187 mm × 155 mm
Weight (with handset, handset cord and stand)	1130 g
PoE	IEEE 802.3af Class 3 standard compliant
Power Consumption	PoE Stand-by: approx. 3.5 W (ECO mode off), approx. 2.3 W (ECO mode on) Talking: approx. 4.1 W (ECO mode off), approx. 2.5 W (ECO mode on)  AC Adaptor Stand-by: approx. 4.0 W (ECO mode off), approx. 2.2 W (ECO mode on) Talking: approx. 4.5 W (ECO mode off), approx. 2.7 W (ECO mode on)
Maximum Power Consumption	7.5 W
Operating Environment	0 °C to 40 °C

# Troubleshooting

## Common Issues and Solutions

### General Use

Issue	Possible Cause & Solution	Reference
The display is blank.	<ul style="list-style-type: none"> <li>• The unit is not receiving power. → The unit is not designed to function when there is a power failure. Make sure that the device supplying PoE is receiving power and that the Ethernet cable is properly connected. If an AC adaptor is connected, confirm that the AC adaptor is connected and receiving power.</li> </ul>	Page 67
The display is not shown well.	<ul style="list-style-type: none"> <li>• The display's contrast is too low. → Adjust the display's contrast.</li> </ul>	Page 45
The unit is not performing properly.	<ul style="list-style-type: none"> <li>• Cables or cords are not connected properly. → Check all connections.</li> </ul>	Page 67
	<ul style="list-style-type: none"> <li>• Your connection settings are incorrect. → Consult your administrator to confirm that your settings are correct. → If the problem persists, consult your dealer.</li> </ul>	Page 42
	<ul style="list-style-type: none"> <li>• An error has occurred. → Restart the unit.</li> </ul>	Page 80
 is displayed on the screen.	<ul style="list-style-type: none"> <li>• Registration to the SIP server has been lost. → Consult your administrator or dealer.</li> </ul>	—
I cannot hear a dial tone.	<ul style="list-style-type: none"> <li>• Confirm that the LAN cable is properly connected.</li> </ul>	Page 67
I cannot cancel the display lock.	<ul style="list-style-type: none"> <li>• The PIN number you entered was incorrect. → Consult your administrator or dealer.</li> </ul>	—
I forgot my PIN number.	<ul style="list-style-type: none"> <li>• Consult your administrator or dealer.</li> </ul>	—
The date and time are not correct.	<ul style="list-style-type: none"> <li>• Adjust the date and time of the unit.</li> </ul>	Page 48
The Message/Ringer lamp is lit.	<ul style="list-style-type: none"> <li>• You received a voice message while you were on the phone or away from your desk. → Check the voice message.</li> </ul>	Page 37

## Making and Receiving Calls

Issue	Possible Cause & Solution	Reference
I cannot make calls.	<ul style="list-style-type: none"> <li>Your phone system/service has disabled service for your unit. → On the <b>Information Display</b> screen (Page 49), if "<b>Not registered</b>" is displayed in "<b>Status</b>", consult your administrator or dealer.</li> </ul>	—
	<ul style="list-style-type: none"> <li>The phone number was entered incorrectly. → Confirm that you have entered the phone number of the other party correctly. → Consult your administrator or dealer.</li> </ul>	Page 29
	<ul style="list-style-type: none"> <li>The unit is downloading a firmware update. → You cannot make calls while the unit is downloading updates. Wait for the update to finish, and then try making a call.</li> </ul>	—
	<ul style="list-style-type: none"> <li>The phonebook list is being imported or exported. → Wait a few minutes for the operation to complete. → Confirm with your administrator or dealer.</li> </ul>	—
I cannot make long distance calls.	<ul style="list-style-type: none"> <li>Your telephone service does not allow you to make long distance calls. → Make sure that you have subscribed to your telephone company's long distance service.</li> </ul>	—
The unit does not ring when a call is received.	<ul style="list-style-type: none"> <li>The ringer is turned off. → Press <b>[▲]</b> while a call is being received, or change the ringer volume setting.</li> </ul>	Page 45
While talking to an outside party, the line is disconnected.	<ul style="list-style-type: none"> <li>Your phone system/service may impose a time limit on outside calls. → Consult your dealer to extend the time limit, if necessary.</li> </ul>	—

## Sound Quality

Issue	Possible Cause & Solution	Reference
The other party cannot hear my voice.	<ul style="list-style-type: none"> <li>The unit is muted. → Press <b>[MUTE/🔇]</b> to turn off the mute feature.</li> </ul>	Page 35
	<ul style="list-style-type: none"> <li>If you are using the speakerphone, objects may be obstructing the microphone. → Do not obstruct the unit's microphone during calls. Keep your hands, as well as common objects such as folders, cups, and coffee pots away from the unit during calls.</li> </ul>	—

Issue	Possible Cause & Solution	Reference
Sound cuts out; I can hear myself through the speaker.	<ul style="list-style-type: none"> <li>You are too far away from the microphone. → Try speaking closer to the microphone.</li> </ul>	—
	<ul style="list-style-type: none"> <li>The environment is not suited to speakerphone calls. → Do not use the unit within 2 m of projectors, air conditioning devices, fans, or other audible or electrical noise emitting devices. → If using the unit in a room with windows, close the curtains or blinds to prevent echoes. → Use the unit in a quiet environment.</li> </ul>	—
	<ul style="list-style-type: none"> <li>The unit was moved during a call. → Do not move the unit while on a call.</li> </ul>	—
	<ul style="list-style-type: none"> <li>Objects are obstructing the microphone. → Do not obstruct the unit during calls. Keep your hands, as well as common objects such as folders, cups, and coffee pots away from the unit during calls.</li> </ul>	—
	<ul style="list-style-type: none"> <li>The other party is using a half-duplex speakerphone. → If the other party is using a half-duplex speakerphone, sound may cut out occasionally during calls. For best performance, the other party should use a full-duplex speakerphone.</li> </ul>	—
	<p>&lt;KX-UT248 only&gt;</p> <ul style="list-style-type: none"> <li>Just after a call begins, the unit may not have yet adjusted itself to the call's environment. → Just after a call begins, take turns with the other party talking to each other. The unit will adjust itself in accordance with the call environment so that both you and the other party can hear each other as clearly as possible.</li> </ul>	—

## Phonebook List

Issue	Possible Cause & Solution	Reference
I cannot add or edit entries to the phonebook list.	<ul style="list-style-type: none"> <li>The phonebook list is full. → Delete any unnecessary entries. The maximum number of entries in the phonebook list is 500 for the KX-UT123/KX-UT133/KX-UT136/KX-UT248 and 100 for the KX-UT113.</li> </ul>	Page 40

## Bluetooth Headset (KX-UT248 only)

Issue	Possible Cause & Solution	Reference
I cannot have a conversation using the Bluetooth headset.	<ul style="list-style-type: none"><li>• Make sure that the headset is properly registered to the unit.</li><li>• Make sure that the headset is properly charged by following the instructions in the headset's documentation.</li><li>• Remove the wired headset from the headset jack. Priority is given to the wired headset when both are connected.</li></ul>	—

## Error Messages

During operation, error messages might appear on the unit. The following table lists these messages and possible causes and solutions.

Message	Possible Cause & Solution	Reference
IP address collision	<ul style="list-style-type: none"> <li>The unit's network settings are incorrect. → Consult your system administrator or dealer.</li> </ul>	—
Illegal IP address		
Invalid IP address		
Check LAN cable.	<ul style="list-style-type: none"> <li>The LAN cable is not connected. → Check all connections.</li> </ul>	Page 67
Memory Full	<ul style="list-style-type: none"> <li>A new entry for the phonebook or call block list cannot be stored because the phonebook or call block list is full. → Delete unneeded entries.</li> </ul>	Page 41
No Entries	<ul style="list-style-type: none"> <li>The phonebook or call block list contains no entries. → Store entries in the phonebook or call block list.</li> </ul>	Page 40 Page 32
Please wait...	<ul style="list-style-type: none"> <li>The unit is still starting up. → If you have a lot of entries in the phonebook list, the unit may take a while to start up. This is normal.</li> </ul>	—

## Revision History

### **KX-UT113/KX-UT123/KX-UT133/KX-UT136 Software File Version 01.025**

#### **Changed Contents**

- Removing a Party from the Conference (Page 36)
- Ringer (Page 45)
- Initialising the Unit (Page 80)



## **KX-UT113/KX-UT123/KX-UT133/KX-UT136 Software File Version 01.080**

### **New Contents**

- Key Click Tone (Page 46)

### **Changed Contents**

- Dialling by Using Call Logs (Page 30)
- Rejecting Calls (Page 31)
- Transferring a Call (Call Transfer) (Page 34)
- Checking Missed Calls (Page 37)
- Adding a Phonebook Entry from the Incoming or Missed Call Log (Page 40)

## **KX-UT113/KX-UT123/KX-UT133/KX-UT136/KX-UT248 Software File Version 01.160**

### **Changed Contents**

- Logging in to or Logging out of a Group (KX-UT133/KX-UT136/KX-UT248 only) (Page 38)
- Flexible Buttons (KX-UT133/KX-UT136/KX-UT248 only) (Page 39)
- Available Settings (Page 43)
- Settings Details (Page 45)

## **KX-UT113/KX-UT123/KX-UT133/KX-UT136/KX-UT248 Software File Version 01.250**

### **New Contents**

- Erasing All Call Logs (Page 37)

### **Changed Contents**

- Available Settings (Page 43)
- Network Settings (Page 49)

# Open Source Software

Parts of this product use Open Source Software. Relevant conditions apply to this software. Panasonic cannot accept inquiries regarding the content of the following copyright and licence information.

<<NetBSD kernel>>

This product uses a part of NetBSD kernel.

The use of a part of NetBSD kernel is based on the typical BSD style license below.

Copyright (c)

The Regents of the University of California. All rights reserved.

Redistribution and use in source and binary forms, with or without modification, are permitted provided that the following conditions are met:

1. Redistributions of source code must retain the above copyright notice, this list of conditions and the following disclaimer.
2. Redistributions in binary form must reproduce the above copyright notice, this list of conditions and the following disclaimer in the documentation and/or other materials provided with the distribution.
3. All advertising materials mentioning features or use of this software must display the following acknowledgement:  
This product includes software developed by the University of California, Berkeley and its contributors.
4. Neither the name of the University nor the names of its contributors may be used to endorse or promote products derived from this software without specific prior written permission.

THIS SOFTWARE IS PROVIDED BY THE REGENTS AND CONTRIBUTORS "AS IS" AND ANY EXPRESS OR IMPLIED WARRANTIES, INCLUDING, BUT NOT LIMITED TO, THE IMPLIED WARRANTIES OF MERCHANTABILITY AND FITNESS FOR A PARTICULAR PURPOSE ARE DISCLAIMED. IN NO EVENT SHALL THE REGENTS OR CONTRIBUTORS BE LIABLE FOR ANY DIRECT, INDIRECT, INCIDENTAL, SPECIAL, EXEMPLARY, OR CONSEQUENTIAL DAMAGES (INCLUDING, BUT NOT LIMITED TO, PROCUREMENT OF SUBSTITUTE GOODS OR SERVICES; LOSS OF USE, DATA, OR PROFITS; OR BUSINESS INTERRUPTION) HOWEVER CAUSED AND ON ANY THEORY OF LIABILITY, WHETHER IN CONTRACT, STRICT LIABILITY, OR TORT (INCLUDING NEGLIGENCE OR OTHERWISE) ARISING IN ANY WAY OUT OF THE USE OF THIS SOFTWARE, EVEN IF ADVISED OF THE POSSIBILITY OF SUCH DAMAGE.

However, parts of the NetBSD Kernel are provided with the following copyright notices.

Copyright (c) 1980, 1983, 1988, 1993 The Regents of the University of California. All rights reserved.  
 Copyright (c) 1980, 1986, 1989, 1993 The Regents of the University of California. All rights reserved.  
 Copyright (c) 1980, 1986, 1991, 1993 The Regents of the University of California. All rights reserved.  
 Copyright (c) 1980, 1986, 1993 The Regents of the University of California. All rights reserved.  
 Copyright (c) 1982, 1985, 1986, 1988, 1993, 1994 The Regents of the University of California. All rights reserved.  
 Copyright (c) 1982, 1986, 1988, 1990, 1993 The Regents of the University of California. All rights reserved.  
 Copyright (c) 1982, 1986, 1988, 1990, 1993, 1994, 1995 The Regents of the University of California. All rights reserved.  
 Copyright (c) 1982, 1986, 1988, 1990, 1993, 1995 The Regents of the University of California. All rights reserved.  
 Copyright (c) 1982, 1986, 1988, 1991, 1993 The Regents of the University of California. All rights reserved.  
 Copyright (c) 1982, 1986, 1988, 1993 The Regents of the University of California. All rights reserved.  
 Copyright (c) 1982, 1986, 1988, 1993, 1995 The Regents of the University of California. All rights reserved.  
 Copyright (c) 1982, 1986, 1989, 1991, 1993 The Regents of the University of California. All rights reserved.  
 Copyright (c) 1982, 1986, 1989, 1993 The Regents of the University of California. All rights reserved.  
 Copyright (c) 1982, 1986, 1990, 1991, 1993 The Regents of the University of California. All rights reserved.  
 Copyright (c) 1982, 1986, 1990, 1993 The Regents of the University of California. All rights reserved.  
 Copyright (c) 1982, 1986, 1990, 1993, 1994 The Regents of the University of California. All rights reserved.  
 Copyright (c) 1982, 1986, 1991, 1993 The Regents of the University of California. All rights reserved.  
 Copyright (c) 1982, 1986, 1991, 1993, 1994 The Regents of the University of California. All rights reserved.  
 Copyright (c) 1982, 1986, 1991, 1993, 1995 The Regents of the University of California. All rights reserved.  
 Copyright (c) 1982, 1986, 1993 The Regents of the University of California. All rights reserved.  
 Copyright (c) 1982, 1986, 1993, 1994 The Regents of the University of California. All rights reserved.  
 Copyright (c) 1982, 1986, 1993, 1994, 1995 The Regents of the University of California. All rights reserved.

Copyright (c) 1982, 1986, 1993, 1995 The Regents of the University of California. All rights reserved.  
Copyright (c) 1982, 1988, 1991, 1993 The Regents of the University of California. All rights reserved.  
Copyright (c) 1983, 1990, 1993 The Regents of the University of California. All rights reserved.  
Copyright (c) 1983, 1993 The Regents of the University of California. All rights reserved.  
Copyright (c) 1985, 1986, 1993 The Regents of the University of California. All rights reserved.  
Copyright (c) 1985, 1986, 1993 The Regents of the University of California. All rights reserved.  
Copyright (c) 1986, 1989, 1991, 1993 The Regents of the University of California. All rights reserved.  
Copyright (c) 1986, 1993 The Regents of the University of California. All rights reserved.  
Copyright (c) 1987, 1991, 1993 The Regents of the University of California. All rights reserved.  
Copyright (c) 1987, 1993 The Regents of the University of California. All rights reserved.  
Copyright (c) 1987, 1993 The Regents of the University of California. All rights reserved.  
Copyright (c) 1988 Regents of the University of California. All rights reserved  
Copyright (c) 1988 Stephen Deering.  
Copyright (c) 1988 University of Utah.  
Copyright (c) 1988, 1989, 1993 The Regents of the University of California. All rights reserved.  
Copyright (c) 1988, 1991, 1993 The Regents of the University of California. All rights reserved.  
Copyright (c) 1988, 1992, 1993 The Regents of the University of California. All rights reserved.  
Copyright (c) 1988, 1993 The Regents of the University of California. All rights reserved.  
Copyright (c) 1989 The Regents of the University of California. All rights reserved.  
Copyright (c) 1989, 1991, 1993 The Regents of the University of California. All rights reserved.  
Copyright (c) 1989, 1993 The Regents of the University of California. All rights reserved.  
Copyright (c) 1989, 1993, 1994 The Regents of the University of California. All rights reserved.  
Copyright (c) 1990, 1991, 1993 The Regents of the University of California. All rights reserved.  
Copyright (c) 1990, 1993 The Regents of the University of California. All rights reserved.  
Copyright (c) 1991, 1993 The Regents of the University of California. All rights reserved.  
Copyright (c) 1991, 1993, 1994 The Regents of the University of California. All rights reserved.  
Copyright (c) 1992 Regents of the University of California. All rights reserved.  
Copyright (c) 1992, 1993 The Regents of the University of California. All rights reserved.  
Copyright (c) 1993 The Regents of the University of California. All rights reserved.  
Copyright (c) 1993 Adam Glass  
Copyright (C) 1993 by Sun Microsystems, Inc. All rights reserved.  
Copyright (c) 1994 Gordon W. Ross  
Copyright (c) 1994 Winning Strategies, Inc. All rights reserved.  
Copyright (c) 1995 The Regents of the University of California. All rights reserved.  
Copyright (C) 1995, 1996, 1997, and 1998 WIDE Project. All rights reserved.  
Copyright (c) 1996 The Regents of the University of California. All rights reserved.  
Copyright (c) 1996 John S. Dyson All rights reserved.  
Copyright (c) 1996 Matt Thomas. All rights reserved.  
Copyright (c) 1996 Matthew R. Green. All rights reserved.  
Copyright (c) 1996 Paul Kranenburg  
Copyright (c) 1996, 1997, 1999, 2001 The NetBSD Foundation, Inc. All rights reserved.  
Copyright (c) 1996, 2000 Christopher G. Demetriou. All rights reserved.  
Copyright (c) 1996,1999 by Internet Software Consortium.  
Copyright (c) 1996-1999 by Internet Software Consortium.  
Copyright (c) 1997 Jonathan Stone and Jason R. Thorpe. All rights reserved.  
Copyright (c) 1997 Christos Zoulas. All rights reserved.  
Copyright (c) 1997 Manuel Bouyer. All rights reserved.  
Copyright (c) 1997, 1998 The NetBSD Foundation, Inc. All rights reserved.  
Copyright (c) 1997, 1998, 1999, 2000 The NetBSD Foundation, Inc. All rights reserved.  
Copyright (c) 1997, 1998, 1999, 2001 The NetBSD Foundation, Inc. All rights reserved.  
Copyright (c) 1997, 1998, 1999, 2002 The NetBSD Foundation, Inc. All rights reserved.  
Copyright (c) 1997, 1998, 2000, 2001 The NetBSD Foundation, Inc. All rights reserved.  
Copyright (c) 1997, 1998, 2001 The NetBSD Foundation, Inc. All rights reserved.  
Copyright (c) 1997,98 The NetBSD Foundation, Inc. All rights reserved.  
Copyright (C) 1997-2000 Sony Computer Science Laboratories Inc. All rights reserved.  
Copyright (c) 1997-2002 The NetBSD Foundation, Inc. All rights reserved.  
Copyright (c) 1998 The NetBSD Foundation, Inc. All rights reserved.  
Copyright (c) 1998 Todd C. Miller <Todd.Miller@courtesan.com> All rights reserved.  
Copyright (c) 1998, 1999 The NetBSD Foundation, Inc. All rights reserved.  
Copyright (c) 1998, 1999, 2000 The NetBSD Foundation, Inc. All rights reserved.  
Copyright (c) 1998, 1999, 2000, 2001 The NetBSD Foundation, Inc. All rights reserved.  
Copyright (c) 1998, 2000 The NetBSD Foundation, Inc. All rights reserved.  
Copyright (c) 1998, 2000, 2001 The NetBSD Foundation, Inc. All rights reserved.  
Copyright (c) 1999 The NetBSD Foundation, Inc. All rights reserved.  
Copyright (C) 1999 WIDE Project. All rights reserved.

Copyright (c) 1999, 2000 Jason L. Wright (jason@thought.net) All rights reserved.  
 Copyright (c) 1999, 2000 The NetBSD Foundation, Inc. All rights reserved.  
 Copyright (c) 1999, 2000, 2001 The NetBSD Foundation, Inc. All rights reserved.  
 Copyright (c) 1999, 2001 The NetBSD Foundation, Inc. All rights reserved.  
 Copyright (c) 2000 The NetBSD Foundation, Inc. All rights reserved.  
 Copyright (c) 2000, 2001 The NetBSD Foundation, Inc. All rights reserved.  
 Copyright (c) 2000, 2001, 2002 The NetBSD Foundation, Inc. All rights reserved.  
 Copyright (c) 2001 The NetBSD Foundation, Inc. All rights reserved.  
 Copyright (c) 2002 The NetBSD Foundation, Inc. All rights reserved.  
 Copyright 1998 Massachusetts Institute of Technology. All rights reserved.  
 Copyright 2001 Wasabi Systems, Inc. All rights reserved.  
 Portions Copyright (c) 1993 by Digital Equipment Corporation.  
 Portions Copyright (c) 1995 by International Business Machines, Inc.  
 Copyright (c) 1983, 1989 The Regents of the University of California. All rights reserved.  
 Copyright (c) 1996 by Internet Software Consortium. All rights reserved.  
 Copyright (c) 1980, 1986, 1989 Regents of the University of California. All rights reserved.  
 Copyright (c) 1988 The Regents of the University of California. All rights reserved.  
 Copyright (c) 1992, 1993 The Regents of the University of California. All rights reserved.  
 Copyright (c) 1994 Christopher G. Demetriou. All rights reserved.  
 Copyright (c) 1997 The NetBSD Foundation, Inc. All rights reserved.  
 Copyright (c) 1999 The NetBSD Foundation, Inc. All rights reserved.  
 Copyright (c) 2001 The NetBSD Foundation, Inc. All rights reserved.  
 Copyright (c) 1996 Gardner Buchanan <gbuchanan@shl.com> All rights reserved.

Parts of the NetBSD Kernel are provided with the licenses that are slightly different from the above Berkeley-formed license. Please refer the source code of the NetBSD Kernel about the details. The source code of the NetBSD Kernel is provided by the NetBSD CVS Repositories (<http://cvsweb.netbsd.org/bsdweb.cgi/>), and this product includes parts of the source code in the following directories.

<http://cvsweb.netbsd.org/bsdweb.cgi/src/sys/kern/>  
<http://cvsweb.netbsd.org/bsdweb.cgi/src/sys/net/>  
<http://cvsweb.netbsd.org/bsdweb.cgi/src/sys/netinet/>

<<MD5>>

This software uses the Source Code of RSA Data Security, Inc. described in the RFC1321 (MD5 Message-Digest Algorithm).

-----  
 Copyright (C) 1991-2, RSA Data Security, Inc. Created 1991. All rights reserved.

License to copy and use this software is granted provided that it is identified as the "RSA Data Security, Inc. MD5 Message-Digest Algorithm" in all material mentioning or referencing this software or this function.

License is also granted to make and use derivative works provided that such works are identified as "derived from the RSA Data Security, Inc. MD5 Message-Digest Algorithm" in all material mentioning or referencing the derived work.

RSA Data Security, Inc. makes no representations concerning either the merchantability of this software or the suitability of this software for any particular purpose. It is provided "as is" without express or implied warranty of any kind.

These notices must be retained in any copies of any part of this documentation and/or software.

-----  
 <<MT19937>>

The MT19937 software that Takuji Nishimura and Makoto Matsumoto developed is contained, and this product shall be used subject to the following license conditions.

Copyright (C) 1997 - 2002, Makoto Matsumoto and Takuji Nishimura, All rights reserved.

Redistribution and use in source and binary forms, with or without modification, are permitted provided that the following conditions are met:

## Open Source Software

---

1. Redistributions of source code must retain the above copyright notice, this list of conditions and the following disclaimer.
2. Redistributions in binary form must reproduce the above copyright notice, this list of conditions and the following disclaimer in the documentation and/or other materials provided with the distribution.
3. The names of its contributors may not be used to endorse or promote products derived from this software without specific prior written permission.

THIS SOFTWARE IS PROVIDED BY THE COPYRIGHT HOLDERS AND CONTRIBUTORS "AS IS" AND ANY EXPRESS OR IMPLIED WARRANTIES, INCLUDING, BUT NOT LIMITED TO, THE IMPLIED WARRANTIES OF MERCHANTABILITY AND FITNESS FOR A PARTICULAR PURPOSE ARE DISCLAIMED. IN NO EVENT SHALL THE COPYRIGHT OWNER OR CONTRIBUTORS BE LIABLE FOR ANY DIRECT, INDIRECT, INCIDENTAL, SPECIAL, EXEMPLARY, OR CONSEQUENTIAL DAMAGES (INCLUDING, BUT NOT LIMITED TO, PROCUREMENT OF SUBSTITUTE GOODS OR SERVICES; LOSS OF USE, DATA, OR PROFITS; OR BUSINESS INTERRUPTION) HOWEVER CAUSED AND ON ANY THEORY OF LIABILITY, WHETHER IN CONTRACT, STRICT LIABILITY, OR TORT (INCLUDING NEGLIGENCE OR OTHERWISE) ARISING IN ANY WAY OUT OF THE USE OF THIS SOFTWARE, EVEN IF ADVISED OF THE POSSIBILITY OF SUCH DAMAGE.

<<thttpd>>

The thttpd software that ACME Labs developed is contained, and this product shall be used subject to the following license conditions.

Copyright 1995,1998,1999,2000 by Jef Poskanzer <jef@acme.com>.  
All rights reserved.

Redistribution and use in source and binary forms, with or without modification, are permitted provided that the following conditions are met:

1. Redistributions of source code must retain the above copyright notice, this list of conditions and the following disclaimer.
2. Redistributions in binary form must reproduce the above copyright notice, this list of conditions and the following disclaimer in the documentation and/or other materials provided with the distribution.

THIS SOFTWARE IS PROVIDED BY THE AUTHOR AND CONTRIBUTORS "AS IS" AND ANY EXPRESS OR IMPLIED WARRANTIES, INCLUDING, BUT NOT LIMITED TO, THE IMPLIED WARRANTIES OF MERCHANTABILITY AND FITNESS FOR A PARTICULAR PURPOSE ARE DISCLAIMED. IN NO EVENT SHALL THE AUTHOR OR CONTRIBUTORS BE LIABLE FOR ANY DIRECT, INDIRECT, INCIDENTAL, SPECIAL, EXEMPLARY, OR CONSEQUENTIAL DAMAGES (INCLUDING, BUT NOT LIMITED TO, PROCUREMENT OF SUBSTITUTE GOODS OR SERVICES; LOSS OF USE, DATA, OR PROFITS; OR BUSINESS INTERRUPTION) HOWEVER CAUSED AND ON ANY THEORY OF LIABILITY, WHETHER IN CONTRACT, STRICT LIABILITY, OR TORT (INCLUDING NEGLIGENCE OR OTHERWISE) ARISING IN ANY WAY OUT OF THE USE OF THIS SOFTWARE, EVEN IF ADVISED OF THE POSSIBILITY OF SUCH DAMAGE.

# Index

## A

AC adaptor 12  
 Connection 67  
 Accessories 12  
 ACD flexible button 39  
 ACD Group 38  
 Add new device (setting) 54  
 Authentication (setting) 51  
 Auto answer 31  
 AUTO ANSWER/MUTE button 19  
 Automatic Call Distribution → ACD 38

## B

Backlight (setting) 46  
 BLF flexible button 39  
 Bluetooth Headset 68  
 Bluetooth Headset (setting) 54  
 Busy Lamp Field → BLF 39

## C

Call Block (setting) 53  
 Call Forwarding 38  
 Call Logs, Erasing 37  
 Call Splitting 34  
 Call Transfer 34  
 Call Waiting 33  
 Calls  
 From call logs 30  
 From phonebook list 29  
 Holding 33  
 Making 29  
 Missed 37  
 Receiving 31  
 Redialling 30  
 Rejecting 31  
 CANCEL button 19  
 Character entry 55  
 Cleaning 80  
 CONF (Conference) button 19  
 CONFERENCE button 19  
 Conference call 36  
 Connect (setting) 54  
 Connections 67  
 Controls 13  
 Bottom view 21  
 Front View 13  
 Left view 20

## D

Date and Time (setting) 48  
 DC jack 21  
 Default Gateway (setting) 50  
 Deregistration (setting) 54  
 Dialling 29  
 Directory Number → DN 39  
 Disconnect (setting) 54

Display 18  
 Contrast 45  
 Display Lock (setting) 46  
 Display of Assigned Flexible Buttons 24  
 DN flexible button 39  
 DNS (setting) 50  
 DNS1 (setting) 50  
 DNS2 (setting) 50  
 Do Not Disturb 38  
 Do Not Disturb (setting) 46

## E

ECO Mode (setting) 45  
 EHS headsets 68  
 EHS jack 20  
 Electronic Hook Switch → EHS 68  
 Embedded web (setting) 51  
 Enable VLAN (setting) 51  
 ENTER key 19  
 Enter PIN (setting) 54  
 Error messages 87  
 Extension number 27

## F

Firmware version (setting) 52  
 FLASH/RECALL button 19  
 Flexible buttons 19, 39  
 FORWARD/DO NOT DISTURB button 19  
 Forwarding 38  
 FWD All (setting) 47  
 FWD Busy (setting) 47  
 FWD No Ans (setting) 47

## G

Group, Login/Logout 38

## H

Handset 12  
 Connections 70  
 Hooking 76  
 Volume 28  
 Handset cord 12  
 Handset hook 19  
 Handset jack 22  
 Hands-free mode 27  
 Headset 68  
 Flexible button 39  
 Using 78  
 Volume 28  
 HEADSET button 19  
 Headset jack 20  
 Hold 33  
 HOLD button 19

## I

ID (setting) 51  
 Information Display (setting) 49  
 Initialise 80  
 Installation 64

## Index

---

IP Address (setting) 50  
IP Phone (setting) 51

## K

Key Click Tone (setting) 46

## L

LAN connection 67  
LAN port 22  
LAN port (setting) 51  
Language (setting) 48  
Last Number Redial 30  
LCD (Liquid Crystal Display) 18  
LCD Contrast (setting) 45  
LLDP-MED (setting) 50  
Local Three-way Conference 36  
Login (to a Group) 38  
Logout (from a Group) 38

## M

Maintenance 80  
Making calls 29  
    Calling 29  
MESSAGE button 19  
Message/Ringer Lamp 19  
Messages, checking 37  
MIC 19  
Missed calls 37  
MUTE/AUTO ANSWER button 19

## N

Navigator key 19  
Network (setting) 49  
Network Test (setting) 52

## O

Off-hook monitor 27  
On/Off (setting) 50  
One-touch Dialling 30  
One-Touch flexible button 39  
One-touch Transfer 34

## P

Page keys 19  
Password (setting) 51  
PC (setting) 51  
PC connection 67  
PC port 22  
PC port (setting) 50, 51  
Phonebook list  
    Adding 40  
    Deleting 41  
    Editing 40  
    Export 41  
    Import 41  
    Searching 29, 41  
Priority (setting) 50, 51  
Programming, web user interface 63

## R

Receiving calls 31  
Redial 30  
REDIAL button 19  
Rejecting calls 31  
Restart 80  
Restart (setting) 52  
Ring count (setting) 47  
Ringer  
    Volume setting 28  
Ringer (setting) 45  
Ringer Volume (setting) 45  
Ringer/Message Lamp 19  
Ringtone (setting) 45

## S

Scroll indicator 24  
Search, phonebook list 29  
Settings 42  
    Accessing 42  
    Setup 64  
        Initial settings 79  
Soft buttons 19, 25  
    Icons 24, 25  
Speaker  
    Volume 28  
Speakerphone (SP-PHONE) button 19  
Specifications 81  
Speed/Duplex (setting) 51  
SP-PHONE (Speakerphone) button 19  
Stand 12  
    Adjusting 65  
    Attaching 64  
    Removing 65  
Start-up menu 79  
Status icons 23, 24  
Subnet mask (setting) 50

## T

Three-way conference 36  
Timer (setting) 50  
Transfer 34  
TRANSFER button 19  
Troubleshooting 83

## U

User settings 42

## V

VLAN (setting) 50  
VLAN ID (setting) 50, 51  
Volume 28

## W

Wall mount kit 12  
Wall mounting 71  
Web user interface programming 63  
Wrap Up 39



### WALL MOUNTING TEMPLATE

1. Drive the screws into the wall as indicated.
2. Hook the unit onto the screw heads.

**Note:**

Make sure to set the print size to correspond with the size of this page. If the dimensions of the paper output still deviate slightly from the measurements indicated here, use the measurements indicated here.

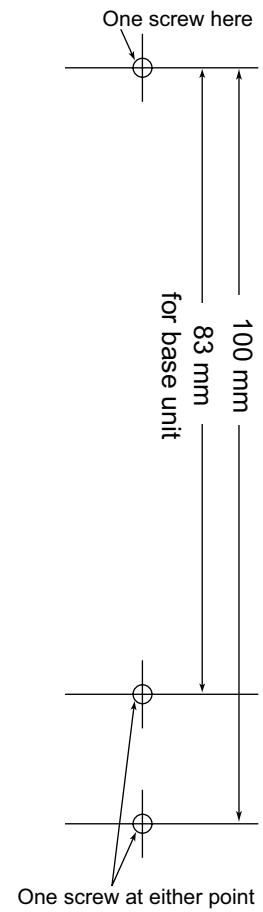

## Notes

---



## **Panasonic System Networks Co., Ltd.**

1-62, 4-chome, Minoshima, Hakata-ku, Fukuoka 812-8531, Japan

**<http://panasonic.net/pcc/support/sipphone>**

### **Copyright:**

This material is copyrighted by Panasonic System Networks Co., Ltd., and may be reproduced for internal use only. All other reproduction, in whole or in part, is prohibited without the written consent of Panasonic System Networks Co., Ltd.

© Panasonic System Networks Co., Ltd. 2011

**PNQX3563TA** DD0811MK6033