

A68(W) Quick Start Guide

Version 1.0

2016-03-21

Content

1. Installation and access.....	3
1.1 Connection.....	3
1.2 Stand bracket installation instruction.....	3
1.3 Wiring instruction.....	6
2. Configuring phone.....	7
2.1 Configuring via keypad.....	7
2.2 Configuring via Webpage.....	8
2.2.1 Login to web.....	8
2.2.2 Network Configuration.....	8
2.2.3 Account Configuration.....	10
2.3 Wi-Fi(only for A68W).....	13
2.3.1 Configure the wifi on the phone.....	13
2.3.2 Configure the wifi on the WEB.....	13

1. Installation and access

1.1 Connection

Set up A68 as below:

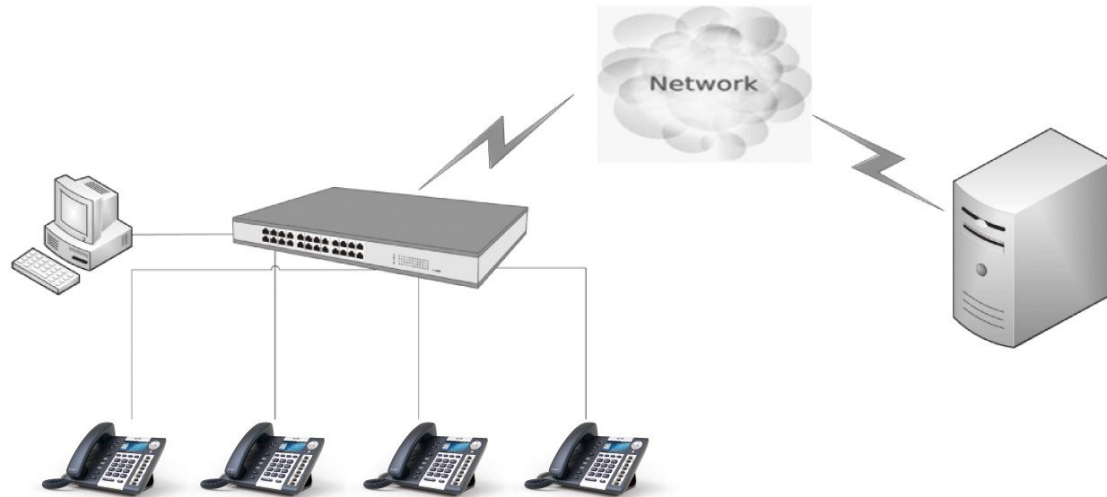

1.2 Stand bracket installation instruction

A. Put the bottom side of the IP phone upside and press one-side joints of stand bracket into the slot, please refer the picture as below:

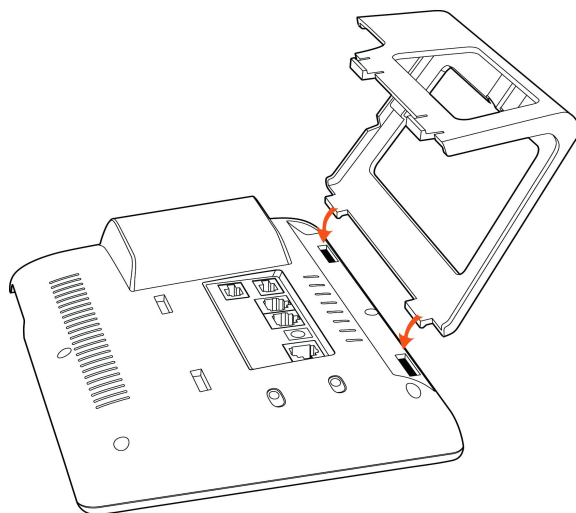

B. Press the other side joints into the slot according to the direction of the arrow:

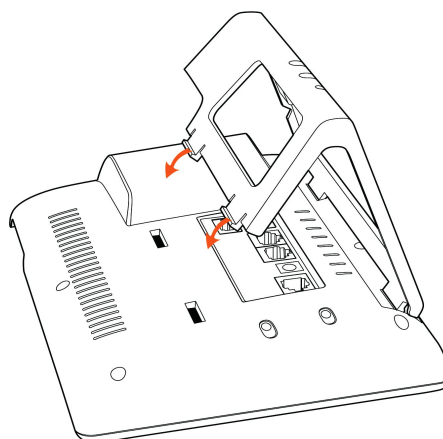

C. It is the right picture after fixing the stand bracket below:

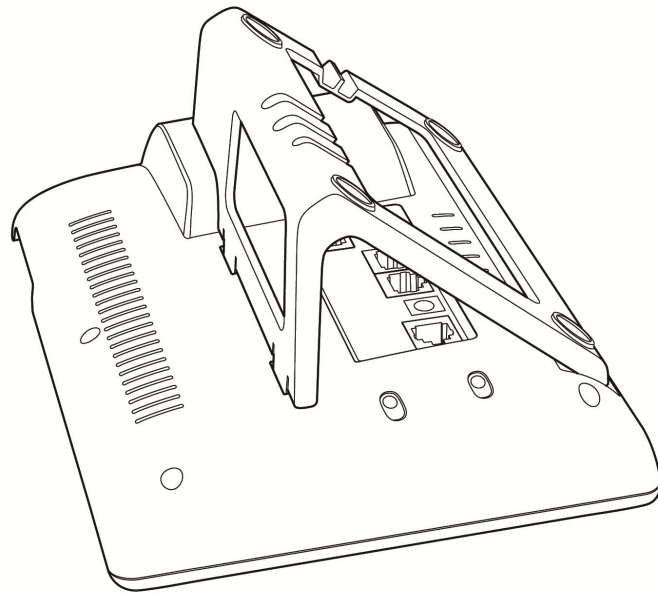

D. Disassemble the stand bracket:

Push the spring joint of stand and pull the stand according to the direction of the arrow. When the joints are pulled out of the slot, you can take off the stand bracket.

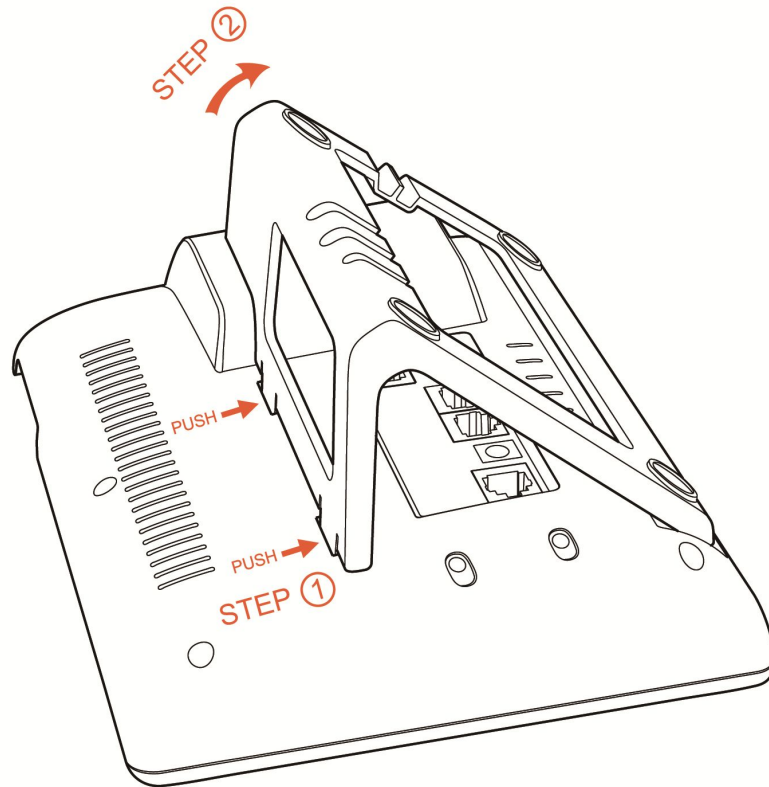

1.3 Wiring instruction

After stand bracket fixed, please plug in all wires or cables as below:

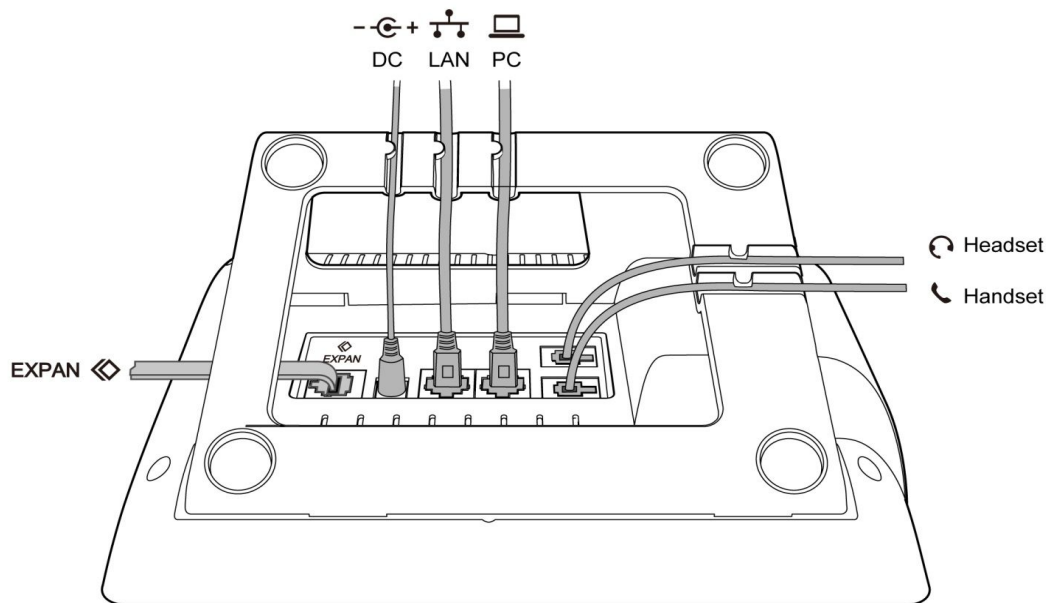

2. Configuring phone



A68(W)



A68(W) with RET

2.1 Configuring via keypad

Language Setting: The default language of the phone is English, it supports Chinese, Russian, Arabic, German, French, Portuguese, Turkish, Spanish, Hebrew, Hungarian, Italian.

Press **Menu- Setting- Basic Setting- Language** to edit the language list, choose the one you'd like to set on the phone.

Note: The available language maybe different, it depends on the language packs currently loaded to the IP phone.

Network Setting:

Press **Menu- Setting- Basic Setting-** input default password `admin`- **Network- LAN Prot/ PC Port/ VLAN/Web server** to enter the internet related configuration page.

Or review its current IP address by pressing  key when it is powered on and connected to the network.

Account Setting:

Press Menu- Setting- Basic Setting- input default password `admin`- Account- Enter to configure the account setting. You can refer to the bellow `Configuring via Web page` for the parameter details.

2.2 Configuring via Webpage

2.2.1 Login to web

Connect the PC and telephone in one network, input the IP address of telephone at a browser and press "Enter", you will be required to input the username and password to access the web page. The username/password as below:

Username	Password	Description
admin	admin	For Administrators
user	user	For General Users

2.2.2 Network Configuration

There are 3 options for network access.

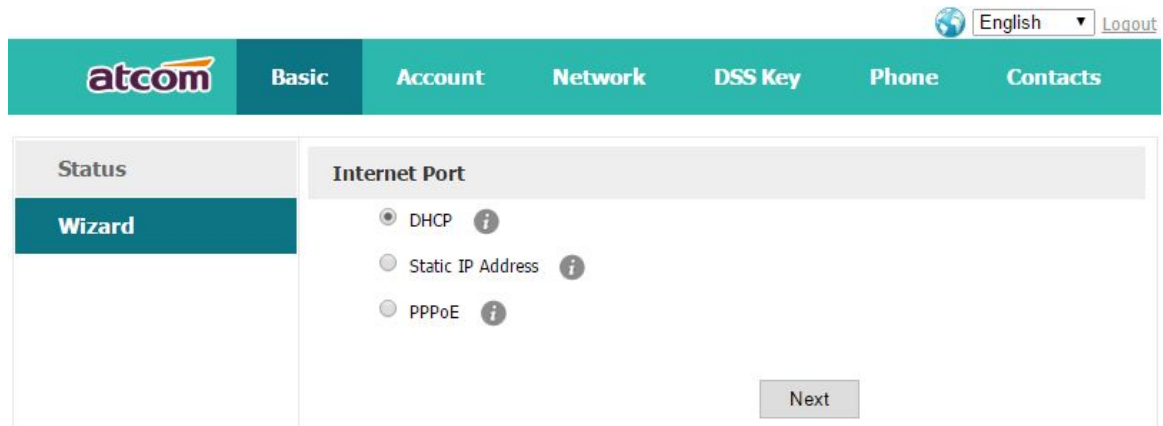

The screenshot shows the atcom web interface. At the top right, there is a language dropdown set to 'English' and a 'Logout' link. Below this is a teal navigation bar with the atcom logo and menu items: Basic, Account, Network, DSS Key, Phone, and Contacts. The main content area is divided into two columns. The left column has a 'Status' section with 'Wizard' selected. The right column is titled 'Internet Port' and contains three radio button options: 'DHCP' (which is selected), 'Static IP Address', and 'PPPoE'. Each option has an information icon (i) to its right. A 'Next' button is located at the bottom right of the 'Internet Port' section.

1.If chosen DHCP, the telephone will be assigned a IP address automatically, click the button "**Next**" to enter the web page of "**Account Configuration**".

2. If chosen Static IP, user should input the IP address manually for the telephone, click the button "**Next**" to enter the web page of "Static IP Address".

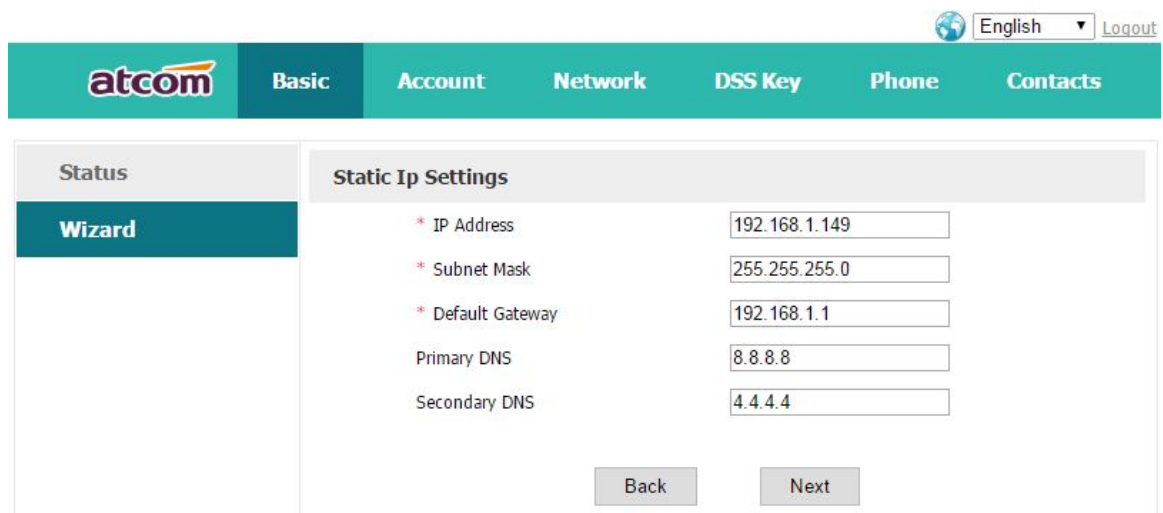

The screenshot shows the atcom web interface. At the top right, there is a language dropdown set to 'English' and a 'Logout' link. Below this is a teal navigation bar with the atcom logo and menu items: Basic, Account, Network, DSS Key, Phone, and Contacts. The main content area is divided into two columns. The left column has a 'Status' section with 'Wizard' selected. The right column is titled 'Static Ip Settings' and contains five input fields: '* IP Address' (192.168.1.149), '* Subnet Mask' (255.255.255.0), '* Default Gateway' (192.168.1.1), 'Primary DNS' (8.8.8.8), and 'Secondary DNS' (4.4.4.4). At the bottom of the 'Static Ip Settings' section, there are 'Back' and 'Next' buttons.

After IP address filled manually, click the button "**Next**" to enter the web page of "**Account Configuration**", or click the button "**Back**" to back to web page of "**Network Configuration**".

3.If chosen PPPOE, user should input the username/password (provide by ISP) of PPPOE manually and then click the button "**Next**" to enter the web page of "**PPPOE**",

English ▼ [Logout](#)

atcom
Basic
Account
Network
DSS Key
Phone
Contacts

Status	PPPoE Settings
Wizard	<p>* User <input style="width: 150px;" type="text" value="pppoe"/></p> <p>* Password <input style="width: 150px;" type="password" value="....."/></p> <p style="text-align: center;"> <input type="button" value="Back"/> <input style="margin-left: 50px;" type="button" value="Next"/> </p>

After the username/password of PPPoE filled manually, click the button **"Next"** to enter the web page of **"Account Configuration"**, or click the button **"Back"** to back to web page of **"Network Configuration"**.

Network Configuration can be completed in below webpage,

English ▼ [Logout](#)

atcom
Basic
Account
Network
DSS Keys
Phone
Contacts

Basic	Internet Port
Wi-Fi	<p><input checked="" type="radio"/> DHCP i</p> <p><input type="radio"/> Static IP Address i</p> <p style="margin-left: 20px;">* IP Address <input style="width: 100px;" type="text"/></p> <p style="margin-left: 20px;">* Subnet Mask <input style="width: 100px;" type="text"/></p> <p style="margin-left: 20px;">* Default Gateway <input style="width: 100px;" type="text"/></p> <p style="margin-left: 20px;">Primary DNS <input style="width: 100px;" type="text"/></p> <p style="margin-left: 20px;">Secondary DNS <input style="width: 100px;" type="text"/></p> <p><input type="radio"/> PPPoE i</p> <p style="margin-left: 20px;">* User <input style="width: 100px;" type="text"/></p> <p style="margin-left: 20px;">* Password <input style="width: 100px;" type="password"/></p> <p style="text-align: center;"> <input type="button" value="Confirm"/> <input style="margin-left: 50px;" type="button" value="Cancel"/> </p>
Advanced	

2.2.3 Account Configuration

The account configuration info will be saved to Line 1.

atcom		Basic	Account	Network	DSS Key	Phone	Contacts	
Status	SIP Settings							
Wizard	Account Active	Enable ▼						
	Label	<input type="text"/>					i	
	Display Name	<input type="text"/>					i	
	Register Name	<input type="text"/>					i	
	* User Name	<input type="text" value="6030"/>					i	
	Password	<input type="password" value="****"/>					i	
	* SIP Server	<input type="text" value="192.168.1.123"/>	Port	<input type="text" value="5060"/>			i	
		<input type="button" value="Back"/>		<input type="button" value="Finish"/>				

Click the button "**Finish**" to save network configuration and account configuration, and click "**Back**" back to the previous web page.





















Account Configuration can be completed in below webpage,

 English Logout

Basic
Account
Network
DSS Keys
Phone
Contacts

Basic
Codecs
Advanced

Account
Account 1 

Register Status	Registered	
Account Active	Enable 	
Label	<input type="text"/>	
Display Name	<input type="text"/>	
Register Name	<input type="text"/>	
* User Name	<input type="text" value="6030"/>	
Password	<input type="password" value="••••"/>	
* SIP Server	<input type="text" value="192.168.1.123"/>	Port <input type="text" value="5060"/> 
Enable Outbound Proxy Server	Disable 	
Outbound Proxy Server	<input type="text"/>	Port <input type="text" value="5060"/> 
Enable Peer-to-Peer	Disable 	
Transport Type	UDP 	
NAT Traversal	STUN 	
STUN Server	<input type="text"/>	Port <input type="text" value="3478"/> 
Voice Mail	<input type="text"/>	
Anonymous Call	Off 	
On Code	<input type="text"/>	
Off Code	<input type="text"/>	
Anonymous Call Rejection	Off 	
On Code	<input type="text"/>	
Off Code	<input type="text"/>	
Ring Tones	Common 	

Confirm
Cancel

- ✓ Enable: whether enable this SIP register.
- ✓ Label: The name of the displayed on the phone LCD.
- ✓ Display Name: This name will display on the screen of A68. It will display the name configured for the SIP account by the SIP server preferentially. It can also be kept blank.
- ✓ Register ID: normally is the same as User ID, can also be kept blank if there is no special requirement from the SIP server.
- ✓ User ID: Username of SIP account.
- ✓ Password: Password of SIP account.
- ✓ Sip Server: SIP server address, support both IP address and domain name.
- ✓ Sip Port: SIP server port, default is 5060.

2.3 Wi-Fi (only for A68W)

2.3.1 Configure the wifi on the phone

1、 Press **"Menu"**-**"Network"**-**"Connect Mode"**,change for the wifi connection mode,press **"OK"**.

2、 Press **"Menu"**-**"Network"**-**"WIFI setting"**-**"WLAN"**,choose the wifi you want to connect,Press **"Connect"**,then input the correct wifi password.

3、 Return to the standby interface,and phone successful connected to the wifi.

2.3.2 Configure the wifi on the WEB

A68 connect to network via Wi-Fi acquiescently, click **"Search Wi-Fi"** button to search the available Wi-Fi.

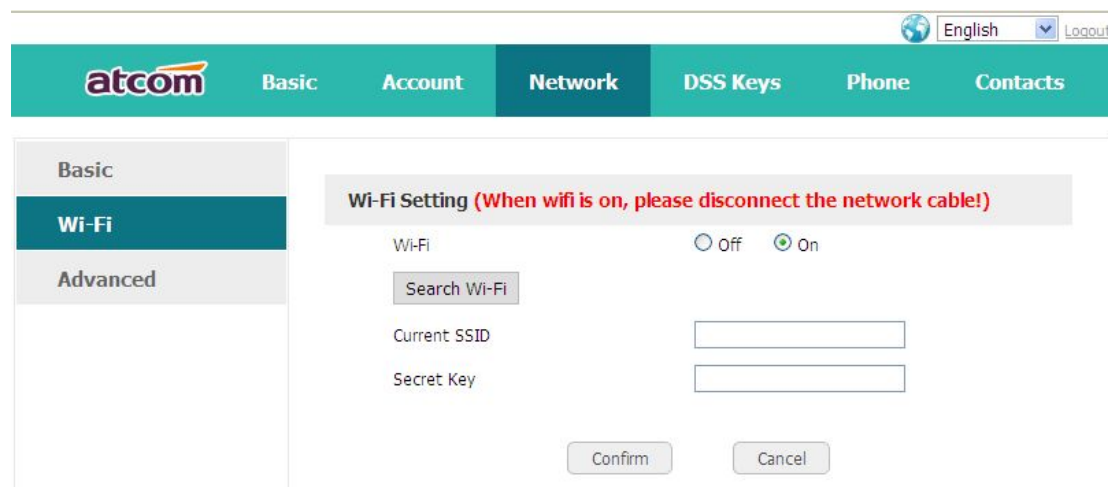

The screenshot shows the web interface for configuring Wi-Fi. At the top, there is a navigation bar with the 'atcom' logo and tabs for 'Basic', 'Account', 'Network', 'DSS Keys', 'Phone', and 'Contacts'. The 'Network' tab is selected. Below the navigation bar, there is a sidebar with 'Basic', 'Wi-Fi', and 'Advanced' options. The 'Wi-Fi' option is selected. The main content area is titled 'Wi-Fi Setting (When wifi is on, please disconnect the network cable!)'. It contains a 'Wi-Fi' toggle switch set to 'On', a 'Search Wi-Fi' button, and two input fields for 'Current SSID' and 'Secret Key'. At the bottom, there are 'Confirm' and 'Cancel' buttons. In the top right corner, there is a language dropdown set to 'English' and a 'Logout' link.

After all available Wi-Fi hotspots are list out, click the round behind the available Wi-Fi which you want to connect.

Index	SSID	Signal	Select
1	cisco	211	<input type="radio"/>
2	360	207	<input type="radio"/>
3	re	207	<input type="radio"/>
4	amoji	205	<input type="radio"/>
5	CHINA TELECOM	205	<input type="radio"/>
6	360_____WIFI-C9	197	<input type="radio"/>
7	_____	197	<input type="radio"/>
8	_____	190	<input type="radio"/>
9	inWatch3	189	<input type="radio"/>
10	ChinaNet-7A6t	188	<input type="radio"/>
11	360_____WIFI-9F	185	<input type="radio"/>
12	iTV-7A6t	185	<input type="radio"/>
13	inWatch2	185	<input type="radio"/>
14	Royale International China	184	<input type="radio"/>

Input the right “**Secret Key**” and then click the “**Confirm**” button, the phone will reboot, and you should disconnect the wire that connect to A68 during rebooting, or the phone will connect to network via wire preferentially. The Wi-Fi icon will display on the home screen, it means connect failed when the icon come with , you should to check the configuration.