

# Savi® W740-M

Multi Device Wireless Headset System

User Guide



# Contents

Welcome	4
System Requirements	4
DECT Enhanced Security	4
DECT Information	4
What's in the Box	6
Base and Headset Basics	7
Accessories	8
Customize Your Headset	9
Install the Headset Battery	9
Use the Fit Kit to Assemble Your Headset	9
Right Over-the-Ear Assembly	9
Left Over-the-Ear Assembly	9
Position Your Headset	10
Over-the-Head Assembly	11
Behind-the-Head Assembly	11
Charge Your Headset	13
Desk Phone: Connect and Call	14
Choose Desk Phone Setup	14
Make a Desk Phone Call	15
Mobile: Connect and Call	16
Computer: Connect and Call	17
Connect Your Computer	17
Place a Softphone Call	17
Position Your Base	17
Audio streaming	17
Headset Features	19
Headset Controls	19
Headset Power	19
Headset Battery Level	20
Mute your Headset During a Call	20
Adjust Your Headset Volume	21
Turn On/Off Headset LED	21
Out of Range Warning Tones	21
Base Features	23
Base Buttons	23
Base Subscription Button	23
Bluetooth Pairing Button	25
Daily Use	26
Incoming Calls	26
Outgoing Calls	26
Multi-Phone Status	28
Mobile Phone and Headset Audio	28
Listening to Other PC Audio	28
Combine Audio From Any Two Lines or Channels	28
Conference Up to Three Additional Headsets	28
Conferencing Additional Headsets and Security Levels	29

Advanced Use	<b>30</b>
Install Plantronics Hub	<b>30</b>
Start Hub	<b>30</b>
Hub Tabs	<b>30</b>
Hub Settings Options	<b>31</b>
Ring Tones and Volumes	<b>33</b>
Softphones and Media Players	<b>33</b>
Presence	<b>34</b>
Wireless	<b>34</b>
Advanced	<b>35</b>
Additional Device Management Tools	<b>36</b>

# Welcome

Congratulations on purchasing your new Plantronics product. This guide contains instructions for setting up and using your Savi W740 Wireless Headset System which has a WO2 base and a WH500 headset.

Please refer to the separate safety instructions for important product safety information prior to installation or use of the product.

## System Requirements

### Computer

- Supported Operating Systems: Windows Vista® Windows® 7, Windows® 8, 8.1
- Processor: 400 MHz Pentium® processor or equivalent (Minimum); 1 GHz Pentium processor or equivalent (Recommended)
- RAM: 96 MB (Minimum); 256 MB (Recommended)
- Hard Disk: 280 MB (Minimum); 500 MB or more (Recommended)
- Microsoft® Windows XP® Service Pack 3 (SP3) or later (Recommended) Microsoft Windows Vista Service Pack 1 (SP1) or later (Recommended)

### Display

- At least 800 x 600, 256 colors
- 1024 x 768 high color, 32-bit (Recommended)

### Browser

- Internet Explorer® V10 or better must be on the user's system (Required)

## DECT Enhanced Security

Plantronics is a member of the DECT Forum has fully adopted their recommendations for enhancements to security within all DECT products.

Plantronics DECT-based products now fully incorporate the latest recommendations on Enhanced Security from the DECT Forum and ETSI. These improvements cover registration, authentication, authorization and encryption procedures. Plantronics DECT products are now secure against all the known vulnerabilities that were highlighted by the public announcements of the Chaos Council in 2009.

Plantronics Savi 700 Series DECT products have been tested against and passed the DECT Forum security certification requirements and consequently have been granted 'DECT Forum security' logo certification.

Plantronics products using the new enhanced version of DECT that includes these security improvements are marked on the base with the DECT Forum security logo.



## DECT Information

The enclosed DECT 6.0 wireless product uses restricted wireless radio frequencies which vary by country. DECT 6.0 devices are generally authorized for use in The Americas. Use of this DECT 6.0 product in unauthorized countries is a violation of law, may disrupt telecommunications networks and devices, and can subject you to fines and penalties by regulatory agencies. For specific countries in which DECT 6.0 devices may be lawfully used, please consult the following: <http://www.dect.org/content.aspx?id=28>



# What's in the Box

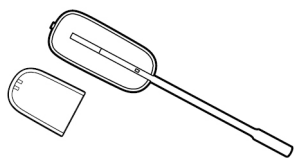

Headset and battery

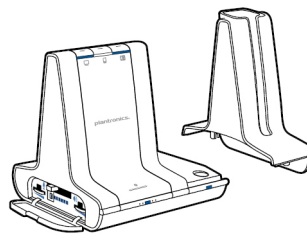

Base and charging cradle



Over-the-head headband

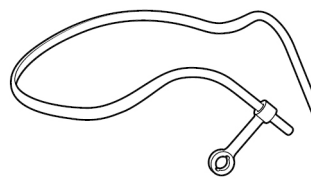

Behind-the-head headband

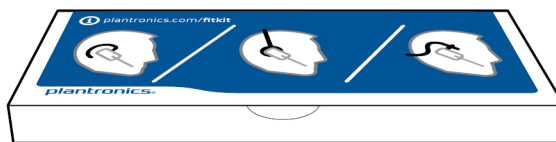

Headset fit kit with earloops, eartips and foam sleeve



USB cable

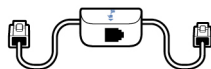

Telephone interface cable

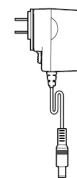

Power supply

# Base and Headset Basics

## Base

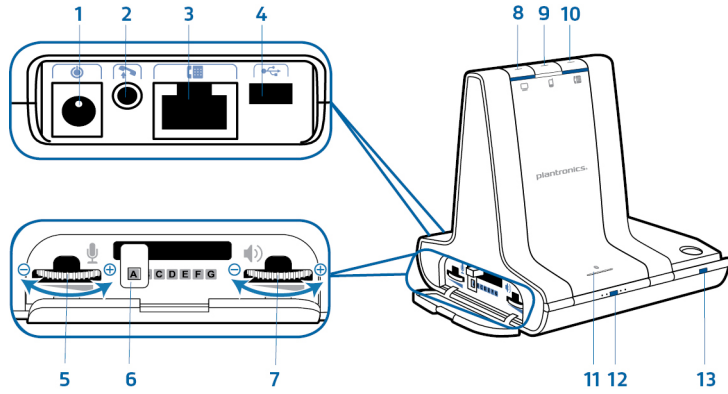

- 1 Power jack
- 2 Handset lifter jack
- 3 Telephone interface cable jack
- 4 USB port
- 5 Desk phone speaking volume
- 6 Desk phone configuration switch
- 7 Desk phone listening volume

- 8 Computer button
- 9 Mobile phone button
- 10 Desk phone button
- 11 Bluetooth pairing button/LED
- 12 Subscription button/LED
- 13 Charging LED

## Headset

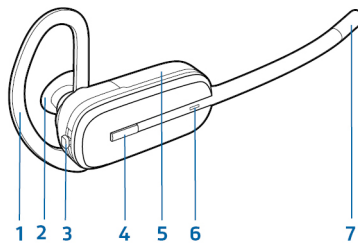

- 1 Earloop
- 2 Eartip
- 3 Volume/Mute button
- 4 Call control button

- 5 Battery
- 6 Headset LED
- 7 Microphone

# Accessories

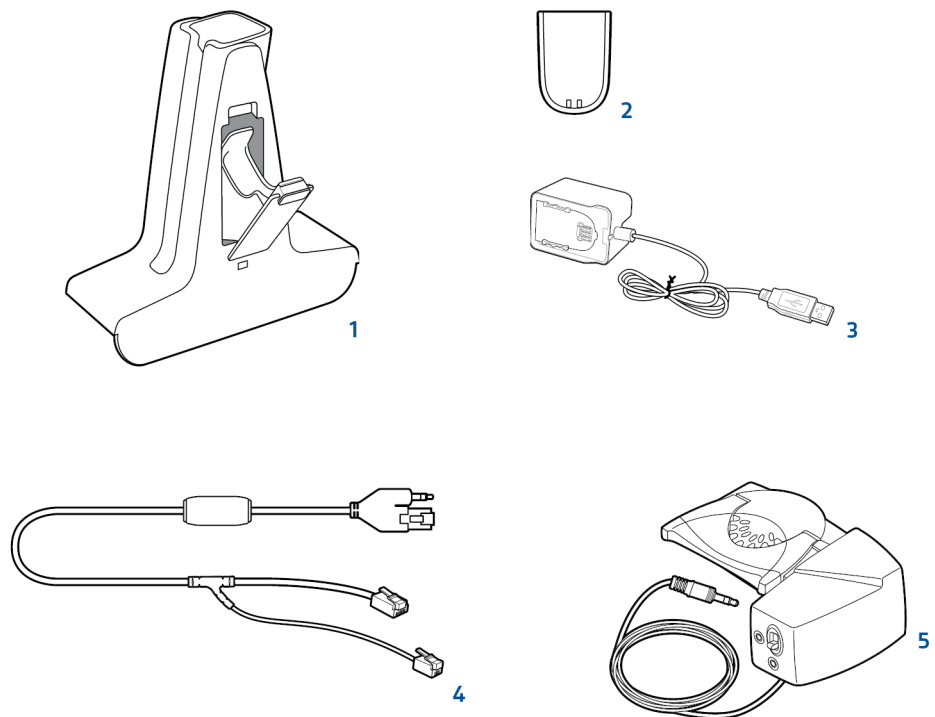

- 1 Deluxe charging cradle** Charges an extra battery while charging your headset
- 2 Spare battery**
- 3 Deluxe USB charging cable** Charges an extra battery while charging your headset via a USB port
- 4 Electronic hookswitch cable (EHS cable)** Electronically and automatically takes your desk phone handset off hook. Enables remote call control with your headset.
- 5 HL10 lifter** Automatically lifts handset and returns it to the cradle. Enables remote call control with your headset.



# Customize Your Headset

After you install the headset battery, choose one of the three headset wearing styles, over-the-ear, over-the-head or behind-the-head. Use the fit kit to assemble it and optimize the position of the microphone.

## Install the Headset Battery

Position the battery as shown on the headset and slide into position until the battery snaps into place.

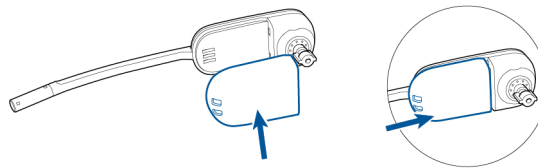

**NOTE** This product has a replaceable battery. Use only the battery type supplied by Plantronics.

## Use the Fit Kit to Assemble Your Headset

Choose a headset wearing style and use the fit kit to assemble it over-the-ear, over-the-head or behind-the-head.



## Right Over-the-Ear Assembly

- 1 Choose the size of earloop that fits most comfortably. Align the earloop as shown and insert it onto the headset. Rotate the earloop up 90°.

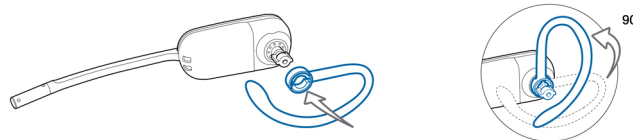

**NOTE** Ensure the earloop is flat against the headset before rotating.

- 2 Choose the size and style of eartip that fits most comfortably. Align the eartip with the notch facing the microphone as shown. Press on to attach.

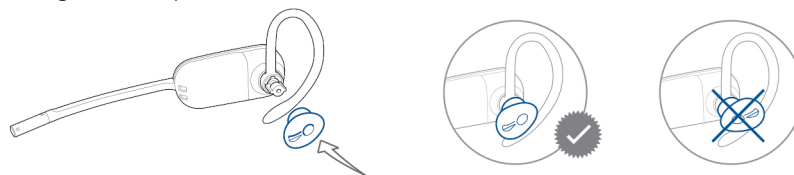

**NOTE** Ensure the large end of the eartip points to the microphone.

- 3 To correctly position your headset, see Position Your Headset.

## Left Over-the-Ear Assembly

- 1 Choose the size of earloop that fits most comfortably. Align the earloop as shown and insert it onto the headset. Rotate the earloop up 90°.

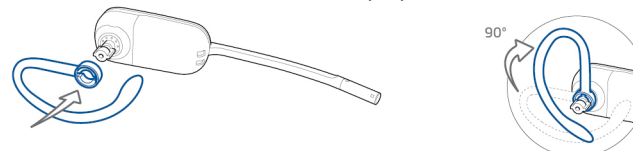

**NOTE** Ensure the earloop is flat against the headset before rotating.

- 2 Choose the size and style of eartip that fits most comfortably. Align the eartip with the notch facing the microphone as shown. Press on to attach.

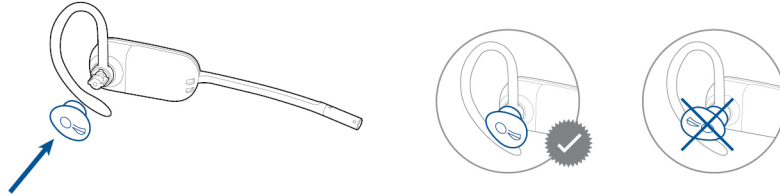

**NOTE** Ensure the large end of the eartip points to the microphone.

- 3 To correctly position your headset, see Position Your Headset.

### Position Your Headset

When you wear the headset, the microphone should rest as close to your cheek as possible without touching. The microphone can be adjusted inward by the pivoting eartipiece to optimize the position of the headset.

- 1 Slide the headset over and behind your ear and fit the eartip into your ear.

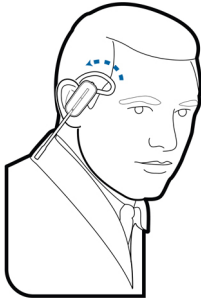

- 2 Holding the base of the headset, push it in and back towards your ear to allow the pivoting eartipiece to bring the microphone close to your mouth. As the base of the headset moves backwards, you will feel soft clicks until the microphone rests close to your cheek.

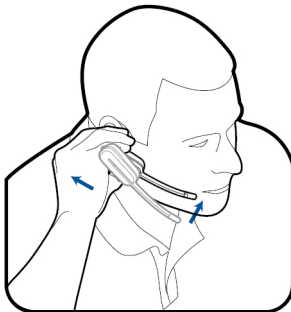

Over-the-Head Assembly

- 1 Hold the headband so it is aligned to receive the headset as shown and insert the headset into the headband.

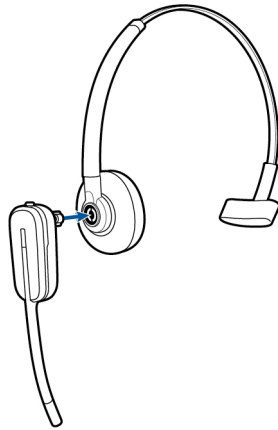

- 2 Rotate the headset up. The headband can be worn on the right or left side.

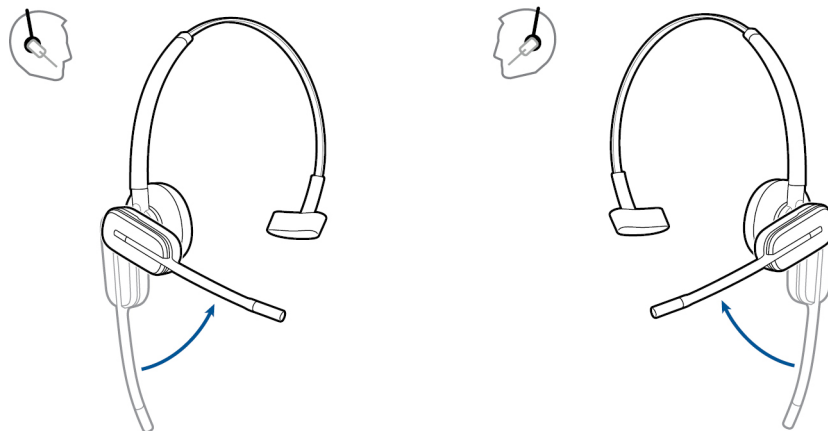

- 3 To optimize the position of the headset, push the headset in so the microphone is close to your mouth.

Behind-the-Head Assembly

- 1 Align the headband as shown. Ensure the headband sits flat against the headset, then rotate it up 90°. If you want to wear it on the left, switch the stem to the left side of the headset.

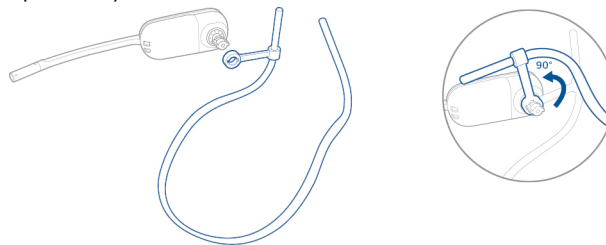

- 2 Choose the size and style of the eartip that fits most comfortably. Align the eartip with the notch facing the microphone as shown. Press on to attach.

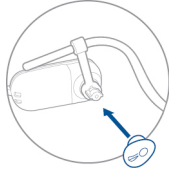

**NOTE** *Ensure the large end of the eartip points to the microphone.*

- 3 To position your headset correctly, first slide the stem of the headband so the headset fits comfortably.

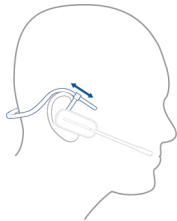

- 4 With a finger on the headset indicator light, push in until the microphone rests as close to your cheek as possible without touching.

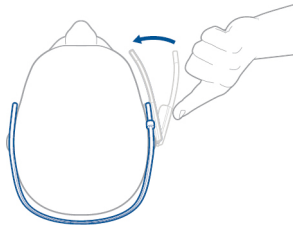

# Charge Your Headset

- 1 Align the charging cradle pins with the base and press firmly until the cradle rests evenly on the base.

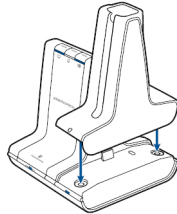

- 2 Plug one end of power supply into power jack on back of the base and other end into working power outlet.

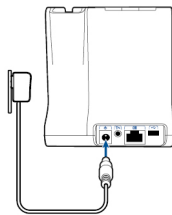

- 3 Place the headset in the charge cradle. The charging LED will flash green when charging the headset and turn solid green when the headset is fully charged. Charge for at least 20 minutes prior to the first use. A full charge takes 3 hours.

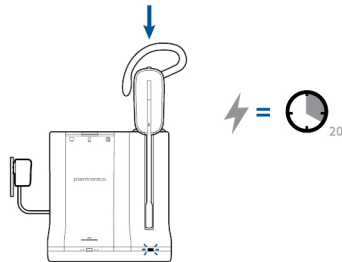

**NOTE** This product has a replaceable battery. Use only the battery type supplied by Plantronics.

# Desk Phone: Connect and Call

Choose Desk Phone Setup

Choose a desk phone setup **A**, **B** or **C** and connect cables.

## A Desk phone (standard)

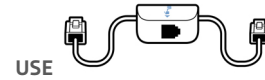
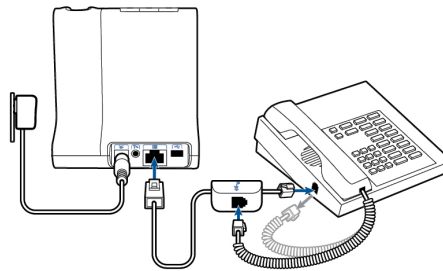

- Connect one end of the telephone interface cable to the back of the base
- Disconnect the handset coil cord from the base of the desk phone and re-connect it to the telephone interface cable junction box.
- Finally connect the remaining end of the telephone interface cable into the open handset port on the desk phone.

**NOTE** If your phone has a built-in headset port, you should only use the headset port if you will not be using the HL10 lifter. In this configuration, you must press both the headset button on your phone and the call control button on the headset to answer or end calls.

## B Desk phone + HL10 lifter (sold separately)

See the user guide at [plantronics.com/accessories](http://plantronics.com/accessories) for details.

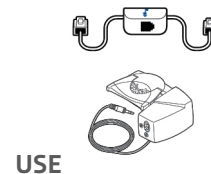
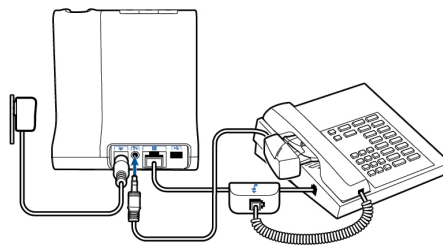

## C Desk phone + EHS cable (sold separately)

See the user guide at [plantronics.com/accessories](http://plantronics.com/accessories) for details.

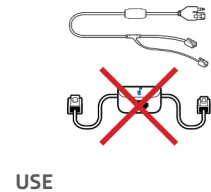
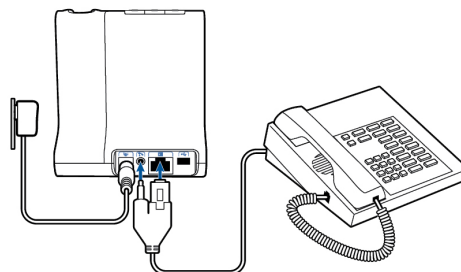

Make a Desk Phone Call 1 While wearing headset, short press base desk phone button.

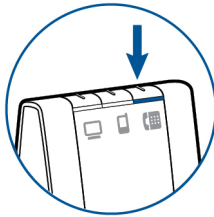

**NOTE** If you don't have remote call control through a lifter (HL10) or cable (EHS), manually remove desk phone handset before each call.

2 If you do not hear a dial tone, open side panel and adjust middle configuration switch A-G until you do. Default setting A works for majority of desk phones.

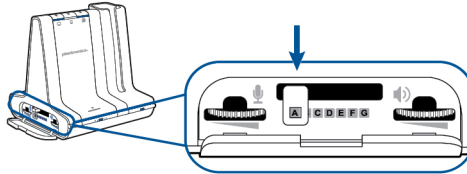

3 Dial test call from desk phone.

4 End call by pressing headset call control button.

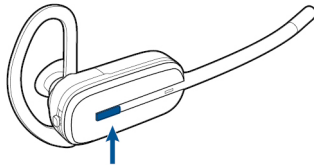

# Mobile: Connect and Call

Your mobile phone can be paired to multiple headsets and hands-free devices, but it can only be connected to one device at a time. Following are instructions for pairing your mobile phone to the base.

- 1 Press down and hold Bluetooth pairing button (4 seconds) on Savi base until indicator LED flashes red and blue. The base will remain in this mode for 10 minutes. If it goes off, you will need to press it again.

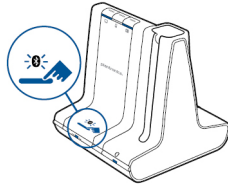

- 2 Place Bluetooth mobile phone into search mode. Select **SAVI 7xx** from the list of found devices.

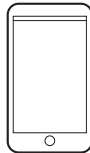

- 3 If prompted by mobile phone, type **0000** as passcode. Bluetooth indicator LED on base will turn solid blue when base has an active connection with mobile phone.

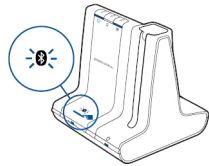

- 4 While wearing headset, short press base mobile button.

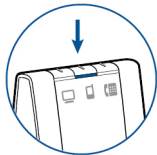

- 5 Dial test call from mobile phone.
- 6 End call by pressing headset call control button.

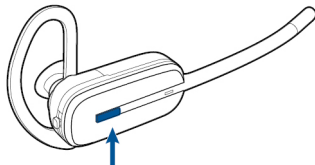



# Computer: Connect and Call

## Connect Your Computer

Connect the USB cable.

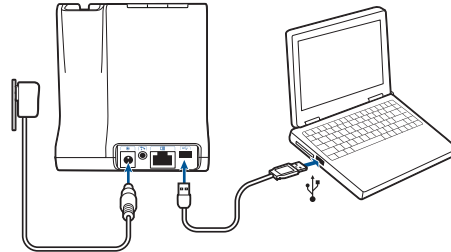

Place a Softphone Call 1 While wearing your headset, short press the base computer button.

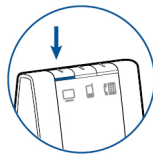

- 2 Dial a call from your computer softphone.
- 3 End the call by pressing the headset call control button.

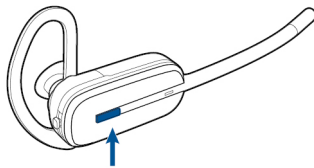

## Position Your Base

The minimum recommended separation between your desk phone and the base is 6 inches.

The minimum recommended separation between the base and computer is 12 inches. Incorrect position can cause noise and interference problems.

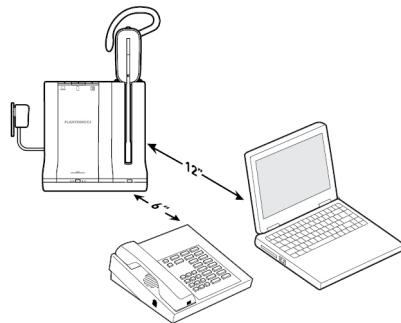

## Audio streaming

Savi 700 series supports Bluetooth A2DP audio streaming and playback of media-based content for listening on all Savi 700 series headsets. To listen to steaming media, follow these steps:

- 1 Assure your A2DP compatible mobile phone is paired to the Savi base per instructions above.
- 2 Begin playing media from desired application on your mobile phone.
- 3 While wearing the headset, press base mobile button to play audio on headset.
- 4 If media does not begin playing, assure "Savi 7xx" is selected from your list of connected Bluetooth devices.

- 5 To stop media playing, press the base mobile button again.

# Headset Features

## Headset Controls

Now that you've assembled your headset, installed the software and connected your phones, read this section to learn about the headset features, how to use the controls and more.

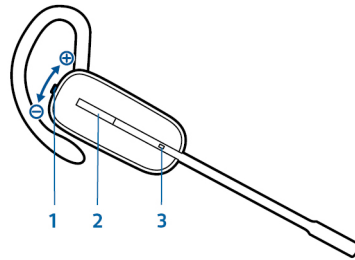

---

### 1 Volume/Mute button

Decrease the volume	Press the volume button down
Increase the volume	Press the volume button up
Mute/unmute a call	To mute/unmute the headset, press the volume/mute button in
Flash between calls	During a call, long press the volume button up or down for 1.5 seconds

---

### 2 Call button

Place, answer, end a call    Short press the call control button

### 3 Headset LED    Flashes white when in use

---

**CAUTION** For your safety, do not use headset at high volumes for extended periods of time. Doing so can cause hearing loss. Always listen at moderate levels. For more information on headsets and hearing visit [plantronics.com/healthandsafety](http://plantronics.com/healthandsafety).

### Change Volume Orientation

Savi 740/745 headsets ship by default in the right ear wearing configuration. If worn on the left ear, volume controls will be reversed. To orient the volume controls for the left ear configuration, follow these steps:

- 1 With the headset docked in the base, push the volume button in the direction you wish to be Volume Up.
- 2 Hold for 3 seconds until the headset LED triple blinks indicating volume orientation has been changed successfully.

## Headset Power

If the headset battery is installed and charged, the headset is automatically on. The headset does not have an on/off button. If you won't be using the headset for a long period of time and the headset will not be in the charging cradle, place the headset in sleep mode or remove the battery.

### Place the Headset in Sleep Mode

Placing the headset in sleep mode with a fully charged battery will provide up to 50 hours of standby time.

- 1 While the headset is idle, press the call button for three seconds until you see the headset flash white twice. .
- 2 To wake the headset, press the call button again until you see two white flashes or hear three high tones.

### Battery Storage Time

If you remove a fully charged battery from the headset, it will provide up to 75 days of battery storage time, stored under normal conditions.

### Talk Time

With a single full charge, the headset will provide up to 7 hours of continual talk time. Talk time will be reduced when operating in wideband mode and/or if the headset is used consistently at a long distance from the base. You can replace the battery mid-call, without losing the call, as long as a charged battery is reattached within 5 minutes. This allows for unlimited talk time.

### Power consumption

Once the headset battery is fully charged the product enters a networked standby mode. The period of time taken to enter this mode depends on how long the battery takes to fully charge. In a networked standby mode the product consumes 1.9 Watts.

The wireless network port(s) of this product are designed to be always active.

## Headset Battery Level

### Low Battery Warning

If you are on a call and the headset battery is critically low, you will hear a repeated single low tone every 15 seconds indicating that the battery is low. You should recharge the headset immediately or swap out the low battery with a fully-charged battery.

If you are not on a call and press the call button, you will hear three low tones if the battery is critically low. You should recharge the headset immediately or swap out the low battery with a fully-charged battery.

### Headset Battery Status

There are two ways to determine your headset battery status.

#### View System Tray Icon

With Plantronics software installed, a headset icon will appear in your system tray, displaying battery status. A warning will be issued if your headset's battery is critically low.



#### Use the Base

When the system is idle, short press the base subscription button once to get feedback on the headset battery level. The computer, mobile and desk phone button LEDs will light up, indicating your headset battery level.

Headset Battery Level	Computer Button LED on base	Mobile Button LED on base	Desk Phone Button LED on base
75–100%			
50–75%			
25–50%			
0–25%			

To mute/unmute a call, press the volume/mute button in.

Mute your Headset  
During a Call

When mute is activated, the base button will be solid red and you will hear three high tones (you will still be able to hear the caller). These tones will repeat every 60 seconds while mute is active. When unmuted, you will hear three low tones.

Adjust Your Headset  
Volume

Fine-tune your headset volume by pressing the volume/mute button up (increase) or down (decrease) if you wear your headset on the right. If you wear it on the left, it's opposite: press down to increase the volume and up to decrease the volume.

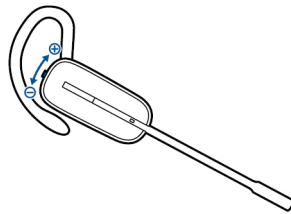

Make general volume adjustments for the desk phone with the base volume dials.

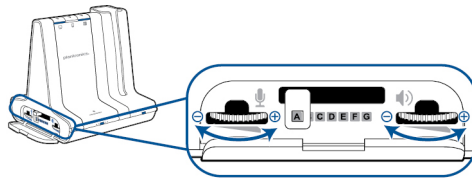

For computer volume adjustments, use your softphone application controls or your computer's audio control panel (see below). Mobile phone volume can be adjusted on the mobile phone.

**NOTE** You can quickly access your system's control panel by using the link in the Plantronics Control Panel on the Preferences Tab.

**For Windows Vista and Windows 7 systems**

Adjust your overall volume by going to: Start Menu > Settings > Control Panel > Sound > Playback. Click "OK" to confirm your change.

**For Windows XP systems**

Adjust your overall volume by going to: Start Menu > Settings > Control Panel > Sounds and Audio Devices > Audio tab > Sound Playback. Click OK to confirm changes.

Turn On/Off Headset LED

The headset LED will flash when you are on a call or the headset is in use. The LED can be turned off.

When you are not on a call, press the headset volume down button for three seconds until the headset flashes white twice to toggle the LED on or off.

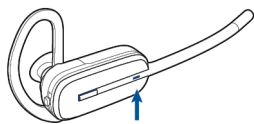

Out of Range Warning  
Tones

If you are on a call and go out of the operating range, you will hear three low tones. You will hear a single mid tone when you are back in range.

If you stay out of range, active calls will be suspended. Calls will be re-established when you walk back into range. If you remain out of range for more than 5 minutes, the system will drop the call.

If you are not on a call and go out of the operating range and press the call button, you will hear a single tone for the button press and three low tones for the failure to make a link.

# Base Features

This section describes the base, its buttons and their functions.

## Base Buttons

### Basics

When you press on a base button, you are opening a phone line/audio channel. Depending on the circumstances, you won't necessarily hear a dial tone until you've dialed from your phone. The base buttons allow you to switch to a different phone line/audio channel.

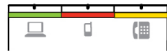

### Change your default outbound line

This feature sets the preferred outbound line when the headset call control button is pushed while all lines are idle.

With the system idle, you can change your default outbound line by pressing the desired outbound base button until it flashes green four times.

You can also change the default outbound line using the Plantronics Hub by going to Start > Programs > Plantronics > Plantronics Hub > Settings > General > Default Phone Line.

## Base Subscription Button

The headset and base that came in the box are subscribed (connected) to each other. However, if you wish to use a new headset or need to restore subscription to your current headset (base subscription button is red), the units can be subscribed to each other by the following methods.

The subscription button is the silver trim with four dots on the front of the base.

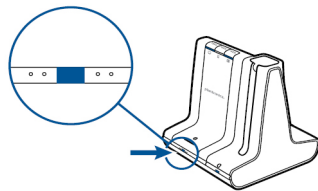

### Automatic secure subscription

With your system idle, docking a new headset will automatically subscribe it to the base, making it the primary headset. The base subscription LED will blink green/red during subscription mode and remain green when the new subscription is established.

### Manual secure subscription

With your system idle and your headset docked, double press the subscription button on the base. The subscription light will flash red and green. When the subscription light on the base becomes solid green, the headset and base are subscribed to one another.

### Manual over-the-air subscription

- 1 With your system idle and your headset undocked, double press the subscription button on the base. The subscription light will flash green and red.
- 2 Press the volume up button on the headset for three seconds until the headset LED turns solid white. When the subscription light on the base remains solid green, the headset and base are subscribed to one another.

**NOTE** If the base subscription LED goes solid red, after flashing red/green, the subscription attempt has failed and should be repeated.

### **End Subscription**

If the base is in subscription mode and you want to stop the base from searching for a headset, press the subscription button again. The subscription light will be solid red for four seconds and then go to its previous state.

### **Subscription and Security Levels**

Your Savi 700 Series headset system (v28 or later) supports DECT Forum recommendations for "Enhanced Security". Products with Enhanced Security are marked with the DECT Forum security logo on the base.

Both your headset and headset base are compatible with older (prior to v28) headset bases and headsets supporting older versions of DECT. Below is helpful information if you plan to use Enhanced Security and older DECT components together.

If your Enhanced Security headset or headset base is subscribed with an older headset or headset base, the resulting security level for the mixed headset and base combination will be set to the level of the older headset for all calls. This is because older system components are not able to support Enhanced Security.

All subscription details above apply when subscribing an Enhanced Security headset to an older base, or visa versa, however there are unique system alerts indicating that the system is changing the security level from Enhanced Security to the older version of security.

#### **If an older headset is subscribed to an Enhanced Security Base:**

- The subscription LED (lower left) will flash GREEN 3 times followed by YELLOW 2 times. This flash pattern repeats 2 times.

#### **If an Enhanced Security headset is subscribed to an older base:**

- The Enhanced Security headset will play a security notification tone.
- The mono-colored LED on the headset will flash 3 times, then 2 times. This flash pattern is repeated 2 times.

### **Disabling Over-the-Air Subscription**

The Savi system ships with the over-the-air subscription enabled. In a multi-shift environment, you may want to disable this mode of subscription. You can enable/disable over-the-air subscription with the base subscription button or with the Plantronics Hub.

While your system is idle, hold the subscription button and the PC phone button down simultaneously until the PC phone button LED flashes. It will flash red for 4 seconds when over-the-air subscription has been disabled or green for 4 seconds when enabled.

You can also enable/disable over-the-air subscription with the Plantronics Hub. Go to Start > Programs > Plantronics > Plantronics Hub > Settings > Wireless > Over-the-Air-Subscription.



### Base Subscription Button LED

Base Subscription LED	Base Status
Flashes green and red	Primary headset subscription mode
Solid green	Primary headset subscribed to base
Solid yellow	Active conference call with guest headsets
Solid red	No headset subscribed

### Set the Range

Changing the range can help with desk phone/PC audio quality, improve user density or restrict range of users.

You can change the range using the subscription button on the base. With the system idle, press the subscription and desk phone buttons for three seconds. The desk phone button will flash green for high range. If you press the subscription button again for three seconds, the desk phone button will flash yellow for medium range. If you press the subscription button again for three seconds, the desk phone button will flash red for low range.

Setting	Range
High	up to 350 ft.
Medium	up to 150 ft.
Low	up to 50 ft.

You can also set the range using the Plantronics Hub. Go to Start > Programs > Plantronics > Plantronics Hub > Settings > Wireless > Range.

### Bluetooth Pairing Button

#### Auto Connect Feature

Once you have paired and connected your mobile phone to the base, the base will automatically connect to it when you are in range of your base.

You can manually disconnect your mobile phone from the base by short pressing the base Bluetooth pairing button when it is solid blue. However if you do this, you must manually reestablish a connection with your mobile phone by pressing the base Bluetooth button again, before the auto connection feature will resume.

You may customize this feature by using the Plantronics Hub by going to Start > Programs > Plantronics > Plantronics Hub > Settings > Wireless > Auto Connect to Mobile Phone.

# Daily Use

## Incoming Calls

### Answer a Call

The easiest way to answer an incoming call from the desk phone, mobile phone, or computer is to press the headset call button when you hear an incoming call.

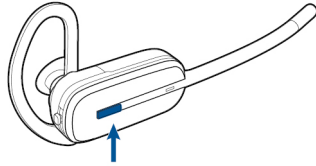

Alternatively, you can answer an incoming call by pressing the base button for the line that is ringing.

**NOTE** If you don't have remote call control through a lifter (HL10) or cable (EHS), manually remove desk phone handset before each call.

**NOTE** Remote answer/end capability for the PC is a software feature and dependent on a compatible softphone. If you do not install the software or don't have a compatible softphone, you will need to press the headset call button first then answer the call using the softphone application. Visit [plantronics.com/software](http://plantronics.com/software) for more information.

### Answer a Second Incoming Call With Your Headset

If you are on a call and a second call comes in from one of the other devices, you can flash (answer) to the second call by pressing the headset volume button up or down for 1.5 seconds. This will put the first call on hold while answering the incoming call.

You can flash to answer multiple incoming calls from the PC, however only one call is supported at any given time on the mobile phone or desk phone. You will need to manage multiple calls on the desk phone or mobile phone on the devices themselves.

### Answer a Call While Listening to Music or Audio

To answer a call while listening to music or audio, press the headset call button (or base computer button) to answer the incoming call. When the call is complete you may need to restart your media player application.

If Plantronics Software is installed and running you may experience enhanced behavior: When listening to music or audio on a supported media player and a call comes in, the system can pause the music when you answer your call and resume the music when your call is over. The Media Player Action on incoming call settings are defined in the setting tab under "Softphone of Plantronics Hub software."

### Answer a Call with Your Mobile Phone

If you answer an incoming mobile call using the answer button on the mobile phone, the audio will remain in the phone. If you answer an incoming call using the headset or base, the audio will be in the headset.

### Reject a Mobile Call

When you receive an incoming mobile phone call, the mobile button on the base will flash green.

To reject the call, hold the base mobile button down for 3 seconds.

## Outgoing Calls

### Place a desk phone call

- 1 While wearing your headset, short press the base desk phone button.

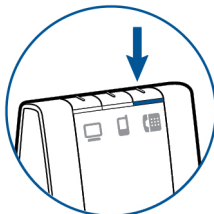

**NOTE** If you don't have remote call control through a lifter (HL10) or cable (EHS), manually remove desk phone handset before each call.

- 2 Dial a call using your desk phone.
- 3 To end the call, press the headset call button and hang up the handset.

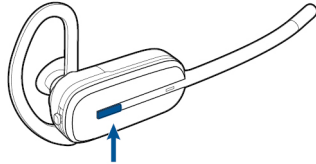

Alternatively, you can place an outgoing call by pressing your headset call control button, then dialing from your desk phone if the deskphone is the default line.

#### Place a mobile phone call

- 1 While wearing your headset, short press the base mobile button.

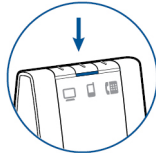

**NOTE** If you place the mobile phone call without pressing the base mobile button first, the audio will stay on the mobile phone. If you would like to transfer the audio to your headset, short press the mobile base button.

- 2 Dial a call from your mobile phone.
- 3 End the call by pressing the headset call control button.

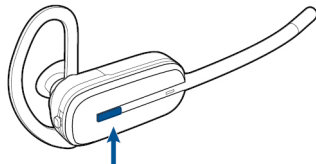

#### Hands-free dialing

To enable hands-free dialing, install the Plantronics software. Once installed, go to Start > Programs > Plantronics > Plantronics Hub > Settings > Wireless > Initiate Mobile voice commands. For hands-free dialing, initiate the mobile call from the base by pressing the base mobile button. Your mobile phone will prompt you for voice commands.

Alternatively, you can dial a number from your mobile phone and then press the base mobile button to move the audio to the headset.

#### Place a Softphone Call

- 1 While wearing your headset, short press the base computer button.

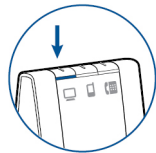

- 2 Dial a call from your computer softphone.
- 3 End the call by pressing the headset call control button.

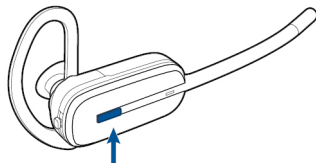

### Softphone Compatibility

Remote call answer/end from the headset is available for compatible softphones with no additional steps by the user except Skype™. For a list of compatible softphones visit [plantronics.com/us/support/software-downloads/](http://plantronics.com/us/support/software-downloads/). For Skype support, follow the steps below.

- 1 Skype will display the following message during the install of Plantronics Unified Runtime Engine "PlantronicsURE.exe wants to use Skype". Choose "Allow Access" to connect.
- 2 You can also check Savi W740 Skype connection status by going to Skype and checking the Tools > Options > Advanced > Advanced Settings > "Manage Other Programs Access" setting.

### Multi-Phone Status

Multi-Phone Status (MPS) is supported for Microsoft Lync/Office Communicator and Skype. When a call is placed or received on your deskphone or mobile phone that is paired to a Plantronics Bluetooth headset, your presence in Microsoft Lync/Office Communicator and Skype will be automatically updated to reflect a busy status. When your call is terminated, your presence will return to its previous state.

### Mobile Phone and Headset Audio

If you answer an incoming mobile call using the answer button on the mobile phone, the audio will remain in the phone. If you answer an incoming call using the headset or base, the audio will be in the headset.

If the mobile phone audio is in the mobile phone, you can move the audio to the headset by short pressing the base mobile button when the LED is off. To move the mobile phone audio from the headset back to the mobile phone, hold the base mobile button for 3 seconds until the solid green LED turns off. The audio will be pushed back to the mobile phone.

### Listening to Other PC Audio

Ensure the PC audio you are trying to listen to is being routed to your Savi 7xx device.

- 1 Go to "Control Panel" and open "Sounds and Audio Devices."
- 2 In the "Audio" tab select **Savi 7xx** under "Sound Playback."
- 3 Launch the application that contains the PC audio and play.

### Combine Audio From Any Two Lines or Channels

You can combine the audio of any two devices by simultaneously holding the base buttons of any two of the three base buttons until the LEDs become solid green. This is useful as a mini-teleconference call.

### Conference Up to Three Additional Headsets

While on a call you can subscribe up to three additional headsets to your base for conferencing.

#### Join a conference call

- 1 While the base has an active link, place the guest headset into primary user's charge cradle (this connects the headset to the base).  
When the base subscription light stops flashing green and yellow and remains yellow, the primary headset/user will hear a tone indicating a guest wishes to join the call.
- 2 Press the primary user's call button to accept the guest headset within ten seconds. Otherwise the request is terminated and the guest will hear an error tone in their headset.

**NOTE** To connect a guest headset that is of different variety than the primary headset, short press the base subscription button while the base has an active link. Next, press the guest headset volume up button until the indicator light turns on. When the base subscription LED stops flashing green and yellow and remains solid yellow, the request to join will be heard in the primary user's headset and the primary user will have to press their call button within 10 seconds to accept the guest.

#### Exit a conference call

Guests headsets can remain as guests through multiple calls.

To remove a guest headset, press the guest headset's call button or dock the primary user's headset in the charge cradle.

A single tone in the master headset will be heard as each guest leaves the call.

#### **View guest headsets**

As you add headsets to the base, an additional headset icon will appear in the Plantronics Hub screen with a number from 1 to 3 indicating the number of additional headset subscribed to the base. The first headset is the primary user's headset and the number inside the next headset is the number of guest headsets subscribed to the base. The following example shows one primary headset with 2 guest headsets conferenced in.



#### Conferencing Additional Headsets and Security Levels

Your Savi 700 Series headset system (v28 or later) supports DECT Forum recommendations for Enhanced Security. Products with Enhanced Security are marked with the DECT Forum security logo on the base.

Both your headset and headset base are compatible with older (prior to v28) headset bases and headsets supporting older versions of DECT. Below is helpful information if you plan to use Enhanced Security and older DECT components together.

If your Enhanced Security headset or headset base is conferenced with an older headset or headset base the resulting security level for the mixed headset and base combination will be set to the level of the older version of DECT for all calls. This is because older system components are not able to support Enhanced Security.

All subscription details above apply when conferencing an Enhanced Security headset to an older base, or visa versa, however there are unique system alerts indicating that the system is changing the security level from Enhanced Security to the older version of security.

#### **If an older headset is subscribed to an Enhanced Security Base:**

- The subscription LED (lower left) will flash GREEN 3 times followed by YELLOW 2 times. This flash pattern repeats 2 times.

#### **If an Enhanced Security headset is subscribed to an older base:**

- The Enhanced Security headset will play a security notification tone.
- The mono-colored LED on the headset will flash 3 times, then 2 times. This flash pattern is repeated 2 times.

# Advanced Use

Plantronics Hub resides on your computer system and allows you to customize your settings and get visible status of your Plantronics audio device on your desktop. Plantronics Hub provides users with an easy way to change device and software settings and install software and firmware updates.

This section provides information specific to Savi 700 Series products, with an emphasis on covering all of the available settings for your Savi 700 headset system.

Plantronics Hub has its own comprehensive Plantronics Hub User Guide which can be found: [www.plantronics.com/us/product/plantronics-hub-desktop/#support](http://www.plantronics.com/us/product/plantronics-hub-desktop/#support) .

## Install Plantronics Hub

To access the Plantronics Hub, load Plantronics software by visiting [plantronics.com/us/support/software-downloads/](http://plantronics.com/us/support/software-downloads/) and click on download button.

## Start Hub

To start Hub, click Start > Programs > Plantronics > Hub

## Hub Tabs

When you first start Plantronics Hub the About Tab will be displayed. If you have at least one Plantronics device connected to your computer using a USB connector you will see an image of your device along with some information about that device. You will also see tabs across the top of the application that read "About", "Updates", "Settings", and "Help" which are described below.



### About Tab

Provides information about your connected device or devices; switch between devices or set primary device (pull down menu, upper left, appears when multiple devices present).

---

### Updates tab

Check for device firmware and Hub software updates; get information about updates when available, install as necessary

---

### Settings tab

Configure available settings for your device or devices, Hub software

---

### Help tab

Support, contact, and troubleshooting information and resources

---

## Hub Settings Options

	Feature	Settings	Default
<b>General (software)</b>	Ring location	Headset, Headset/PC	Headset only
	Maintain Headset to PC Radio Link	Active Only During Call/ Always Active	Active Only During Call
	Software Log Level Detail	Low/Med/High/Verbose	Low
	Metrics Collection to Help Improve Hub	Off/On	On
<b>General (Savi 700 Series)</b>	Default Phone Line	Deskphone/PC/Mobile	PC
	Auto Answer	Off / On	Off
	MS OC Lync Dial Tone	Off / On	On
	Audio Sensing	Off / On	On
	Second Inbound Call	Ring Continuously/Ring Once/Ignore	Ring Continuously
	Mute Reminder Volume	Default Volume/Low Volume /Off	Off

### **Ring Location**

This feature gives you the option to have the PC ringtone played on both the headset as well as the PC speaker.

When this feature is selected, the PC ringtone will be heard on both the PC speaker as well as the headset.

When this feature is not selected, the PC ringtone will only be heard on either the headset or the PC speaker based on how the PC audio has been set up.

### **Maintain Headset to PC Link**

This feature forces the radio link to the PC to stay active even after the call has ended. This can eliminate the need to re-establish the radio link when switching between PC audio applications.

### **Software Log Level Detail**

Adjust the level of detail captured in log files.

### **Metrics Collection to Help Improve Hub**

When selected, this will allow Plantronics to collect data on feature usage pattern. This information will only be used by Plantronics to improve the quality of our future software and hardware products.

**Default Phone Line for Outbound Calls**

Set the preferred phone line for outbound calls when you press the headset call control button. To change the default outbound line with the base see [Change your default outbound line](#).

**Auto Answer**

When enabled, this feature will configure your headset to automatically answer a call when it is removed from the charge cradle.

**Microsoft Office Communicator/Lync Dial Tone**

This feature enables/disables mobile phone voice commands for hands-free dialing with your mobile phone. When this is enabled, you will be prompted for voice commands by your mobile phone when a call is initiated with the base mobile button. This feature requires mobile phone support for voice commands.

If this feature is selected, when a PC radio link is established, Microsoft Office Communicator/Lync will assume the user is trying to place a VoIP call and provide a dial tone.

If this feature is not selected, when a PC radio link is established, Microsoft Office Communicator/Lync will sit idle.

**Audio Sensing**

Audio Sensing is a special feature supported by Plantronics wireless devices that can detect an audio signal at the USB port and automatically establish the radio link between the base and the wireless headset without the user having to press the call control button. When the Configure Lync Dial Tone parameter is set to On, every time the user presses the call control button, the Lync dial tone will be heard (assuming the user wants to make a softphone call). However, the user may have pressed the call control button to listen to PC music, etc., and does not want to hear the dial tone. In this case, if the user sets the Audio Sensing parameter to On, the radio link will be established automatically when any PC audio is detected at the USB port, thus eliminating the need for the user to press the call control button.

**Second Inbound Call**

When you are on a call and a second call comes in, this feature enables you to control the ring behavior for the second call. The options are for the call to *Ring Continuously* until answered (default), for the call to *Ring Once* and then be silent until answered, or for the call to be ignored completely if *Ignore Ring* is selected.

**Mute Reminder Volume**

Controls the volume of the tone to remind you your microphone is muted, or turn the mute tone off.



## Ring Tones and Volumes

Feature	Settings	Default
Desk Phone ringtone	Tone 1/Tone 2/Tone 3 Default/Low/Off	Tone 1 Default volume
Mobile Phone ringtone	Standard/Low/Off Tone 1/Tone 2/Tone 3 Default/Low/Off	Tone 2 Default volume
PC ringtone	Tone 1/Tone 2/Tone 3 Default/Low/Off	Tone 3 Default volume
System tone	Default/Low/Off	Default volume
Wearing Preference for Volume Control	No change/Left ear/ Right ear	No change
<b>NOTE</b> For Savi 740/745 models only		

### Desk Phone Ringtone

Select the ringtone and volume that your hear when your deskphone rings.

### Mobile Phone Ringtone

Select the ringtone and volume that your hear when your mobile phone rings.

### PC Ringtone

Select the ringtone and volume that your hear when your PC softphone rings.

### System Tone

Sets the volume of your computer's system tones.

### Wearing Preference (enabled for Savi 740/745 only)

Volume controls are oriented up/down for right-ear wearing; when switched to left-ear wearing the volume controls will be reversed. This setting allows for the reversal of the up/down volume orientation for left-ear wearing.

## Softphones and Media Players

Feature	Settings	Default
Media Player Action on Incoming Call	Pause and Resume/No Action	Pause and Resume
Selected Softphones	Selected/Deselected	All selected
PC ringtone	Selected/Deselected	All selected

### Media Player Action on Incoming Call

Defines action for your media player when listening to media and an incoming call is received.

### Selected Softphones

Defines which softphones are enabled for Hub interoperability. *Avaya one-X Communicator, Avaya one-X Agent, Avaya IP Softphone, Avaya IP Agent, Cisco IP Communicator, Cisco UC Clients (CSF), NEC SP350, Cisco WebEx.*

### Selected Media Players

Defines which media players are enabled for Hub interoperability. *Winamp, Windows Media Player, iTunes.*

Presence

Feature	Settings	Default
Auto Update my Presence (MS OC/ Lync, Skype)	Off/On	Off

### Auto Update my Presence for Microsoft OC/Lync and Skype

Update your Microsoft Office Communicator / Lync and Skype presence status when you are on a phone call with your mobile phone, deskphone, or Plantronics supported softphone. Plantronics plugin for Lync must also be installed for this feature to work.

Wireless

Feature	Settings	Default
Auto Connect to Mobile Phone	Off/On	On
Auto Connect	Off/On	On
Bluetooth Enabled	Off/On	On
Over the Air Subscription	Off/On	On
Initiate Mobile Voice Commands	Off/On	Off
Range	Low/Med/High	High
PC audio Bandwidth	Narrowband/Wideband	Wideband
Desk phone Audio Bandwidth	Narrowband/Wideband	Wideband
Streaming Audio	Off/On	On

### Auto-Connect to Mobile Phone

Automatically reconnect the Savi base to your paired mobile phone when the phone comes within range of the base unit.

### Bluetooth Enabled

Connect wirelessly to and pair with your mobile phone. When disabled, your headset will not be able to connect to your mobile phone wirelessly.

### Over the Air Subscription

This feature allows a headset to be subscribed to the base without physically docking the headset. It is required when conferencing multiple models of Plantronics headsets.

For more on subscription, see Base Subscription Buttons. For more on headset guest conferencing, see Conference Up to Three Additional Headsets.

### Initiate Mobile Voice Commands

Sets whether or not you can put a paired mobile phone in voice command mode by pressing the mobile phone button on the base.

### Range

Changing the range can help with desk phone/PC audio quality, improve user density or restrict range of users. To change the range with the base see Setting the Range.

Setting	Range
High	up to 350 ft.
Medium	up to 150 ft.
Low	up to 50 ft.

### PC Audio Bandwidth

Wideband audio delivers heightened speech clarity and life-like fidelity, but consumes more battery power, resulting in reduced talk time.

### Desk phone Audio Bandwidth

Wideband audio delivers heightened speech clarity and life-like fidelity, but consumes more battery power, resulting in reduced talk time.

### Streaming Audio

Stream music, podcasts, and other types of audio to your headset. If you are not streaming audio to your headset, disable this feature to conserve battery life.

## Advanced

Feature	Settings	Default
Anti-Startle (Plantronics Enhanced)	Off/On	Off
Anti-Startle (G616)	Off/On	Off
Audio Limiting	Off/80dB/85dB	Off
Hours on phone per day	Off/2/4/6/8	Off

### Anti-Startle (Plantronics Enhanced)

Plantronics enhanced anti-startle goes beyond G616, and provides advanced hearing protection against sudden loud sounds. When Anti-Startle is SELECTED, the system identifies and eliminates sudden loud sounds and rapidly reduces them to a comfortable level. When Anti-startle is NOT SELECTED, the headset limits sound levels at 118 dBA to protect your hearing.

**Anti-Startle (G616)**

G616 Acoustic Limiting provides additional hearing protection against acoustic shock. When G616 Acoustic Limiting is SELECTED, the system provides additional acoustic shock protection. Sound levels are limited to 102 dBA as recommended in the G616: 2006 guideline issued by the Australian Communications Industry Forum (ACIF). When G616 Audio-Limiting is NOT SELECTED, the headset limits sound levels at 118 dBA to protect your hearing.

**Audio Limiting**

Audio Limiting provides advanced hearing protection for daily noise exposure. When Audio-Limiting is SELECTED, the system monitors and controls sound to ensure audio levels do not exceed 80 dBA or 85 dBA (whichever is selected) specified by current and imminent EU legislation. When Audio-Limiting is set to NOT SELECTED, the headset limits sound levels at 118 dBA to protect your hearing.

**Hours on Phone Per Day**

Optimize the use of Automatic Acoustic Level (AAL) related parameters such as Time Weighted Average (TWA) by selecting the value that best represents your typical use of this device.

**Plantronics Update Manager**

All required software and firmware for Savi system can be remotely updated when updates are available. Start Plantronics Update Manager from Windows Start Programs menu > Programs > Plantronics > Plantronics Update Manager to change settings such as automatic or manual check for updates.

**Check for Updates Automatically**

By enabling this check box, you will activate a periodic automatic check for available software and firmware updates.

**Check for Updates Now**

You can choose to check for available software and firmware updates at any time by clicking on the Check For Updates Now button in Update Manager by clicking on the Start menu > Programs > Plantronics > Plantronics Update Manager.

**Install Checked Updates**

Following an AUTOMATIC or MANUAL CHECK FOR UPDATES, this field will be populated with any applicable software updates and the INSTALL CHECKED UPDATES will begin installation.



*Avoid touching the contacts at the rear of the unit unnecessarily. If operation is interrupted by a static event, power-cycle the product to restore normal functions.*

## **NEED MORE HELP?**

**[plantronics.com/support](http://plantronics.com/support)**

### **Plantronics, Inc.**

345 Encinal Street  
Santa Cruz, CA 95060  
United States

### **Plantronics BV**

South Point Building C  
Scorpius 140  
2132 LR Hoofddorp

© 2011 Plantronics, Inc. All rights reserved. Plantronics, the logo design, HLT0, Savi, Sound Innovation are trademarks or registered trademarks of Plantronics, Inc. Windows is a registered trademark of Microsoft Corporation. Nortel is a trademark of Nortel Networks. Skype is a registered trademark of Skype Limited. All other trademarks are property of their respective owners.

Patents: U.S. 7,633,963; D599,331; D582,901; D603,372; D589,031; China ZL200830005437.x; CN301013095D; EM 000873823-0004; 001151336-0002; 000873823-0002; Taiwan D127496; D127399

86331-06 (04.15)