

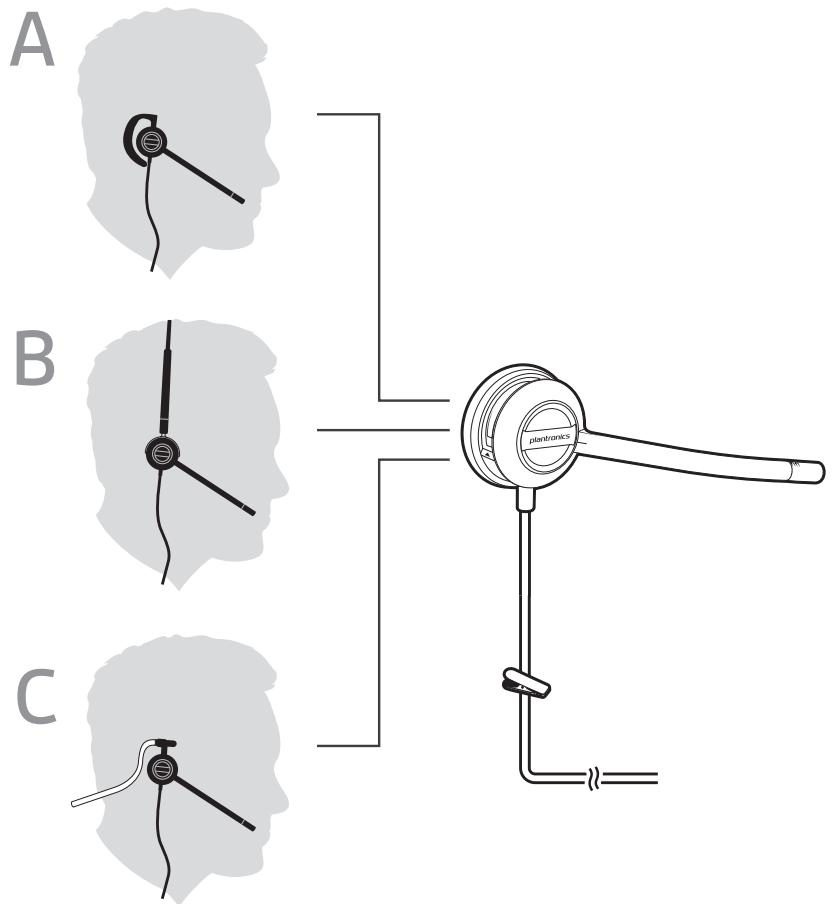

ENCOREPRO 540  
ENCOREPRO 540 DIGITAL

HW540/HW540D

**plantronics**®



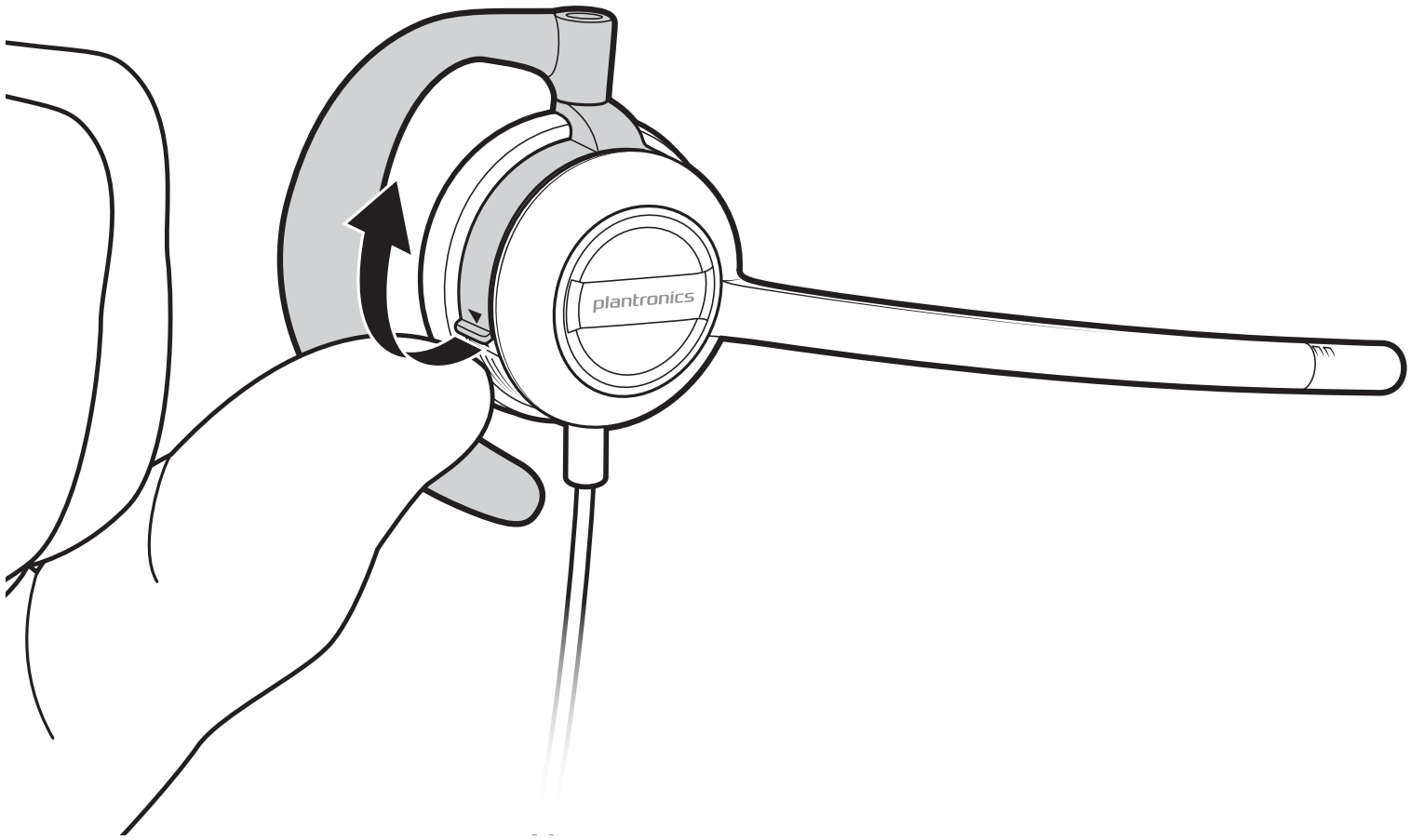

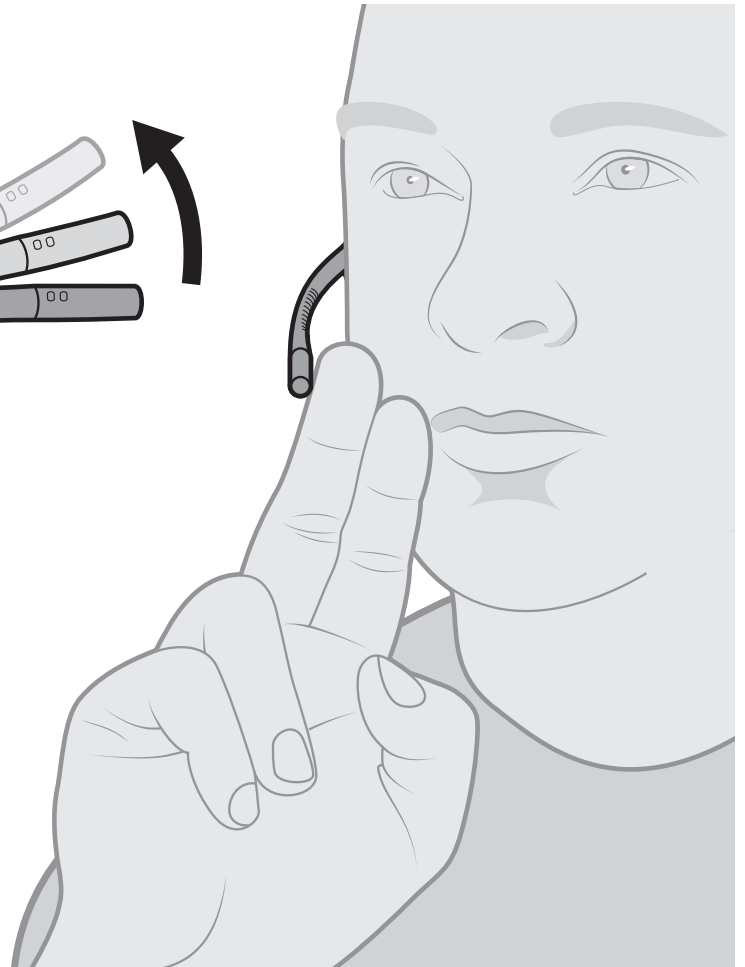
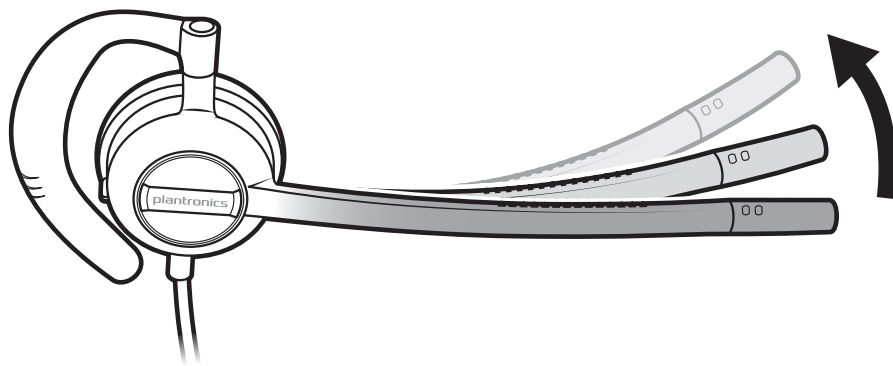

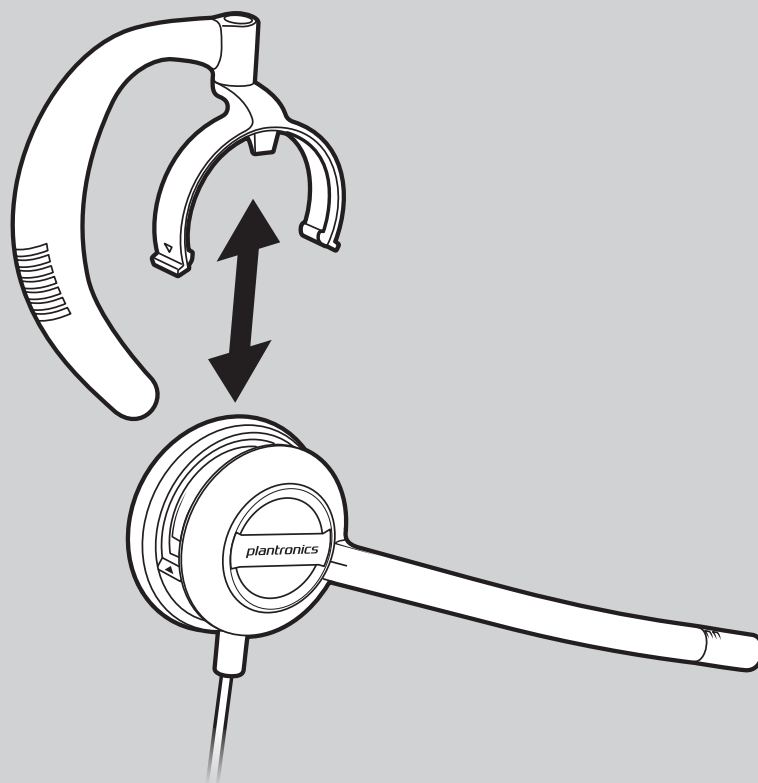

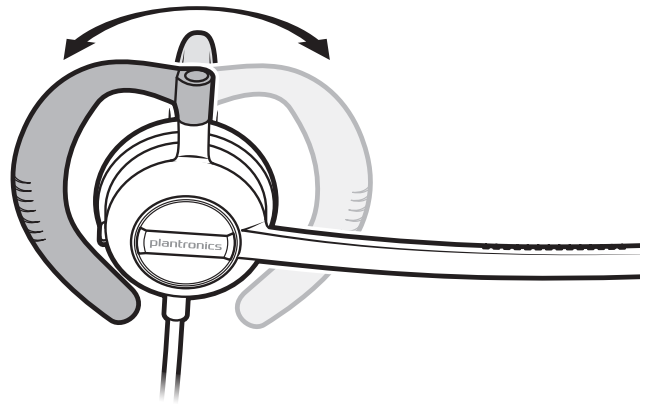
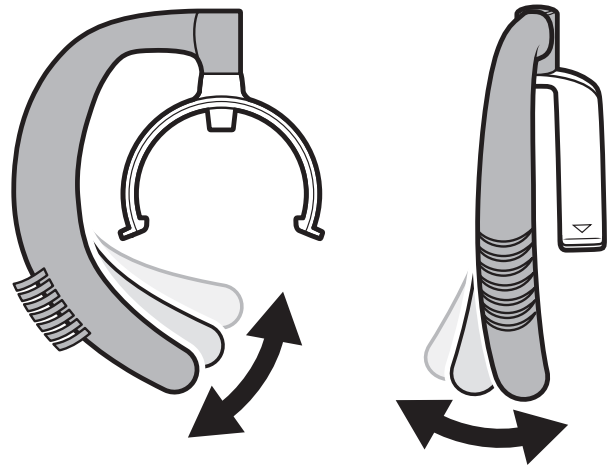
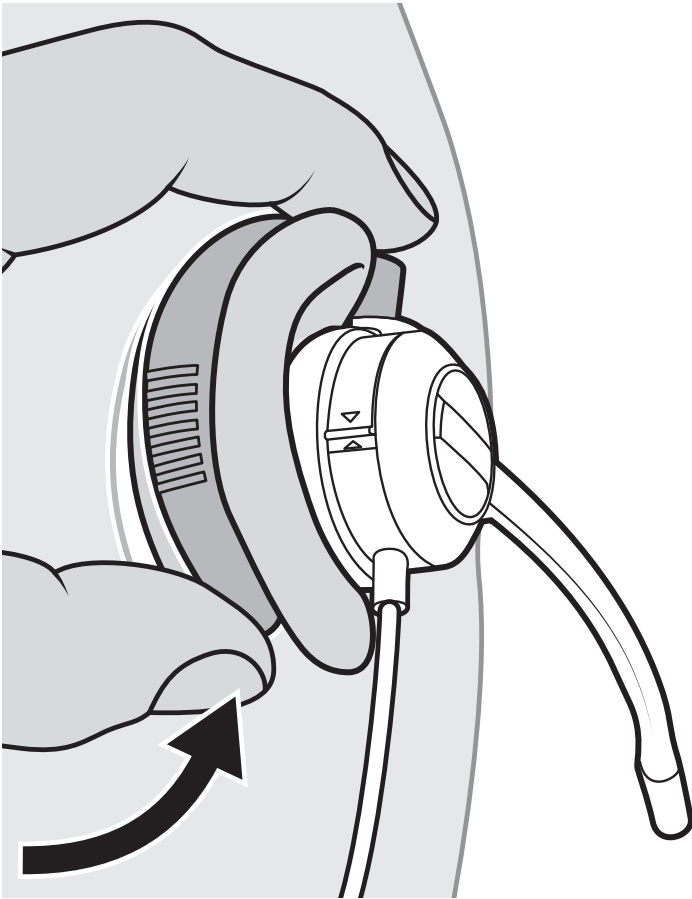



L



R

 [plantronics.com/documentation](http://plantronics.com/documentation)

 [plantronics.com/support](http://plantronics.com/support)

**Plantronics, Inc.**

345 Encinal Street  
Santa Cruz, CA 95060  
United States

**Plantronics BV**

South Point Building C  
Scorpius 140  
2132 LR Hoofddorp  
Netherlands

©2016 Plantronics, Inc. EncorePro and Plantronics are trademarks of Plantronics, Inc. registered in the US and other countries. All other trademarks are the property of their respective owners.

Patents: US D717,767; BR 302014001163-4; CN ZL201430055816.5;  
CO 8123; EM 002426361; IN 261143; MX 43922; TW D167521; patents pending  
206660-02 03.16



Recyclable where  
facilities exist