

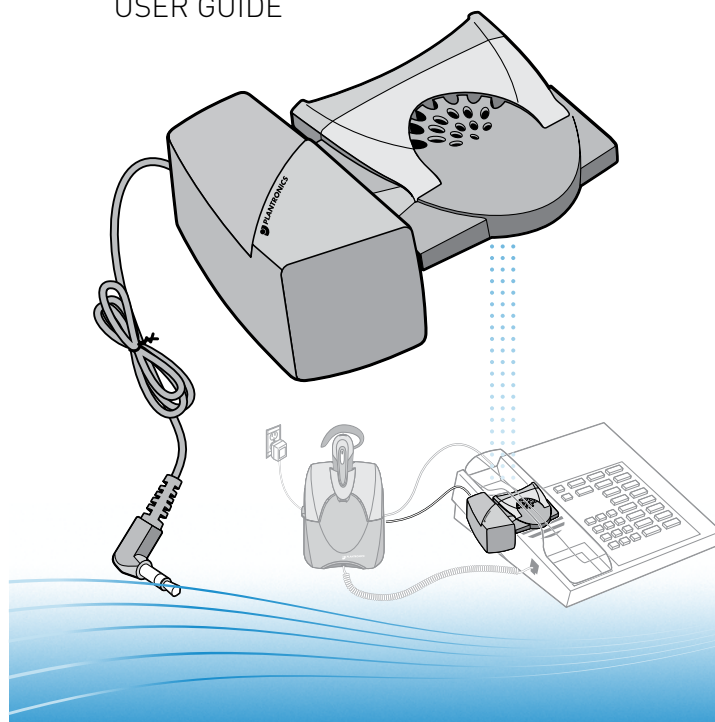

HL10 Handset Lifter Accessory

USER GUIDE



COMPONENTS OF THE HL10 HANDSET LIFTER ACCESSORY

TOP VIEW

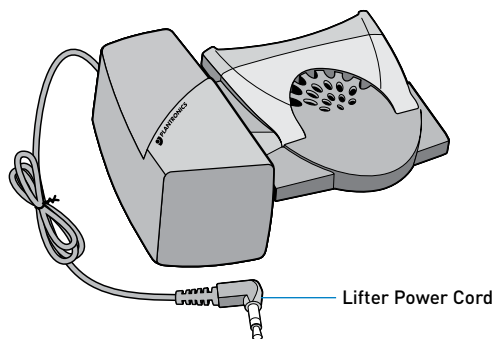

UNDERSIDE VIEW

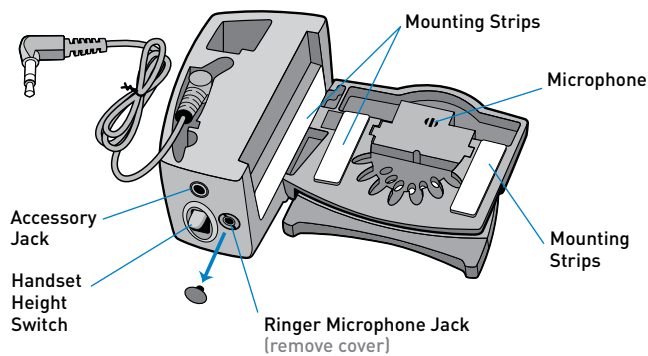

EXTENDER ARM (if required)

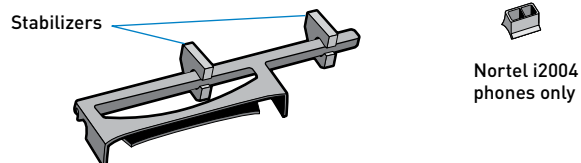

RINGER MICROPHONE (if required)

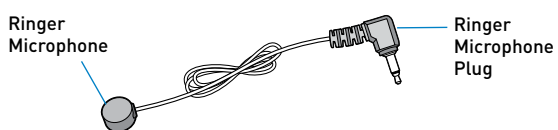

The HL10 Handset Lifter Accessory is designed to be used with a Plantronics Headset System. Please read these instructions to setup and use your HL10. Make sure your Plantronics Headset Wireless System is fully charged.

IMPORTANT: Follow setup instructions carefully.

SETTING UP THE HL10

IMPORTANT: Do not remove the mounting strip covers until all adjustments have been made.

1. Connect the Lifter Power Cord to the Accessory Jack on the Plantronics amplifier. Be sure to press firmly for a tight fit.
2. Remove the handset from the cradle (or telephone base).

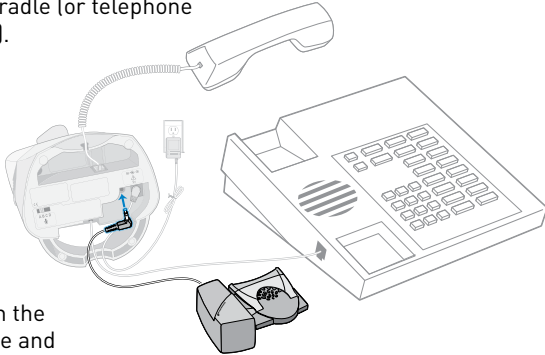

3. Clean the cradle and speaker areas of the phone and replace the handset.
4. Temporarily, place the HL10 on the phone under the handset and hold in place. The top edge of the lifter should touch the earpiece of the handset when the handset is placed in the cradle.

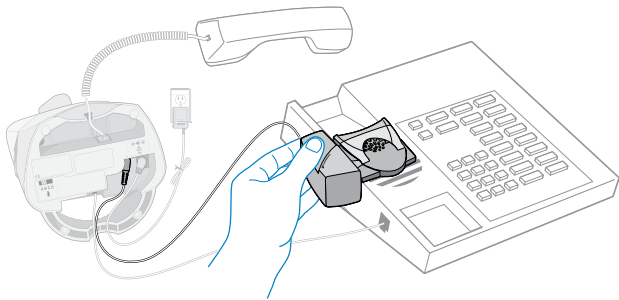

5. Verify that the microphone on the HL10 is located above the telephone ringer speaker. If not, you will need to attach the Ringer Microphone.

ADJUSTING THE HL10 FOR YOUR TELEPHONE

The HL10 raises the handset to three heights and angles by sliding the Handset Height Switch on the back of the HL10.

1. Begin with the Handset Height Switch in the lowest position.
2. While holding the HL10 on the telephone base and wearing your headset, place the handset on the HL10.

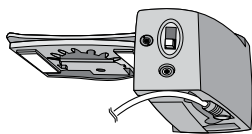

3. Press the talk button on the headset to lift the handset from the cradle. Listen for a dial tone.

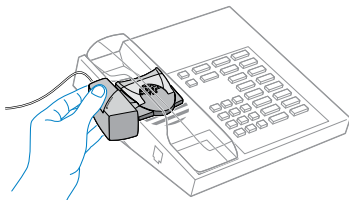

4. Press the talk button again to lower the handset and disconnect.

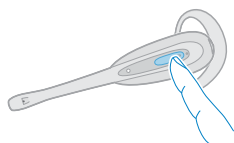

NOTE: If the HL10 does not lift the handset far enough to go off hook and return to the cradle easily, slide the Handset Height Switch up to another position.

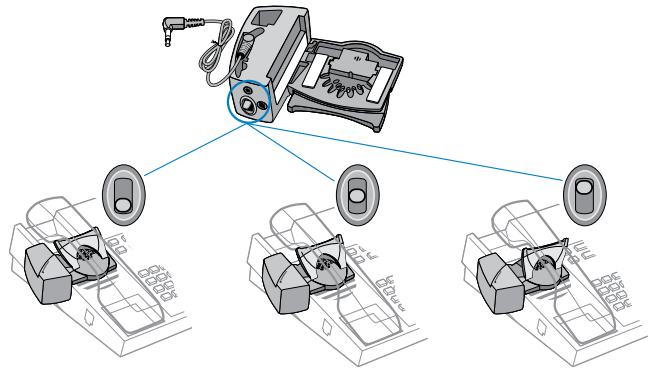

If the handset falls off the lifter, move the Handset Height Switch down. The Stabilizers on the Extender Arm (see below) can help steady the handset for more reliable operation.

NOTE: If your phone has an adjustable height, a lower setting may improve the performance of the HL10.

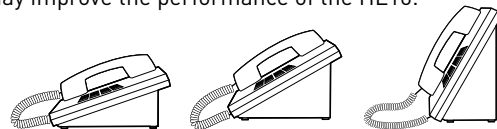

If the handset still does not lift and lower smoothly, your telephone may require the Extender Arm accessory.

ATTACHING THE EXTENDER ARM (IF REQUIRED)

The Extender Arm is intended to increase the distance from the HL10 to the earpiece of the handset. The Stabilizers can be shifted to the left or right to improve the stability of the handset on the HL10.

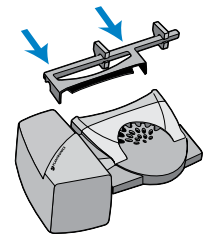

1. Slide the Extender Arm onto the HL10.
2. Position the Stabilizers on the outsides of the handset to gently grip the phone.
3. Read "Adjusting the HL10 for Your Telephone" to determine the correct HL10 height.

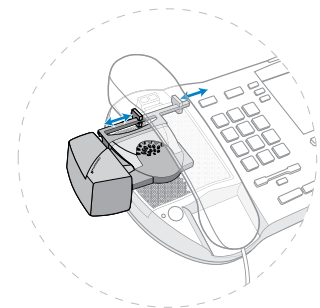

MOUNTING THE HL10 IN A PERMANENT POSITION

Once you have determined the best position for the Handset Height Switch, you can mount the HL10 on your telephone base.

1. Remove the protective covers from the mounting strips on the underside of the HL10.

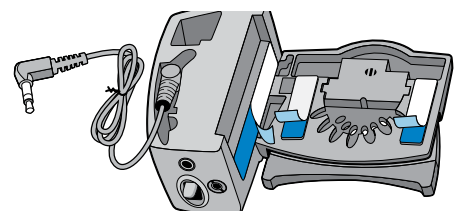

NOTE: If the side of the phone is curved, the protective cover on the side can be left on to improve the fit.

- Gently, place the HL10 into the position you have identified. Test that the lifter works.
- Once you have located the appropriate position, firmly press down on the top of the HL10 to attach the lifter to the telephone base.

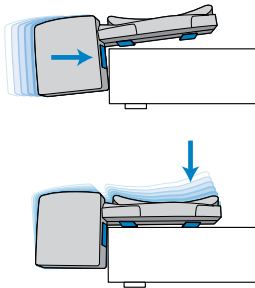

NOTE: Use a rolling motion to attach the lifter.

- Place the handset on the HL10.

MAKING AND RECEIVING CALLS

While wearing your headset, press the talk button to activate the HL10. When you hear a dial tone, use the telephone key pad to dial the number. To end the call, press the talk button again. The HL10 will return the handset to the cradle and disconnect the call.

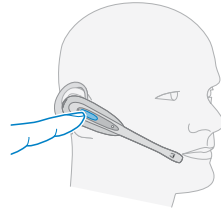

If your headset does not beep when the phone rings, you may need to adjust the ringer on your phone.

- For best results, choose a traditional ring pattern on your phone.
- Set the telephone ring volume at mid range.
- If necessary, try different settings of ring pattern and volume until the headset beeps when the phone rings.

If your headset still does not ring, attach the Ringer Microphone Extension to your HL10 and place the Ringer Microphone over the ringer speaker of your phone.

USING THE RINGER MICROPHONE EXTENSION (IF REQUIRED)

If the HL10 microphone is not located above the ringer speaker on your phone, you must install the optional Ringer Microphone Extension.

- Remove the cover from the Ringer Microphone Jack on the HL10.
- Connect the Ringer Microphone plug to the Ringer Microphone Jack.

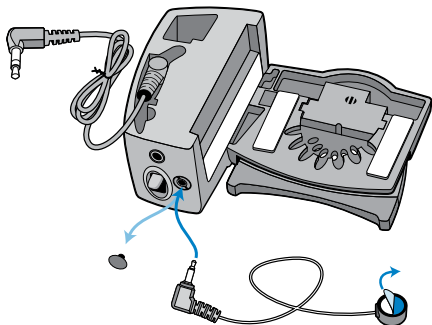

- Place the Ringer Microphone over the ringer speaker on the telephone. You should hear a beep in the headset when you receive a call.
- Remove the protective cover from the mounting tape and attach the Ringer Microphone to the telephone ringer speaker.

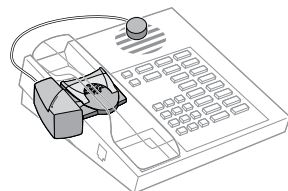

IMPORTANT SAFETY INFORMATION

- Read all instructions before using.
- The intended purpose of this HL10 Handset Lifter Accessory is to lift and lower the telephone handset in conjunction with Plantronics amplifiers manufactured for use with the HL10. It should not be used for any other purpose.
- Modification of the product will void the warranty.
- Do not allow anything other than the telephone handset to rest on this product or locate it in an area where normal operation can be hampered. Additional weight will prevent the lifter from working.

⚠ WARNINGS

- When using telephone equipment and accessories, basic safety precautions should be taken to reduce risk of fire, electric shock, and injury to persons.
- Keep fingers and other objects clear of the lifting pad.
- To reduce risk of electric shock, do not disassemble this product. Contact the Plantronics Technical Assistance Center when service or repair work is required.
- Unplug the lifter from the amplifier or the amplifier from the power source (wall outlet) before cleaning. Do not use liquid cleaners or aerosol cleaners. Use a damp cloth for cleaning.

WARRANTY AND SERVICE

LIMITED WARRANTY

- This warranty covers defects in materials and workmanship of this Plantronics Product manufactured, sold, or certified by Plantronics which was purchased and used in the United States and Canada.
- This warranty lasts for one year from the date of purchase of the Product.
- This warranty extends to you only if you are the end user with the original purchase receipt.
- We will, at our option, repair or replace the Product that does not conform to the warranty. We may use functionally equivalent reconditioned/refurbished/remanufactured/pre-owned or new Products or parts.
- To obtain service in the US, contact Plantronics at [800 544 4660 ext. 5538](tel:8005444660) and in Canada call [800 540 8363](tel:8005408363). If you need additional information, please contact our service centers at the numbers provided.
- THIS IS PLANTRONICS' COMPLETE WARRANTY FOR THE PRODUCT.**
- This warranty gives you specific legal rights, and you may also have other rights which vary from state to state or province to province. Please contact your dealer or our service center for the full details of our limited warranty, including items not covered by this limited warranty.

The **PLANTRONICS TECHNICAL ASSISTANCE CENTER (TAC)** is ready to assist you! Dial [800 544 4660 ext. 5538](tel:8005444660) or visit the support section of our website at www.plantronics.com.

For accessibility information, also call the Technical Assistance Center.



www.plantronics.com

345 ENCINAL STREET | SANTA CRUZ, CA 95060 USA | PHONE: 800 544 4660

© 2001-2006 Plantronics, Inc. All rights reserved. Plantronics, the logo design, and Sound Innovation are trademarks or registered trademarks of Plantronics, Inc.

Patents U.S. D469,756; Australia 147229; France 651,857-651,865; Germany 40108524.4; GB Regd.Des.No. 2104923

Printed in USA

71233-01 (3/06)