

# DrayTek

## VigorAP 800

802.11n Access Point



## Quick Start Guide

V1.0

# VigorAP 800 Access Point

## Quick Start Guide

Version: 1.0

Date: 15/04/2010

### Warranty

We warrant to the original end user (purchaser) that the router will be free from any defects in workmanship or materials for a period of one (1) year from the date of purchase from the dealer. Please keep your purchase receipt in a safe place as it serves as proof of date of purchase. During the warranty period, and upon proof of purchase, should the product have indications of failure due to faulty workmanship and/or materials, we will, at our discretion, repair or replace the defective products or components, without charge for either parts or labor, to whatever extent we deem necessary to restore the product to proper operating condition. Any replacement will consist of a new or re-manufactured functionally equivalent product of equal value, and will be offered solely at our discretion. This warranty will not apply if the product is modified, misused, tampered with, damaged by an act of God, or subjected to abnormal working conditions. The warranty does not cover the bundled or licensed software of other vendors. Defects which do not significantly affect the usability of the product will not be covered by the warranty. We reserve the right to revise the manual and online documentation and to make changes from time to time in the contents hereof without obligation to notify any person of such revision or changes.

### European Community Declarations

Manufacturer: DrayTek Corp.  
Address: No. 26, Fu Shing Road, HuKou Township, HsinChu Industrial Park, Hsin-Chu, Taiwan 303  
Product: VigorAP 800

DrayTek Corp. declares that VigorAP 800 is in compliance with the following essential requirements and other relevant provisions of R&TTE Directive 1999/5/EEC.

The product conforms to the requirements of Electro-Magnetic Compatibility (EMC) Directive 2004/108/EC by complying with the requirements set forth in EN55022/Class B and EN55024/Class B.

The product conforms to the requirements of Low Voltage (LVD) Directive 2006/95/EC by complying with the requirements set forth in EN60950-1.

### Federal Communication Commission Interference Statement

This equipment has been tested and found to comply with the limits for a Class B digital device, pursuant to Part 15 of the FCC Rules. These limits are designed to provide reasonable protection against harmful interference in a residential installation. This equipment generates, uses and can radiate radio frequency energy and, if not installed and used in accordance with the instructions, may cause harmful interference to radio communications. However, there is no guarantee that interference will not occur in a particular installation. If this equipment does cause harmful interference to radio or television reception, which can be determined by turning the equipment off and on, the user is encouraged to try to correct the interference by one of the following measures:

- Reorient or relocate the receiving antenna.
- Increase the separation between the equipment and receiver.
- Connect the equipment into an outlet on a circuit different from that to which the receiver is connected.
- Consult the dealer or an experienced radio/TV technician for help.

This device complies with Part 15 of the FCC Rules. Operation is subject to the following two conditions:

- (1) This device may not cause harmful interference, and
- (2) This device may accept any interference received, including interference that may cause undesired operation.

This product is designed for 2.4GHz WLAN network throughout the EC region and Switzerland with restrictions in France.



# 1

## Package Content



Quick Start Guide

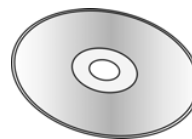

CD

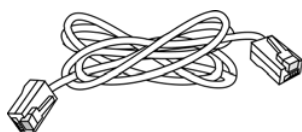

RJ-45 Cable (Ethernet)

The type of the power adapter depends on the country that the router will be installed:

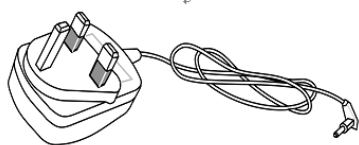

UK-type power adapter

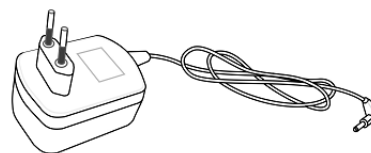

EU-type power adapter

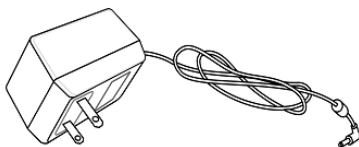

USA/Taiwan-type power adapter

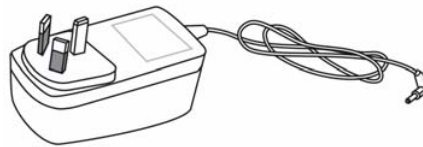

AU/NZ-type Power Adapter

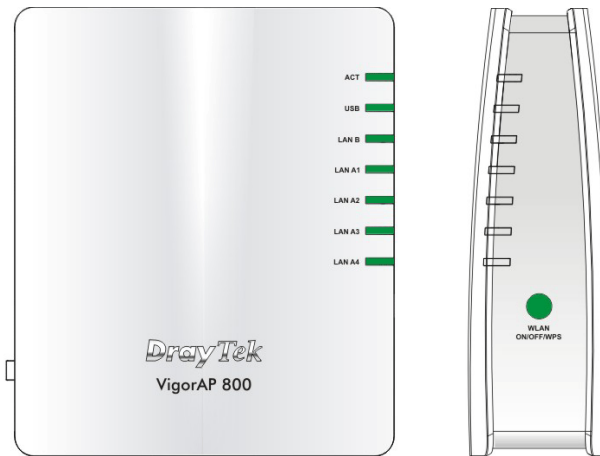

# 2

## Descriptions of Components

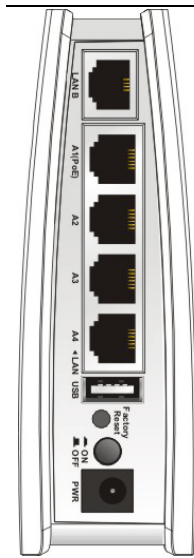

LED	Status	Explanation
ACT	Off	The system is not ready or is failed.
	Blinking	The system is ready and can work normally.
USB	On	A USB device is connected and active.
	Blinking	The data is transmitting.
LAN B	On	A normal connection is through its corresponding port.
	Off	LAN is disconnected.
	Blinking	Data is transmitting (sending/receiving).
LAN A1 - A4	On	A normal connection is through its corresponding port.
	Off	LAN is disconnected.
	Blinking	Data is transmitting (sending/receiving).
WLAN (Green LED) on WLAN button	On	Wireless function is ready.
	Off	Wireless function is not ready.
	Blinking (Green)	Data is transmitting (sending/receiving).
WPS (Orange LED) on WLAN button	Off	The WPS is off.
	Blinking (Orange)	Blink with 1 second cycle for 2 minutes - - WPS is enabled and waiting for wireless client to connect with it.
	Blinking (Orange)	Data is transmitting (sending/receiving).
WPS Button	Press this button for 2 seconds to wait for client device making network connection through WPS. When the orange LED lights up, the WPS will be on.	



Interface	Description
LAN B	Connector for xDSL / Cable modem or router.
LAN A1 (PoE) - A4	Connector for xDSL / Cable modem or router.
USB	Connector for future use.
	Restore the default settings. Usage: Turn on the router. Press the button and keep for more than 10 seconds. Then the router will restart with the factory default configuration.
	ON/OFF: Power switch. PWR: Connector for a power adapter.

# 3

## Installing Your Router

This section will guide you to install the AP through hardware connection and configure the settings through web browser.

Before starting to configure the router, you have to connect your devices correctly.

1. Connect VigorAP 800 to ADSL modem, router, or switch/hub in your network through the **LAN A** port of the access point by Ethernet cable.

***Note:** You can also connect VigorAP 800 to a Vigor router via wireless connection. For detailed information, refer to VigorAP 800 User's Guide.*

2. Connect a computer to other available LAN A port. Make sure the subnet IP address of the PC is the same as VigorAP 800 management IP, e.g., **192.168.1.X**.
3. Connect the A/C power adapter to the wall socket, and then connect it to the PWR connector of the access point.
4. Power on VigorAP 800.
5. Check all LEDs on the front panel. **ACT** LED should be steadily on, **LAN** LEDs should be on if the access point is correctly connected to the ADSL modem, router or switch/hub.

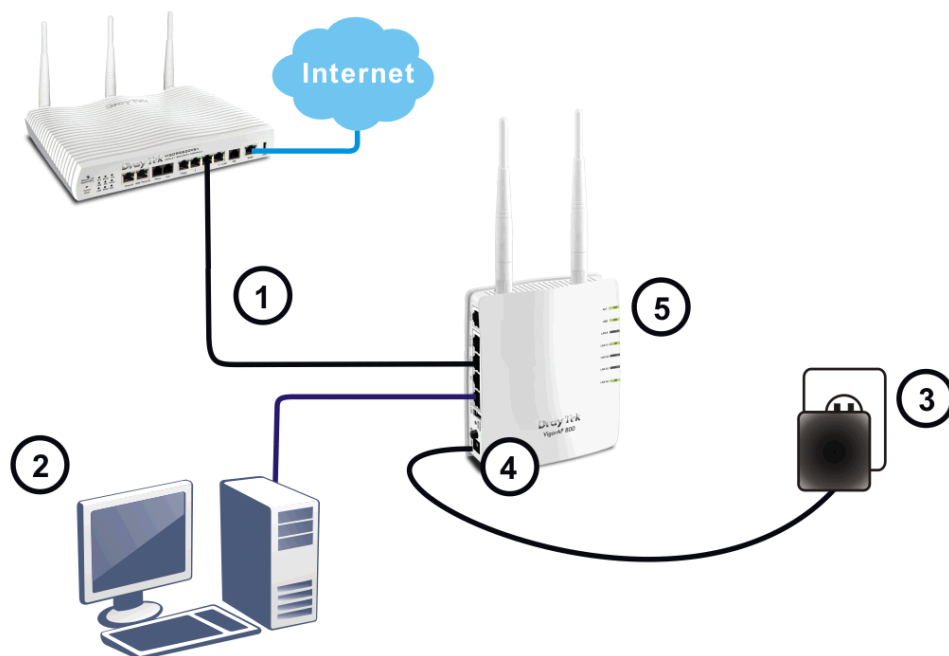

# 4

## Configuring Web Pages

The **Operation Mode** is designed for you to easily set up your router for Internet access.

1. Make sure your PC connects to the router correctly.
2. Open a web browser on your PC and type **http://192.168.1.2**. A pop-up window will open to ask for username and password. Please type “admin/admin” on Username/Password and click **Login**.



Connect to 192.168.1.2

VigorAP800

User name: admin

Password: \*\*\*\*\*

Remember my password

OK Cancel

3. The **Main Screen** will pop up. Click **Operation Mode**.

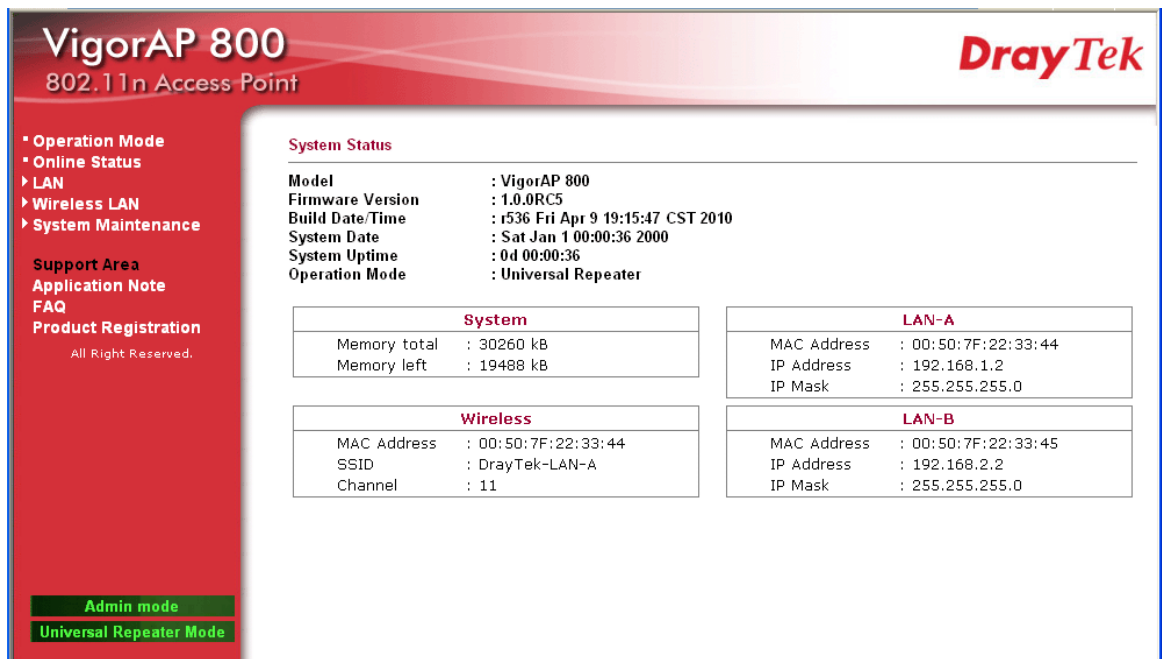

VigorAP 800  
802.11n Access Point

DrayTek

- Operation Mode
- Online Status
- ▶ LAN
- ▶ Wireless LAN
- ▶ System Maintenance
- Support Area
- Application Note
- FAQ
- Product Registration

All Right Reserved.

Admin mode

Universal Repeater Mode

**System Status**

Model : VigorAP 800  
Firmware Version : 1.0.0RC5  
Build Date/Time : r536 Fri Apr 9 19:15:47 CST 2010  
System Date : Sat Jan 1 00:00:36 2000  
System Uptime : 0d 00:00:36  
Operation Mode : Universal Repeater

System	
Memory total	: 30260 kB
Memory left	: 19488 kB

LAN-A	
MAC Address	: 00:50:7F:22:33:44
IP Address	: 192.168.1.2
IP Mask	: 255.255.255.0

Wireless	
MAC Address	: 00:50:7F:22:33:44
SSID	: DrayTek-LAN-A
Channel	: 11

LAN-B	
MAC Address	: 00:50:7F:22:33:45
IP Address	: 192.168.2.2
IP Mask	: 255.255.255.0

4. There are six operation modes for you to choose. Simply click any one of them and click **OK**. In this example, choose **AP**.

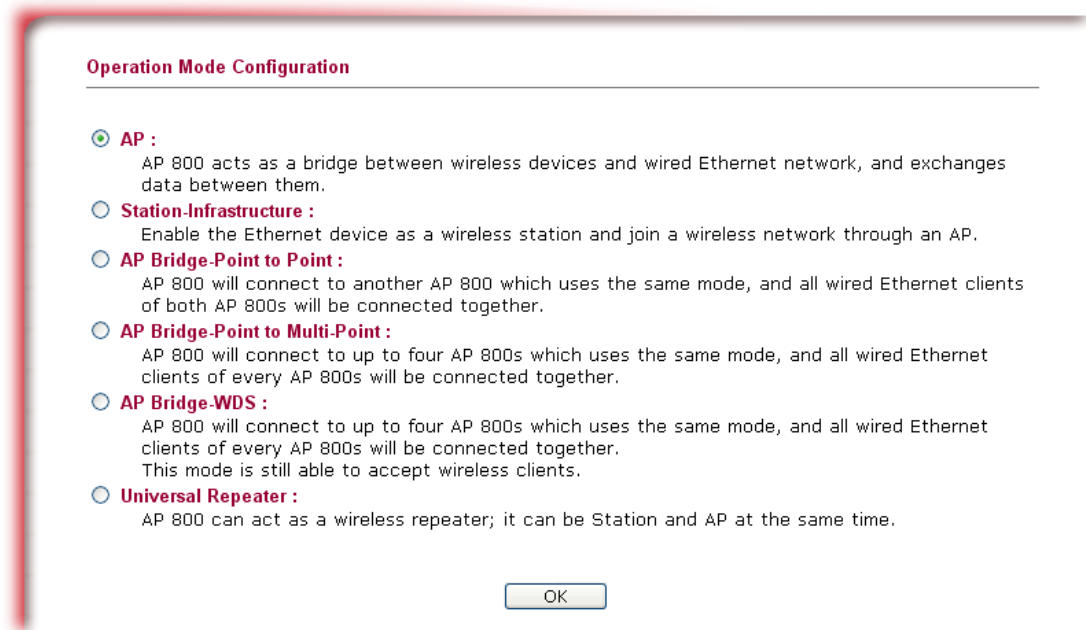

5. The system will make a connection automatically. Open **Online Status** to see the result of network connection.

**Online Status**

---

**System Status** **System Uptime: 0d 00:57:44**

<b>LAN-A Status</b>				
<b>IP Address</b>	<b>TX Packets</b>	<b>RX Packets</b>	<b>TX Bytes</b>	<b>RX Bytes</b>
192.168.1.2	26424	22859	21301411	2183168

<b>LAN-B Status</b>				
<b>IP Address</b>	<b>TX Packets</b>	<b>RX Packets</b>	<b>TX Bytes</b>	<b>RX Bytes</b>
192.168.2.2	0	0	0	0

Now, VigorAP 800 is ready for any station to connect for accessing Internet.

## Contacting Your Dealer

If the router still cannot work correctly after trying many efforts, please contact your dealer for further help right away. For any questions, please feel free to send e-mail to [support@draytek.com](mailto:support@draytek.com).