



AP-GS1001™

1-Port FXS GSM Gateway

High Performance GSM Gateway Solution

Preliminary Product Overview

(Without notice, following described technical spec. can be changed)

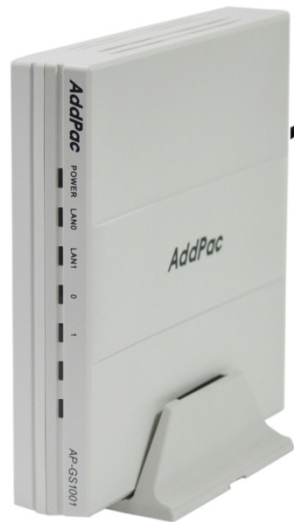

AddPac

AddPac Technology

2010, Sales and Marketing

www.addpac.com

Contents

AP-GS1001 1-Port FXS GSM Gateway

- Product Overview
- Hardware Specification
- GSM Module Specification
- APOS Technology
- VoIP (Voice over IP) service
- Advanced QoS Features
- Network Protocols
- Network Management
- Smart Web Management
- Security Management
- Application Service
- Ordering Information

Product Overview

AP-GS1001 1-Port FXS GSM Gateway

- Analog Interface (FXS)/VoIP Interface(LAN) Both Support
- H.323/SIP/MGCP Triple Concurrent Stack Embedded
- High Performance RISC & Programmable DSP Architecture
- Two(2) 10/100Mbps Fast Ethernet (IP Share ,etc)
- High Performance LAN-to-LAN Routing Capability
- G.711/G.726/G.723/G.729, T.38 Fax , VAD, etc
- Powerful Network Protocols (PPPoE, DHCP, Static Routing, etc)
- Firmware Upgradeable Architecture
- VPMS (VoIP Plug&Play Management System) for Large Scale Deployment
- Advanced Voice QoS Mechanism
- Light and Compact Design with External Power Supply

Product Highlights

AP-GS1001 1-Port FXS GSM Gateway

Powerful GSM Gateway

State-of-art Signaling
H.323, SIP, MGCP
Concurrent Triple Stack

Light and
Compact Design

Analog FXS interface,
VoIP Interface Both
Support

High Performance RISC CPU
+ Programmable DSP

Excellent Voice Quality
G.729/G.723/G726/G711

Broadband IP Networking
With dual 10/100Mbps
Fast Ethernet

APOS™ Technology
Firmware Upgradeable Architecture

VPMS Large Scale VoIP
Gateway Management Support

Powerful Network Protocol
Support

Powerful Trouble Shooting &
Debugging Feature Support

Advanced Voice
Traffic QoS Mechanism

AddPac

www.addpac.com

APOS Technology

AP-GS1001 1-Port FXS GSM Gateway

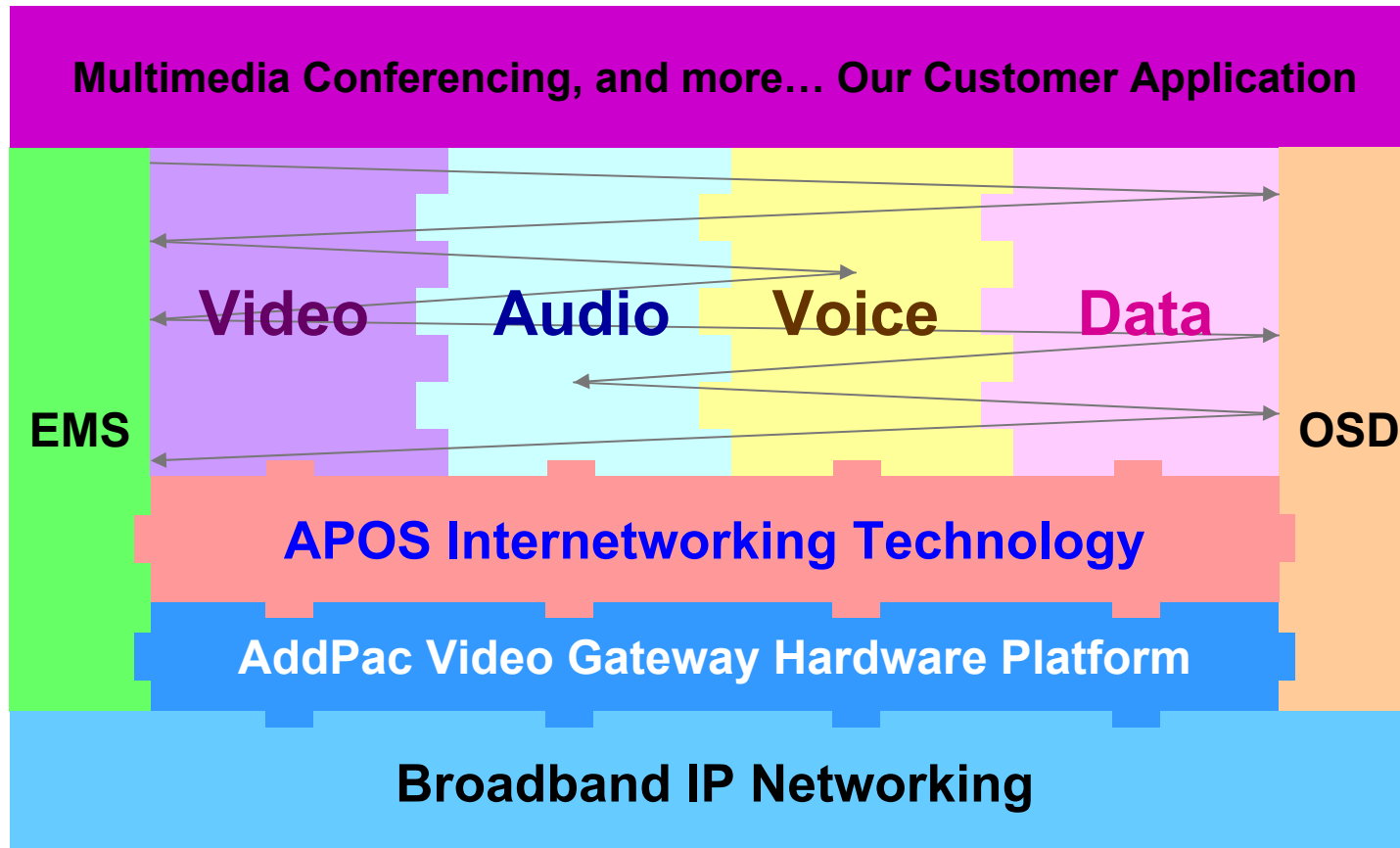

- APOS : AddPac Internetworking Operating System
- OSD : On- Screen Display
- EMS : Element Management System

Hardware Specification

AP-GS1001 1-Port FXS GSM Gateway

RISC
CPU

High-end
DSP

- **RISC Microprocessor Computing Power**
- **1-Port GSM Gateway**
- **1-Port SIM Card Slot**
- **1-Port GSM Antenna Interface**
- **VoIP Gateway Interface**
 - AP-GS1001 Model A: Basic Configuration
 - AP-GS1001 Model B: One(1) FXS Port
- **Network Interface for VoIP Direct Interface**
 - Two(2) 10/100Mbps Fast Ethernet (RJ45)
- **Run LED, LAN LED, Port LEDs**
- **External Power Supply**

Hardware Specification

AP-GS1001 1-Port FXS GSM Gateway

RISC
CPU

High-end
DSP

GSM Gateway Service Diagram

AP-GS1001 GSM Gateway Internal H/W Block Diagram

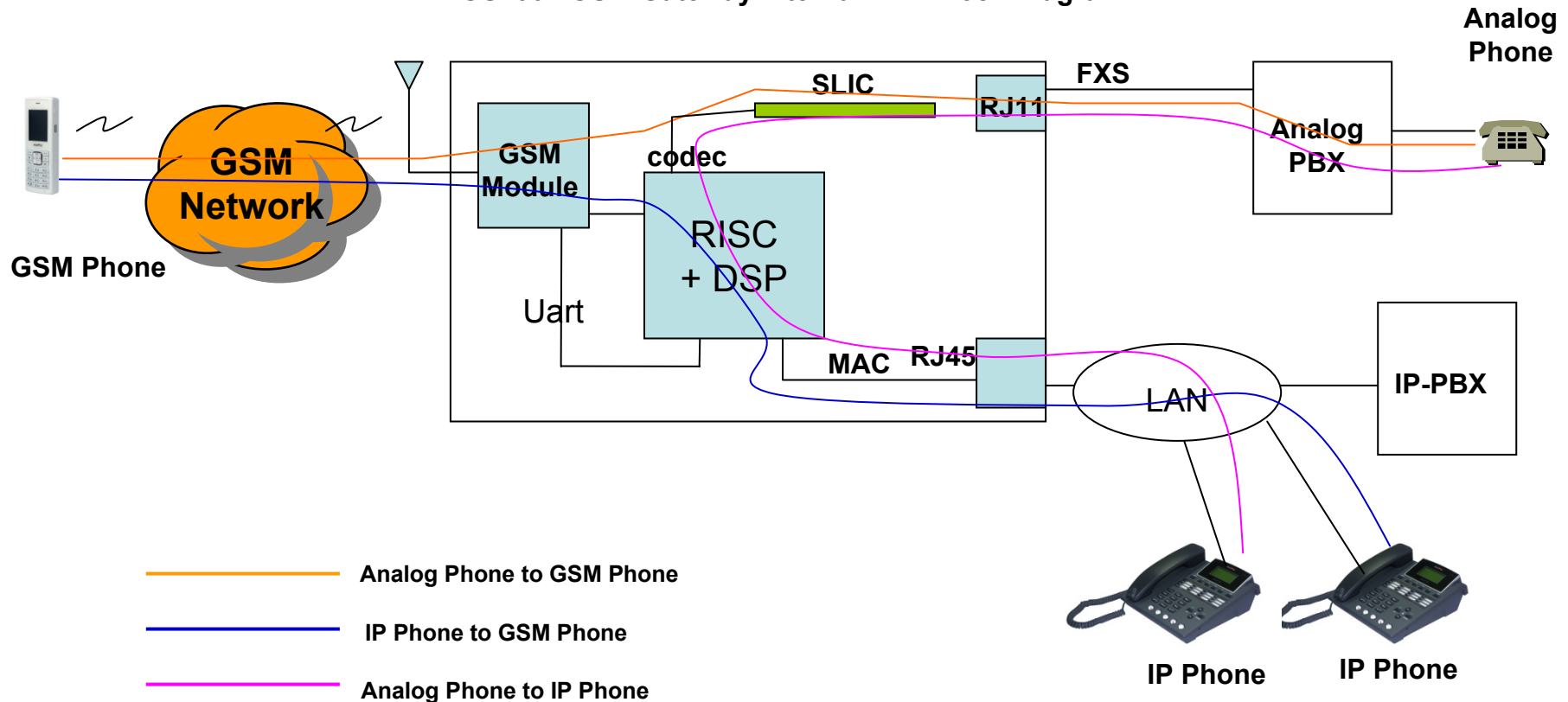

Hardware Specification

AP-GS1001 1-Port FXS GSM Gateway

Hardware Specifications

AP-GS1001 GSM Gateway	Basic Specifications
Voice Interface	No FXS Port : Model A
	One(1)-Port FXS Analog Interface : Model B
GSM Antenna Interface	External GSM Antenna
SIM Card Slot Interface	GSM SIM Card Slot
Ethernet Interface	2-Ports 10/100Mbps Ethernet Interface(RJ-45)
Flash Memory	4Mbyte High-speed Flash Memory
Base Memory	32 Mbyte High-speed SDRAM
Power Requirement	Power Supply Adaptor / VAC 110~220V, 50/60Hz, 5V, 2A
Operating Temperature	0°C ~ 45°C (32 °F ~ 122°F)
Storage Temperature	-40°C ~ 85°C (-40°C ~ 185°F)
Relative Humidity	5% ~ 95% (Non-condensing)
Dimension	142mm x 142mm x 28mm (W x D x H)
Weight (Kg)	0.42Kg

Network interface Configurations

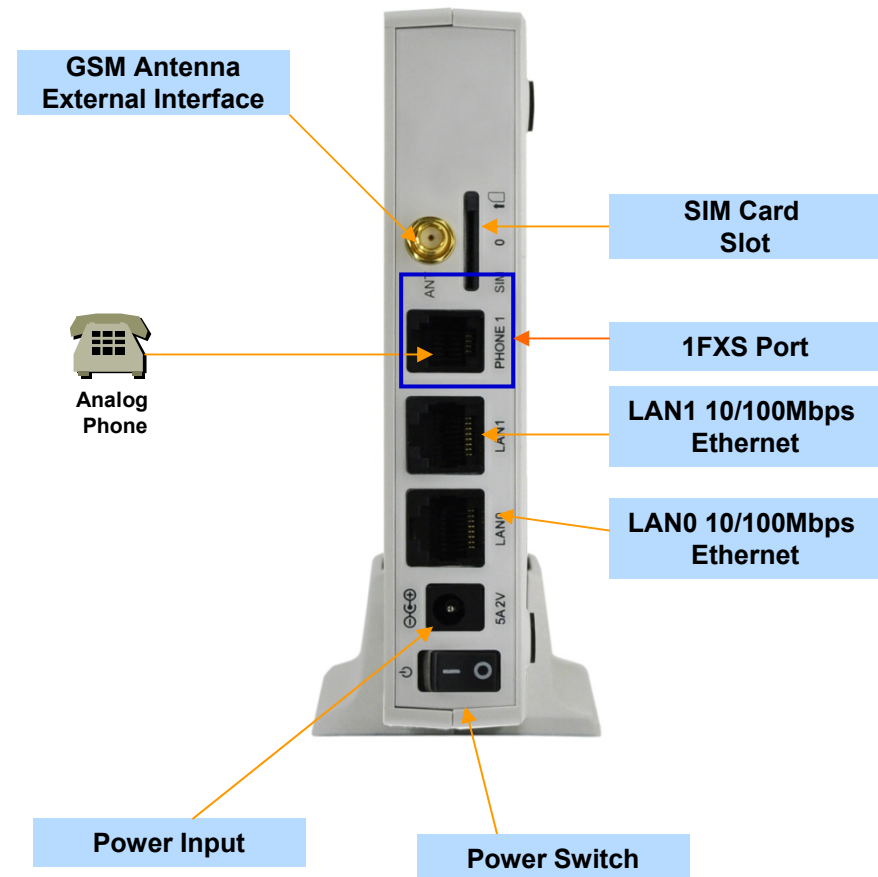

GSM Module Specification

AP-GS1001 1-Port FXS GSM Gateway

- Bearers : GSM + GPRS class 10
- Quad-Band EGSM 850/900/1800/1900MHz
- Normal Sensitivity
 - 850MHz Rx -104 dBm
 - 900MHz Rx -104 dBm
 - 1800MHz Rx -102 dBm
 - 1900MHz Rx -102 dBm
- Tx Performances
 - 850MHz Tx +33 dBm
 - 900MHz Tx +33 dBm
 - 1800MHz Tx +30 dBm
 - 1900MHz Tx +30 dBm
- Power Consumption
 - 17 uA Sleep Mode, 1.7mA Idle Mode, 400mA GPRS class10 (33 dBm)
- Codec
 - FR-EFR-HR-AMR

VoIP (Voice over IP) Service

AP-GS1001 2-Port FXS GSM Gateway

- H.323, SIP, and MGCP Triple Stack
- H.323
 - ITU-T Standard H.323 v3 Support
 - Support H.245 Tunneling
 - Including H.235 Security Features
- SIP
 - IETF RFC3261 or RFC2543 SIP Standard
- MGCP
 - IETF RFC2705bis-02 Standard MGCP 1.0



VoIP (Voice over IP) Service

AP-GS1001 1-Port FXS GSM Gateway

- **H.323**

- Fast connect, normal connect support
- H.245 tunneling support
- Q.931 response message setting for inbound VoIP calls
- H.245 logical channel open timing selection function
- Start H.245 procedure support
- DTMF / Hook flash relay with H.245 alphanumeric / signal
- Secondary gatekeeper support
- Gatekeeper assignment according to the domain name
- Gatekeeper discovery with multicast
- Lightweight RRQ support
- Signaling TCP port assignment
- Resource threshold setting with RAI
- H.235 clear-token, crypto-token support
- canMapAlias support
- Technical prefix (supported prefix) support
- Public IP assignment in NAT environment

- **SIP**

- Gateway-based / Endpoint-based registration support
- Secondary proxy-server assignment function
- SIP signaling port change function
- SIP proxy server assignment according to the domain name
- T.38 real-time fax relay support
- DTMF relay support with RFC2833 / OPTION message
- Re-INVITE support

- **MGCP**

- Secondary call agent assignment function
- Default package assignment
- Announcement Server Package, Generic Media Package, Handset Package, Line Package, Trunk Package support
- MGCP call agent assignment according to the domain name
- T.38 real-time fax relay support
- DTMF relay support based on RFC2833

VoIP (Voice over IP) Service

AP-GS1001 1-Port FXS GSM Gateway

- **Voice Codec**

- G.711 A-Law, G.711 U-Law
- G.726 r16, G.726 r32
- G.729A
- G.723.1 r63, G.723.1 r53
- VAD (Voice Activity Detection) function support
- DTMF relay support (H.323, SIP, MGCP common) based on RFC2833

- **RTP**

- Redundant RTP packet transmission in case of severe packet loss
- Dynamic jitter buffer management and RTP packet jitter and loss compensation with heuristic & DSP error concealment
- Static jitter buffer setting support
- Voice frame per RTP packet number control for each codec
- In-band ring-back tone support
- Virtual ring-back tone support
- Tone parameter change support

- **FAX**

- Fax relay mode supporting T.38, inband-T.38, bypass mode
- Lost packet compensation with redundant setting in case of T.38 fax relay
- Fax relay mode, rate setting for remote end

VoIP

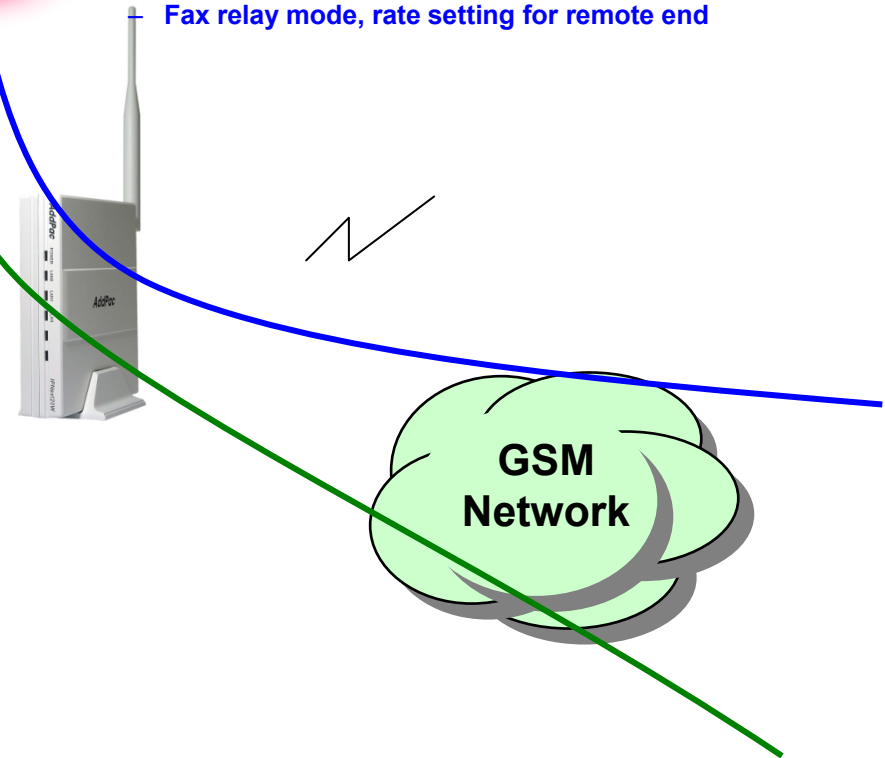

VoIP (Voice over IP) Service

AP-GS1001 1-Port FXS GSM Gateway

• VoIP Call Controls

- Hot line connection function with PLAR (Private Line Auto Ring Down)
- Leased line emulation function
- Connection monitoring function
- Fault tolerant with Redundancy and Call Distribution among Gateways for load balancing
- Call attempt with IP address
- H.323, SIP, MGCP inbound call connection for each voice port
- Multiple E.164 setting for one voice port
- One E.164 or digit pattern can be assigned to more than one voice port
- Hunting with Longest match/ priority/ sequence/ random
- One stage call setup by Digit forwarding
- Call barring with specific digit patterns
- Calling and called number conversion for PSTN outbound calls
- PSTN rerouting in case of VoIP call attempt failure

• VoIP Call Controls (cont.)

- Call transfer for internal calls
- Call pickup for internal calls
- Calling and called number conversion for VoIP outbound calls
- Calling and called number conversion for VoIP inbound calls
- Fax broadcasting call control

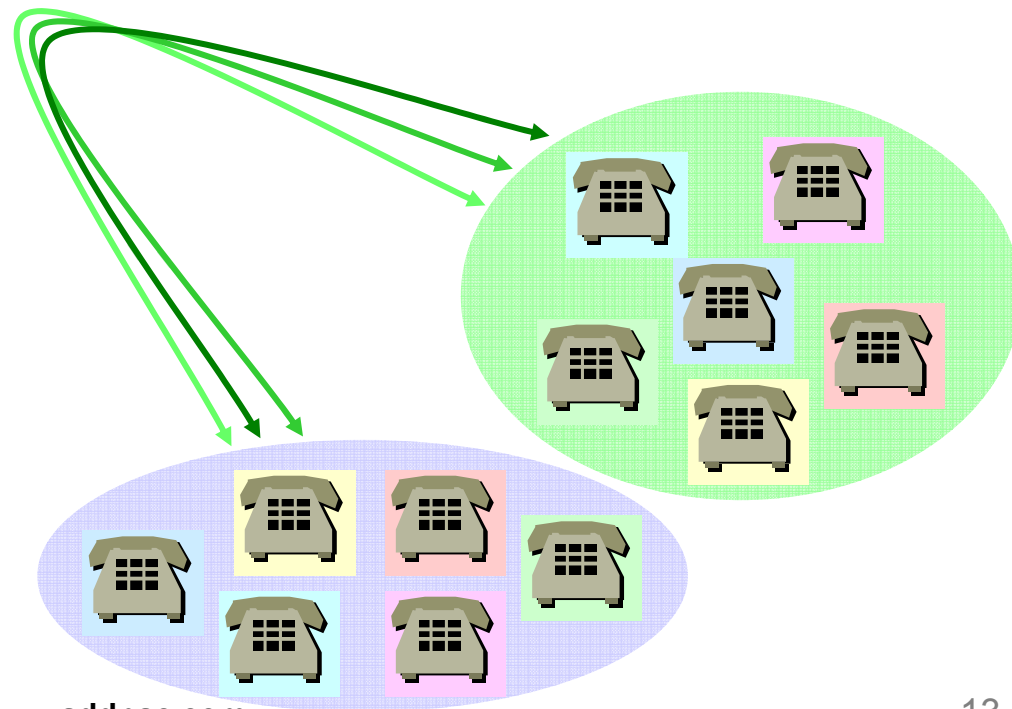

Advanced QoS Features

AP-GS1001 1-Port FXS GSM Gateway

- Enhances **Transmit** Voice QoS Features
 - Voice Traffic Priority Queuing
 - QoS Service Profiling
 - Providing Virtual Network Transmit Algorithm
 - Real-time Voice Traffic QoS Support
 - RTP Packet Transmit Interval Control
 - Supporting RTP Packet Redundancy Scheme
 - IP Header Control such as ToS, Diffserv
- Enhances **Receive** Voice QoS Features
 - Dynamic Jitter Buffer Management
 - Error Concealment
 - Support T.38 FAX Data Error Recovery Scheme

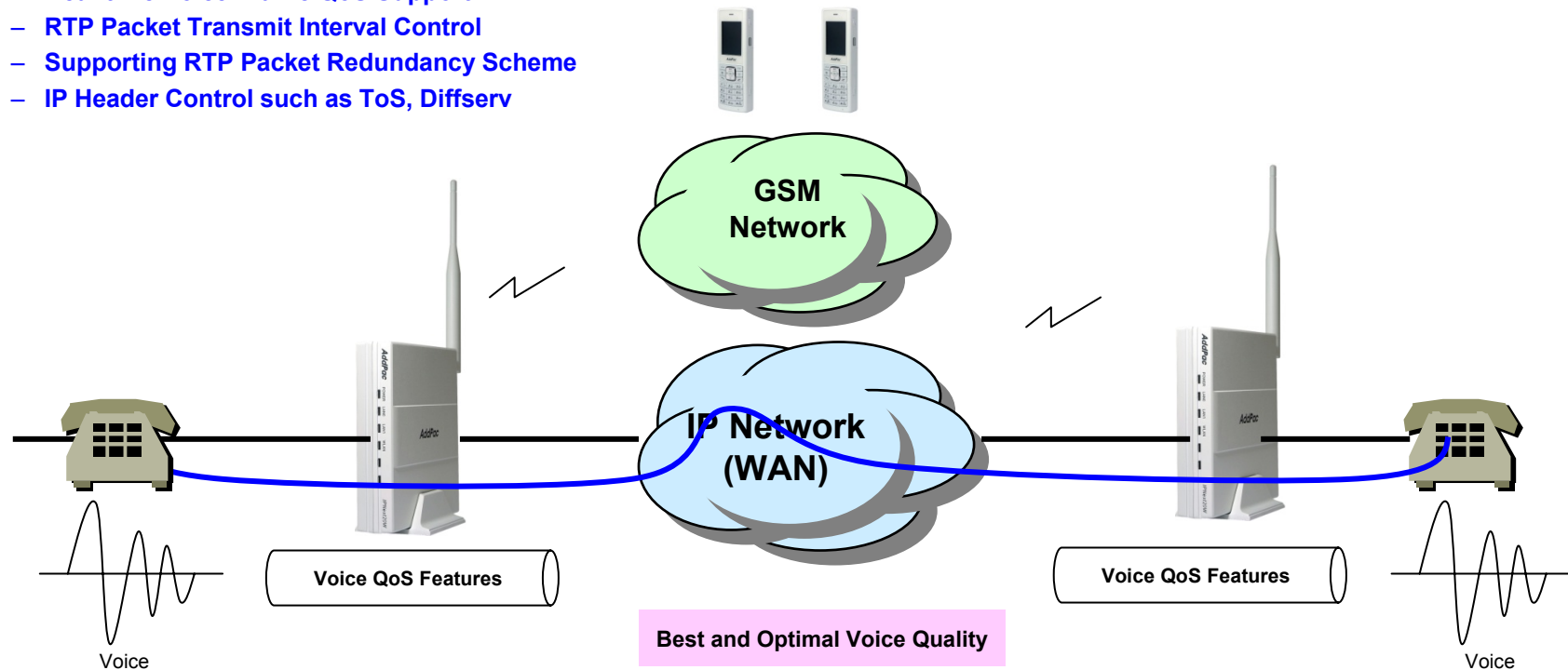

Network Protocols

AP-GS1001 1-Port FXS GSM Gateway

Basic Network Protocols

- ARP, IPv4, TCP, UDP, ICMP, SCTP, IGMP, MLD

Routing Protocol

- IPv4 : Static

Service Protocol

- FTP, Telnet, TFTP, DHCP Server/Relay, SNMP Server
- CDP (Cisco Discovery Protocol)
- DNS Resolver , DDNS(nsupdate)
- Bridge
- Syslog

IPv4 Address Configuration

- Fixed (Static)
- DHCP
- PPPoE

Miscellaneous

- Cisco Style CLI
- Standard & Extended IPv4 Access List
- Multi-level User Account Management
- IP accounting
- STUN Client

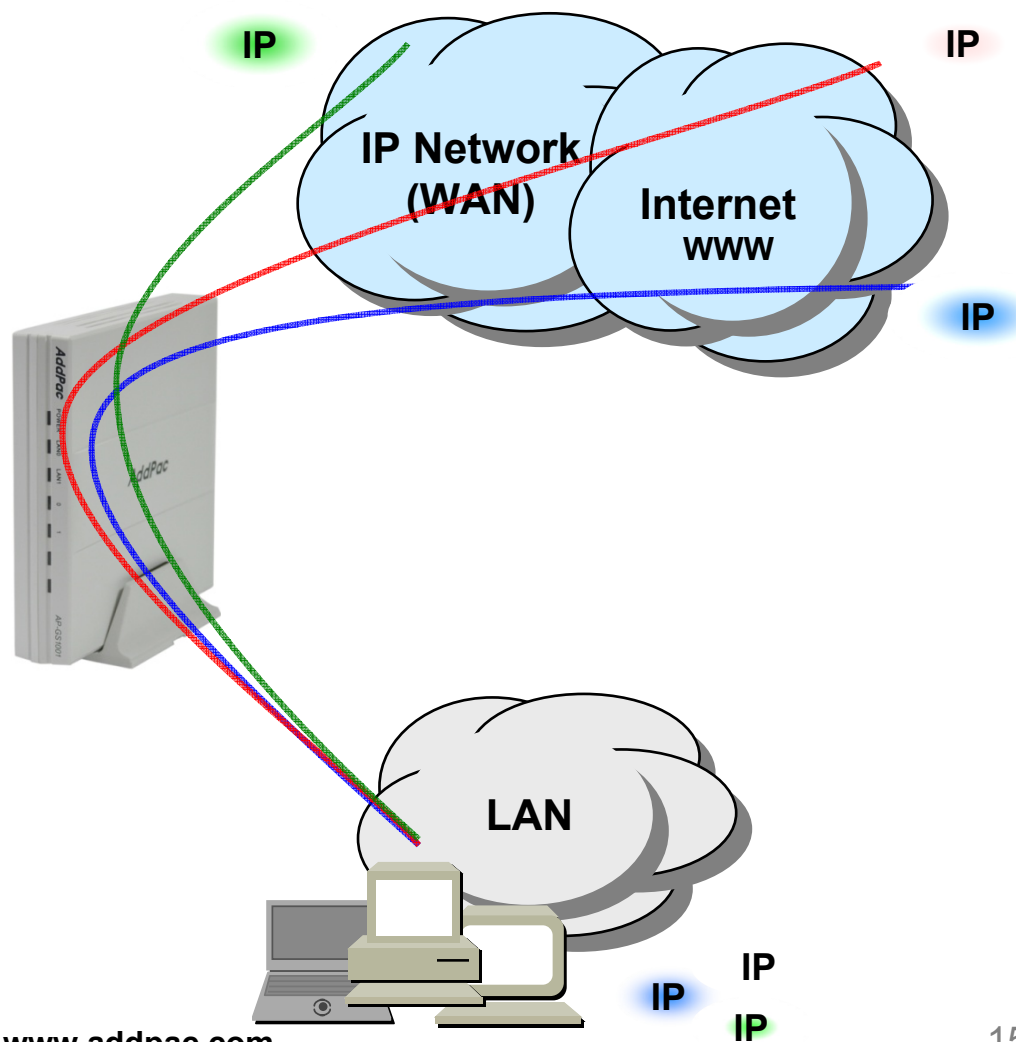

Network Management

AP-GS1001 1-Port FXS GSM Gateway

- **SNMP**

- Standard Simple Network Management Protocol(SNMP) Agent support
- MIB v1 and v2 Support

- **Web-based Management**

- Smart Easy Setup
- Standard Voice Interface
- Standard PSTN Back-up Interface

- **Watch-dog Function**

- Hardware, Software watch-dog services

- **Remote Management**

- Telnet
- Rlogin

- **Auto Upgrade Service**

- HTTP server based APOS image and configuration file auto-upgrade support

- **Batch Job Function**

- Text based script downloading

- **Interoperable with AP-VPMS Service**

- AddPac VoIP Plug & Play Management System (AP-VPMS)

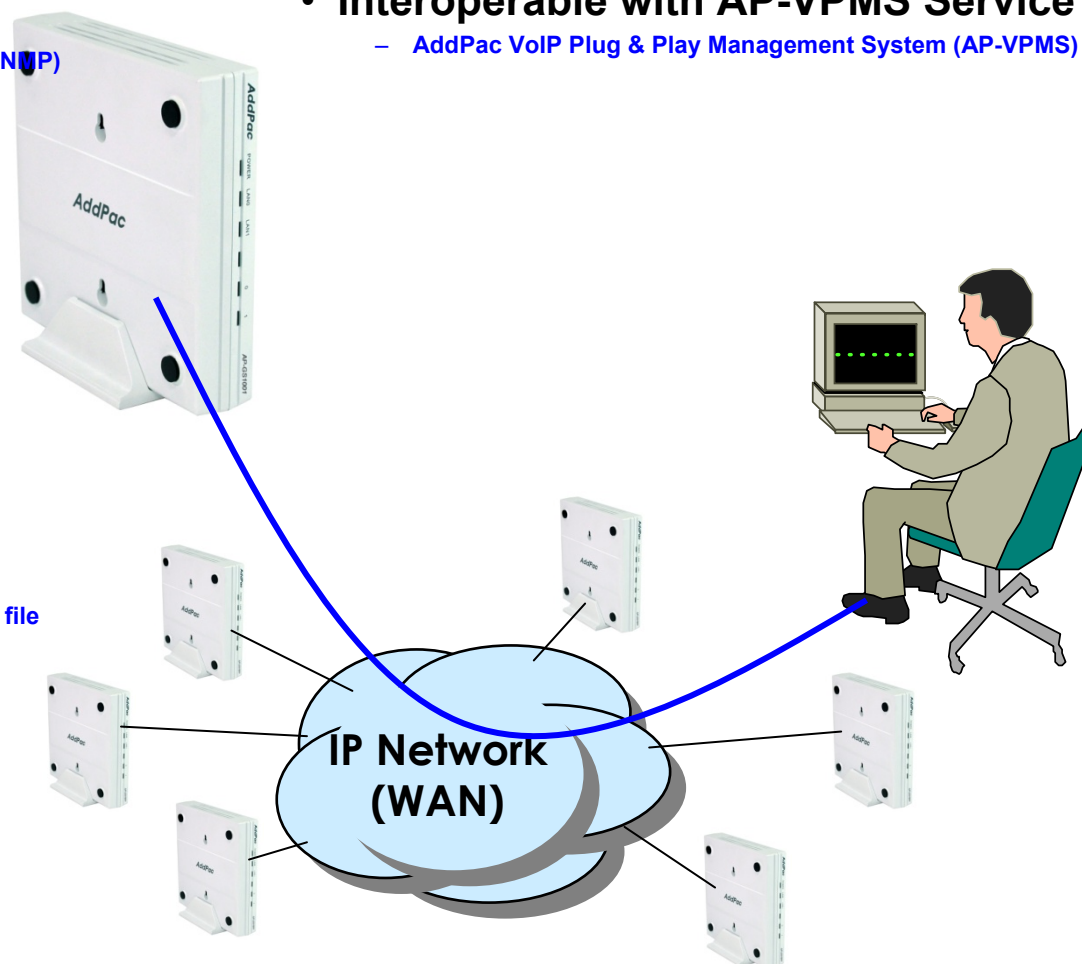

Smart Web Manager : Main Page Layout

AP-GS1001 1-Port FXS GSM Gateway

Main Menu
For easy system setup, provide the various menu and category

- System
 - Network Setup
 - Language
 - NTP
 - Backup/Restore
- Basic
 - Protocol
 - Server SIP
 - Server H.323
 - Tel Number
 - FXS/FXO/E1 Group
 - E1 Trunk
 - DTMF/CODEC
 - Dial Plan/Prefix
 - Static Route
 - Hot Line
- Advanced
 - Gain
 - Fax
 - Service
 - Filtering
 - Security
 - SNMP
- Miscellaneous
 - Call Status
 - System Status
 - Alarm Status
 - Call Log
 - System Log
 - Test Call
 - Ping

Tool Bar
Provide frequently used tools like as System Update, Configuration Backup, Initialization, Restart, Telnet

System Information

HW Version	2.0
SW Version	ap1800k_web_g2_v8_47T.bin 8.47
MAC Address	0002.a511.2245
VoIP Protocol	SIP
Voice Interface Module	S(4)O(4) : E1(2)
Registration Status	Unregistered
Supported Codec List	g711alaw g711ulaw g7231r53 g7231r63 g726r32 g729
Network Information	Static 172.16.50.114
WAN LINK Status	100Mbps FULL Duplex Link UP
LAN LINK Status	Link Down
Current Time	Thu Oct 1 13:06:23 2009
System Startup Time	Thu Oct 1 12:56:46 2009
System Running Time	0 days 00:09:37
Total Calls	0

Information
Display the current system version and status summery

AddPac Tehonology
Model : AP1800K_G2
H/W Version : 2.0
S/W Version : 8.47
Smart Web Version : 0.3
Smart Web Build : Oct 1 2009
Voice Interface
S(4)O(4) : E1(2)
Protocol : SIP
Status : Unregistered
CurrentCalls : 0 Call
Network : Static 172.16.50.114
Mac Address: 0002.a511.2245

Description
WAN 포트에 대한 설정입니다. Static IP의 경우 고정 IP 주소로 사업자로부터 할당 받은 주소 정보를 입력합니다. DHCP와 PPPoE의 경우 유동 IP로 장비의 주소가 변경될 수 있습니다. DHCP 및 PPPoE는 사용자 환경에 맞도록 설정하십시오. MAC 주소 변경은 필요시 장비에 설정된 주소를 사용하지 않고 사용자가 설정한 주소를 사용하는 방안으로 반드시 필요한 경우에 한하여 사용해야 합니다.

Workspace
Workspace for detailed action

Description
Display the help message if you move mouse over main menu

©AddPac Tehonology 2008-2009. all rights reserved.

Smart Web Manager : E1 Trunk Configuration (Example)

AP-GS1001 1-Port FXS GSM Gateway

E1 Port
E1 Port Configuration
Example : Slot is selected by tap button. Group in each E1 port can be added or deleted.

E1 Port Configuration
Provide the detailed configuration menu about selected E1 port

Tool Tip
Display the help message according to mouse move

Smart Web Manager
www.addpac.com

E1 Trunk

Slot 1/0 Slot 1/1

Slot/Port	group Num (0)	Time slot Range(1-31,16-31,1,2,3)	Control
1/0	0	1-31	Delete
1/0	<input type="text" value="0"/>	<input type="text"/>	Add

E1 Port (Slot 1/0)

Clock-Source: Slave

Signaling-type: ISDN-PRI

ISDN-PRI

Protocol-emulate: Network User

Virtual-Connect: Enable Disable

Immediate-disc: Enable Disable

Dial-Tone-Generate: Enable Disable

Comband-Type: a-law u-law

Q931 Timer

N303: (1-10sec)

T303: (1-400sec)

T310: (5-400sec)

R2-MFC: Get-Calling-number: Enable Disable

Busycout: Action

Apply

Information

AddPac Tehonology
Model : AP1800K_G2
H/W Version : 2.0
S/W Version : 8.47
Smart Web Version : 0.3
Smart Web Build : Oct 1 2009
Voice Interface
S(4)O(4) : E1(2)
Protocol : SIP
Status : Unregistered
CurrentCalls : 0 Call
Network : Static 172.16.50.114
Mac Address : 0002.a511.2245

Description

E1 포트별 동작 방법을 설정합니다.

Get-Calling-number

enable로 체크해 주어야 할 내용으로 사설 교환기로 부터 발신번호 요청을 합니다.
R2 방식일 경우에는 발신자 번호를 대국측에서 요청을 하여야만 받을 수 있습니다.
기본적으로 R2 pdd 값을 줄이기 위해서 초기 값은 0으로 설정되어 있습니다.

©AddPac Tehonology 2008-2009. all rights reserved.

Smart Web Manager : Call Status (Example)

AP-GS1001 1-Port FXS GSM Gateway

E1 Port

Real-time display about digital E1 time slot status (idle, dialing, incoming call, outgoing call, call blocking, etc)
Provide a specific port blocking function

Analog Port

Real-time display about analog port status (occupation, call status).
Provide a specific port blocking function

Port Status Display

Active Call Status

Real-time display about current active call status (calling party addr, called party addr. Codec, etc)

The screenshot shows the Smart Web Manager interface with the 'Call Status' page selected. The interface includes a left sidebar with navigation menus for System, Basic, Advanced, and Miscellaneous. The main content area is divided into several sections:

- Port Status (E1):** A table showing digital E1 time slot status for SLOTS 1/0 and 1/1. Each slot has a 'Channel' row and a 'Status' row. The status row contains 31 columns representing time slots, with 'C' (Called) and 'I' (Idle) indicators.
- Port Status (Analog):** A table showing analog port status for SLOT 0. It has columns for 0(FXS) through 7(FXS) and rows for Status and Select. The status row shows 'C' (Called) for 0(FXS) and 'I' (Idle) for others.
- Legend:** A legend for port connection and call states. It includes: (Connected) (Disconnected || Blocked), (Idle) (Ring || Dial), (Called) (Calling), and (Blocked).
- Call Status:** A table showing the details of the current active call. The table has columns for Port, Direction, Established Time, Calling Number, Called Number, CODEC, and Src/Dest. IP. The active call entry shows: Port 1/0:30, Direction E1Local, Established Time 01/01 09:10:38, Calling Number 6404, Called Number 9000, CODEC g711u, and Src/Dest. IP N.A.

On the right side, there is an 'Information' section with details like Model (AP1800K_G2), HW Version (2.0), SW Version (8.47), and Network information. Below that is a 'Description' section with a note in Korean: '포트의 상태 정보를 확인하고 현재 통화 정보를 조회합니다.'

At the bottom of the interface, there is a copyright notice: ©AddPac Tehonology 2008-2009. all rights reserved.

Security Management

AP-GS1001 1-Port FXS GSM Gateway

- IP packet filtering
- IP access list
- User authentication function
 - Password Authentication Protocol (PAP)
 - Challenge Handshake Authentication Protocol (CHAP)
- Enable/Disable specific protocols
- Auto-square connect of Telnet session
- Account Management function for multi-level user
- SNMP/TELNET/FTP/HTTP/TFTP port assignment function
- SNMP/TELNET/FTP access list management
- Boot mode security checking function

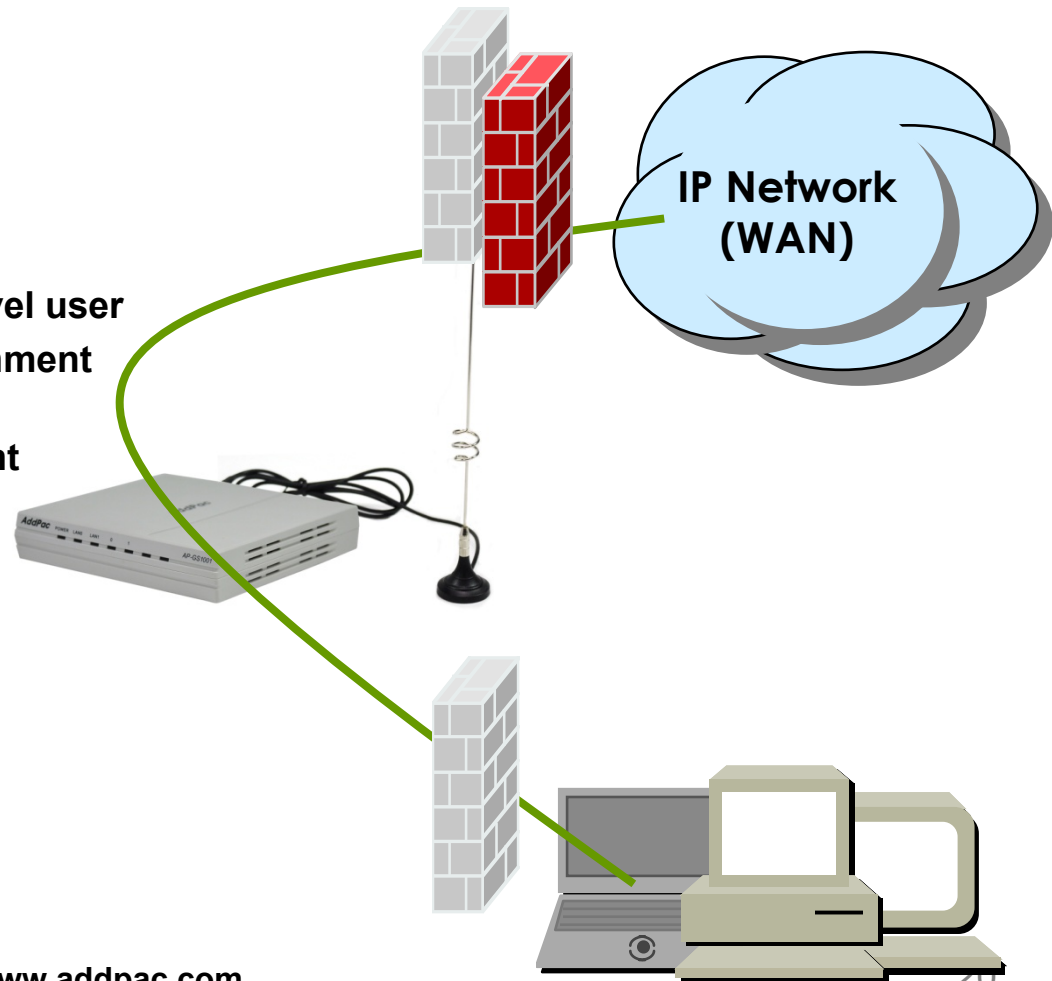

Standard Application

AP-GS1001 1-Port FXS GSM Gateway

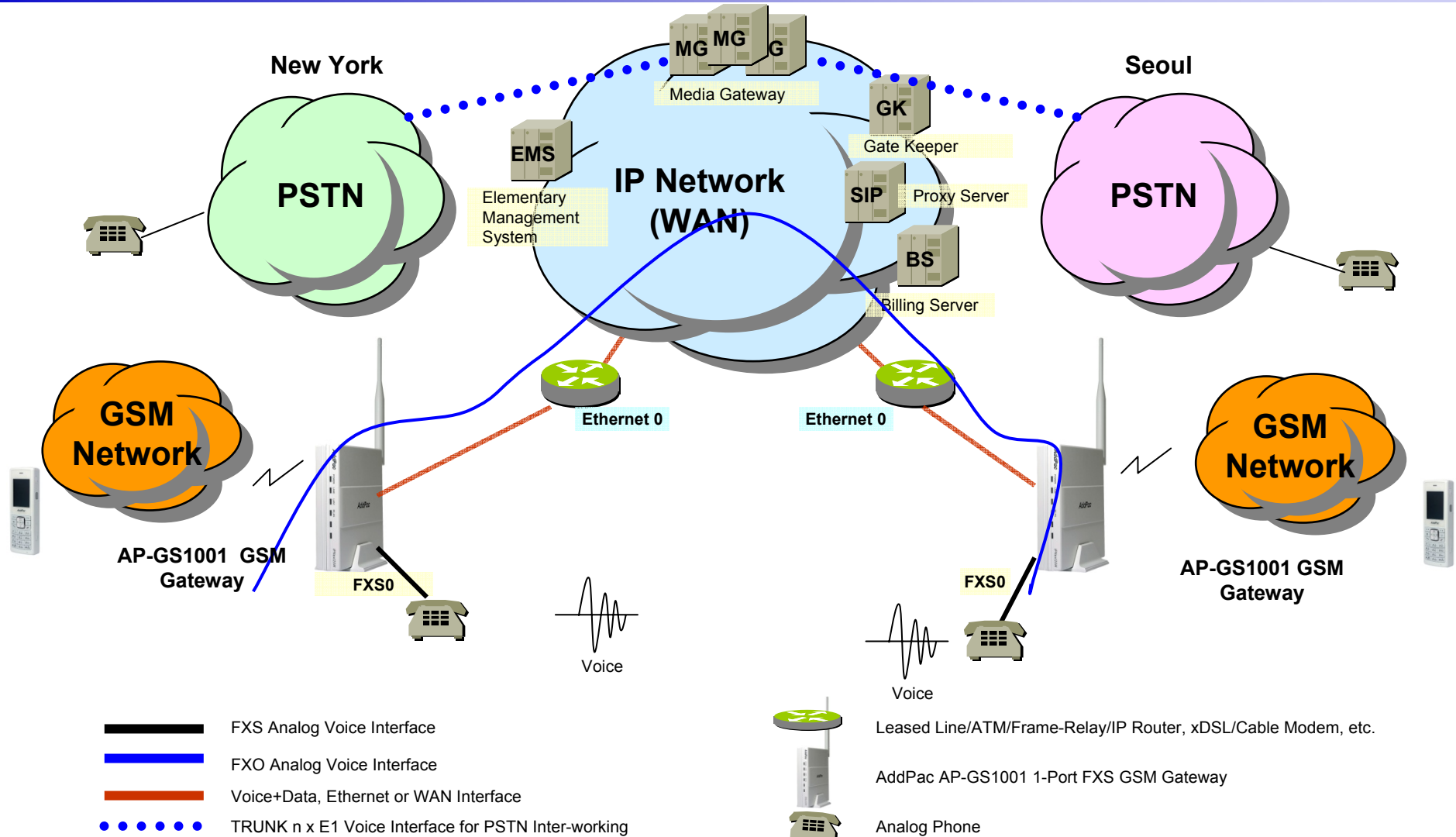

Ordering Information

- **AP-GS1001 GSM Gateway Hardware**
 - AP-GS1001 GSM Gateway Main Body
 - RISC Microprocessor with High-end Programmable DSP Architecture
 - 1-Port FXS Interface(1xRJ11)
 - 1-ports 10/100Mbps Fast Ethernet(RJ45)
 - Including Network Cable, Antenna & Ext. Power Supply, etc.
- **Built-in APOS Internetworking Software for AP-GS1001**
- **Including 1 Year Hardware Warranty**
- **Product Documents**
 - Install and Operation Guide (PDF)
- **Pricing**
 - AddPac Technology Regional Sales Manager
 - Authorized Sales and Marketing Representatives
 - Please Contact www.addpac.com

GSM Gateway Series

Thank you!

AddPac Technology Co., Ltd.
Sales and Marketing

Phone +82.2.568.3848 (KOREA)

FAX +82.2.568.3847 (KOREA)

E-mail sales@addpac.com